

HISTORY INFORMATION FOR THE FOLLOWING MANUAL:

# SERVICE MANUAL

# BA-6 CHASSIS

<u>MODEL NAME</u>	<u>REMOTE COMMANDER</u>	<u>DESTINATION</u>	<u>CHASSIS NO.</u>
<b>KV-13FS100</b>	RM-Y173	US	SCC-S61F-A
<b>KV-13FS100</b>	RM-Y173	CND	SCC-S59E-A
<b>KV-13FS110</b>	RM-Y173	US	SCC-S61E-A
<b>KV-13FS110</b>	RM-Y173	CND	SCC-S59F-A
<b>KV-14FV300</b>	RM-Y173	LATIN NORTH	SCC-S60M-A
<b>KV-14FV300</b>	RM-Y173	LATIN SOUTH	SCC-S60N-A

**ORIGINAL MANUAL ISSUE DATE: 7/2002**

ALL REVISIONS AND UPDATES TO THE ORIGINAL MANUAL ARE APPENDED TO THE END OF THE PDF FILE.

<u>REVISION DATE</u>	<u>REVISION TYPE</u>	<u>SUBJECT</u>
7/2002		No revisions or updates are applicable at this time.
9/2002	Correction -1	Added step #4 to 2-4. SCREEN (G2) instructions
4/2003	Correction -2	Replaced A Board Transistor Voltage List (Q600, Q601) (Page 31) Replaced A Board IC Voltage List (IC600) (Page 31)..
11/2003	Correction -3	Replaced A Board Schematic to correct T603 PIN Connection (Page 31)

TRINITRON® COLOR TELEVISION  
**SONY®**

# SERVICE MANUAL

# BA-6 CHASSIS

<u>MODEL NAME</u>	<u>REMOTE COMMANDER</u>	<u>DESTINATION</u>	<u>CHASSIS NO.</u>
<b>KV-13FS100</b>	RM-Y173	US	SCC-S61F-A
<b>KV-13FS100</b>	RM-Y173	CND	SCC-S59E-A
<b>KV-13FS110</b>	RM-Y173	US	SCC-S61E-A
<b>KV-13FS110</b>	RM-Y173	CND	SCC-S59F-A
<b>KV-14FV300</b>	RM-Y173	LATIN NORTH	SCC-S60M-A
<b>KV-14FV300</b>	RM-Y173	LATIN SOUTH	SCC-S60N-A



KV-13FS100



RM-Y173

TRINITRON® COLOR TELEVISION  
**SONY®**

# TABLE OF CONTENTS

SECTION TITLE	PAGE
Specifications.....	4
Warnings and Cautions .....	5
Safety Check-Out.....	6
Self-Diagnostic Function.....	7
<b>1. Disassembly</b>	
1-1. Rear Cover Removal.....	9
1-2. Chassis Assembly Removal .....	9
1-3. Service Position .....	9
1-4. Picture Tube Removal .....	10
Anode Cap Removal Procedure.....	10
<b>2. Set-Up Adjustments</b>	
2-1. Beam Landing.....	11
2-2. Convergence.....	12
2-3. Focus .....	13
2-4. Screen (G2) .....	13
2-5. Method of Setting the Service Adjustment Mode.....	14
2-6. White Balance Adjustments .....	14
<b>3. Safety Related Adjustments</b>	
3-1. <input checked="" type="checkbox"/> R565 Confirmation Method (HV Hold Down Confirmation) and Readjustments.....	15
3-2. B+ Voltage Confirmation and Adjustment .....	15
<b>4. Circuit Adjustments</b>	
4-1. Setting the Service Adjustment Mode.....	17
4-2. Memory Write Confirmation Method .....	17
4-3. Remote Adjustment Buttons and Indicators .....	17
4-4. ID Map Table .....	26
4-5. A Board Adjustments .....	26
<b>5. Diagrams</b>	
5-1. Circuit Boards Location .....	29
5-2. Printed Wiring Board and Schematic Diagram Information .....	29
5-3. Block Diagrams .....	30
5-4. Schematics and Supporting Information.....	31
A Board Schematic Diagram .....	31
C Board Schematic Diagram.....	33
M Board Schematic Diagram .....	35
HR Board Schematic Diagram .....	37
5-5. Semiconductors .....	38
<b>6. Exploded Views</b>	
6-1. Chassis (KV-13FS100/14FV300 Only) .....	39
6-2. Chassis (KV-13FS110 Only) .....	40
<b>7. Electrical Parts List</b> .....	41

## SPECIFICATIONS

	KV-13FS100/ 13FS110/ 14FV300(N)	KV-14FV300 (S)
<b>Power requirements</b>	120V, 60Hz	220V, 50/60Hz
<b>Number of Inputs/Outputs</b>		
Video <sup>1)</sup>	2	
Y, P <sub>B</sub> , P <sub>R</sub> <sup>2)</sup>	1	
Audio <sup>3)</sup>	3	
Speaker output (W)	3W x 2	
Headphones <sup>4)</sup>	1	
<b>Power Consumption (W)</b>		
In use (Max)	100W	
In Standby	1W	
<b>Dimensions(W/H/D)</b>		
mm	407 x 340 x 411 mm	
in	16 x 13 <sup>3/8</sup> x 16 <sup>1/8</sup>	
<b>Mass</b>		
kg	12 kg	
lbs	26 lbs. 7 oz.	

1) 1 Vp-p 75 ohms unbalanced, sync negative

2) Y: 1.0 Vp-p, 75 ohms, sync negative; PB: 0.7 Vp-p, 75 ohms; PR Vp-p, 75 ohms.

3) 500 mVrms (100% modulation), Impedance: 47 kilohms

4) More than 408 mVrms at the maximum volume setting (variable)  
More than 408 mVrms (fix); Impedance (output): 2 kilohms

**Television system**

American TV Standard, NTSC

**Visible screen size**

13 inch picture measured diagonally

**Antenna**

75 ohm external terminal for VHF/UHF

**Channel coverage**

VHF: 2-13/ UHF: 14-69/ CATV: 1-125

**Actual screen size**

14 inch measured diagonally

**Supplied Accessories**

Remote Commander:

RM-Y173

Size AA (R6) batteries (2)

**Picture tube**

FD Trinitron<sup>®</sup> tube

*Design and specifications are subject to change without notice.*



## WARNINGS AND CAUTIONS

### CAUTION

Short circuit the anode of the picture tube and the anode cap to the metal chassis, CRT shield, or carbon painted on the CRT, after removing the anode.

### WARNING!!

An isolation transformer should be used during any service to avoid possible shock hazard, because of live chassis. The chassis of this receiver is directly connected to the AC power line.



### SAFETY-RELATED COMPONENT WARNING!!

Components identified by shading and  mark on the schematic diagrams, exploded views, and in the parts list are critical for safe operation. Replace these components with Sony parts whose part numbers appear as shown in this manual or in supplements published by Sony. Circuit adjustments that are critical for safe operation are identified in this manual. Follow these procedures whenever critical components are replaced or improper operation is suspected.

---

### ATTENTION!!

Après avoir déconnecté le cap de l'anode, court-circuiter l'anode du tube cathodique et celui de l'anode du cap au châssis métallique de l'appareil, ou la couche de carbone peinte sur le tube cathodique ou au blindage du tube cathodique.

Afin d'éviter tout risque d'électrocution provenant d'un châssis sous tension, un transformateur d'isolement doit être utilisé lors de tout dépannage. Le châssis de ce récepteur est directement raccordé à l'alimentation du secteur.



### ATTENTION AUX COMPOSANTS RELATIFS A LA SECURITE!!

Les composants identifiés par une trame et par une marque  sur les schémas de principe, les vues explosées et les listes de pièces sont d'une importance critique pour la sécurité du fonctionnement. Ne les remplacer que par des composants Sony dont le numéro de pièce est indiqué dans le présent manuel ou dans des suppléments publiés par Sony. Les réglages de circuit dont l'importance est critique pour la sécurité du fonctionnement sont identifiés dans le présent manuel. Suivre ces procédures lors de chaque remplacement de composants critiques, ou lorsqu'un mauvais fonctionnement suspecte.

## SAFETY CHECK-OUT

After correcting the original service problem, perform the following safety checks before releasing the set to the customer:

1. Check the area of your repair for unsoldered or poorly soldered connections. Check the entire board surface for solder splashes and bridges.
2. Check the interboard wiring to ensure that no wires are "pinched" or touching high-wattage resistors.
3. Check that all control knobs, shields, covers, ground straps, and mounting hardware have been replaced. Be absolutely certain that you have replaced all the insulators.
4. Look for unauthorized replacement parts, particularly transistors, that were installed during a previous repair. Point them out to the customer and recommend their replacement.
5. Look for parts which, though functioning, show obvious signs of deterioration. Point them out to the customer and recommend their replacement.
6. Check the line cords for cracks and abrasion. Recommend the replacement of any such line cord to the customer.
7. Check the B+ and HV to see if they are specified values. Make sure your instruments are accurate; be suspicious of your HV meter if sets always have low HV.
8. Check the antenna terminals, metal trim, "metallized" knobs, screws, and all other exposed metal parts for AC leakage. Check leakage as described below.

### Leakage Test

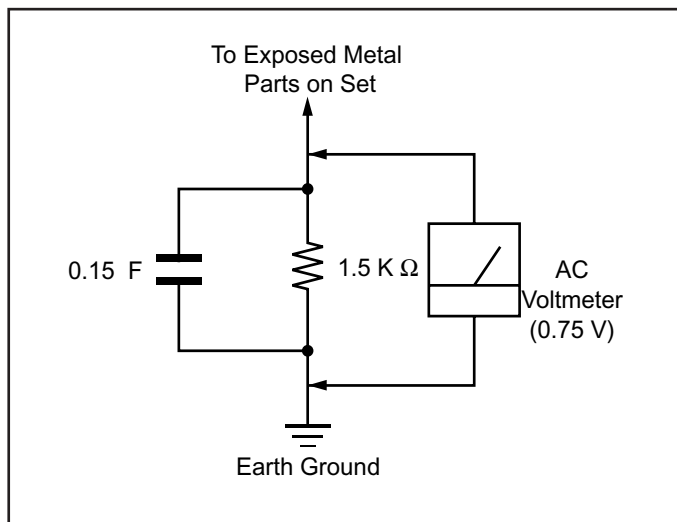

Figure A. Using an AC voltmeter to check AC leakage.

The AC leakage from any exposed metal part to earth ground and from all exposed metal parts to any exposed metal part having a return to chassis, must not exceed 0.5 mA (500 microamperes). Leakage current can be measured by any one of three methods.

1. A commercial leakage tester, such as the Simpson 229 or RCA WT-540A. Follow the manufacturers' instructions to use these instructions.
2. A battery-operated AC milliammeter. The Data Precision 245 digital multimeter is suitable for this job.
3. Measuring the voltage drop across a resistor by means of a VOM or battery-operated AC voltmeter. The "limit" indication is 0.75 V, so analog meters must have an accurate low voltage scale. The Simpson's 250 and Sanwa SH-63TRD are examples of passive VOMs that are suitable. Nearly all battery-operated digital multimeters that have a 2 VAC range are suitable (see Figure A).

### How to Find a Good Earth Ground

A cold-water pipe is a guaranteed earth ground; the cover-plate retaining screw on most AC outlet boxes is also at earth ground. If the retaining screw is to be used as your earth ground, verify that it is at ground by measuring the resistance between it and a cold-water pipe with an ohmmeter. The reading should be zero ohms.

If a cold-water pipe is not accessible, connect a 60- to 100-watt trouble-light (not a neon lamp) between the hot side of the receptacle and the retaining screw. Try both slots, if necessary, to locate the hot side on the line; the lamp should light at normal brilliance if the screw is at ground potential (see Figure B).

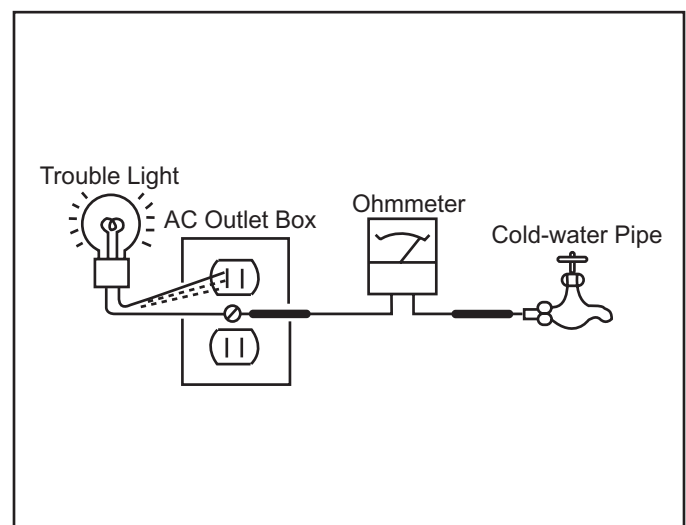

Figure B. Checking for earth ground.

## SELF-DIAGNOSTIC FUNCTION



The units in this manual contain a self-diagnostic function. If an error occurs, the STANDBY/TIMER LED will automatically begin to flash. The number of times the LED flashes translates to a probable source of the problem. A definition of the STANDBY/TIMER LED flash indicators is listed in the instruction manual for the user's knowledge and reference. If an error symptom cannot be reproduced, the Remote Commander can be used to review the failure occurrence data stored in memory to reveal past problems and how often these problems occur.

### Diagnostic Test Indicators

When an error occurs, the STANDBY/TIMER LED will flash a set number of times to indicate the possible cause of the problem. If there is more than one error, the LED will identify the first of the problem areas.

Results for all of the following diagnostic items are displayed on screen. No error has occurred if the screen displays a "0".

Diagnostic Item Description	No. of times STANDBY/ TIMER lamp flashes	Self-Diagnostic Display/ Diagnostic Result	Probable Cause Location	Detected Symptoms
Power does not turn on	Does not light	—————	<ul style="list-style-type: none"> <li>Power cord is not plugged in.</li> <li>Fuse is burned out (F601). (A Board)</li> </ul>	<ul style="list-style-type: none"> <li>Power does not come on.</li> <li>No power is supplied to the TV.</li> <li>AC Power supply is faulty.</li> </ul>
+B overcurrent (OCP)*	2 times	2:0 or 2:1	<ul style="list-style-type: none"> <li>H.OUT (Q506) is shorted. (A Board)</li> <li>IC1751 is shorted. (C Board)</li> </ul>	<ul style="list-style-type: none"> <li>Power does not come on.</li> <li>Load on power line is shorted.</li> </ul>
I-Prot	4 times	4:0 or 4:1	<ul style="list-style-type: none"> <li>+13V is not supplied. (A Board)</li> <li>IC545 is faulty. (A Board)</li> </ul>	<ul style="list-style-type: none"> <li>Has entered standby state after horizontal raster.</li> <li>Vertical deflection pulse is stopped.</li> <li>Power line is shorted or power supply is stopped.</li> </ul>
IK (AKB)	5 times	5:0 or 5:1	<ul style="list-style-type: none"> <li>Viedo OUT (IC545) is faulty. (A Board)</li> <li>IC001 is faulty. (A Board)</li> <li>Screen (G2) is improperly adjusted.**</li> </ul>	<ul style="list-style-type: none"> <li>No raster is generated.</li> <li>CRT Cathode current detection reference pulse output is small.</li> </ul>

\*If a +B overcurrent is detected, stoppage of the vertical deflection is detected simultaneously. The symptom that is diagnosed first by the microcontroller is displayed on the screen.

\*\*Refer to Screen (G2) Adjustments in Section 2-4 of this manual.

### Display of Standby/Timer LED Flash Count

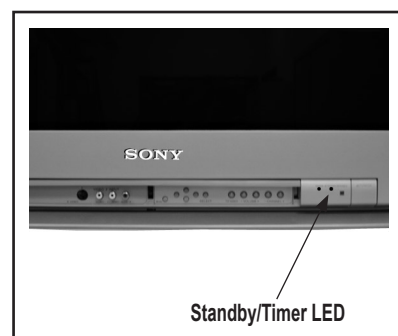
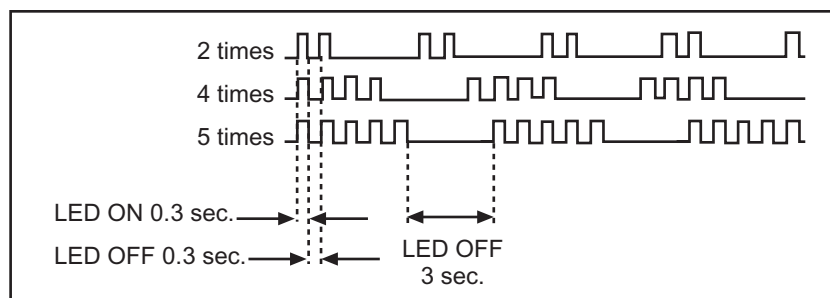

Diagnostic Item	Flash Count*
+B Overcurrent	2 times
I-Prot	4 times
IK (AKB)	5 times

\*One flash count is not used for self-diagnostic.

### Stopping the Standby/Timer LED Flash

Turn off the power switch on the TV main unit or unplug the power cord from the outlet to stop the STANDBY/TIMER LAMP from flashing.

### Self-Diagnostic Screen Display

For errors with symptoms such as "power sometimes shuts off" or "screen sometimes goes out" that cannot be confirmed, it is possible to bring up past occurrences of failure on the screen for confirmation.

#### To Bring Up Screen Test

In standby mode, press buttons on the Remote Commander sequentially, in rapid succession, as shown below:

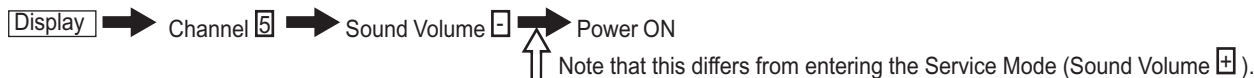

### Self-Diagnostic Screen Display

SELF DIAGNOSTIC
2: 000
3: N/A
4: 000
5: 001
101: N/A

Numeral "0" means that no fault was detected.  
Numeral "1" means a fault was detected one time only.

#### Handling of Self-Diagnostic Screen Display

Since the diagnostic results displayed on the screen are not automatically cleared, always check the self-diagnostic screen during repairs. When you have completed the repairs, clear the result display to "0".

Unless the result display is cleared to "0", the self-diagnostic function will not be able to detect subsequent faults after completion of the repairs.

#### Clearing the Result Display

To clear the result display to "0", press buttons on the Remote Commander sequentially when the diagnostic screen is displayed, as shown below:



#### Quitting the Self-Diagnostic Screen

To quit the entire self-diagnostic screen, turn off the power switch on the Remote Commander or the main unit.

### Self-Diagnostic Circuit

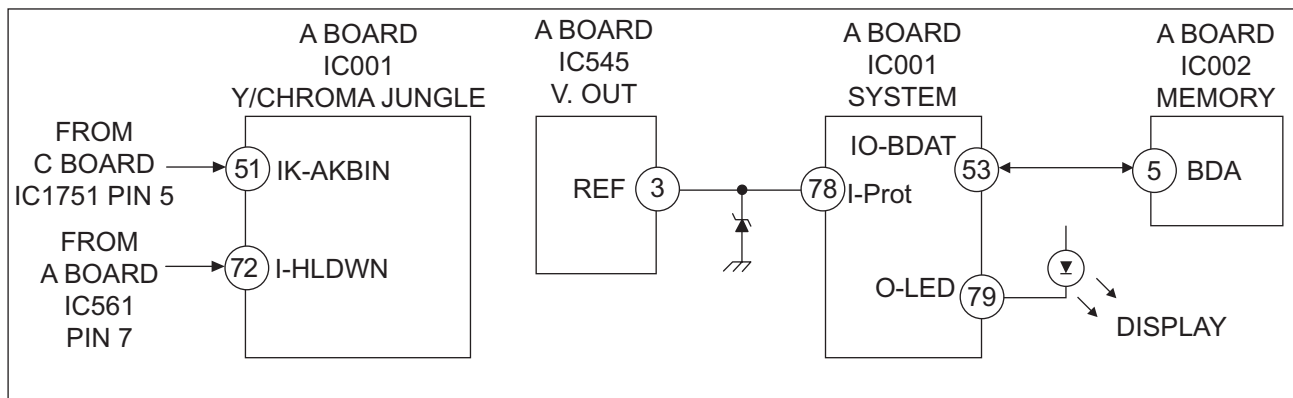

#### +B overcurrent (OCP)

Occurs when an overcurrent on the +B (135V) line is detected by pin 72 of IC001 (A Board). If the voltage of pin 72 of IC001 (A Board) is less than 1V when V.SYNC is more than seven verticals in a period, the unit will automatically turn off.

#### I-Prot

Occurs when an absence of the vertical deflection pulse is detected by pin 78 of IC001 (A Board). Power supply will shut down when waveform interval exceeds 2 seconds.

#### IK (AKB)

If the RGB levels\* do not balance within 2 seconds after the power is turned on, this error will be detected by IC001 (A Board). TV will stay on, but there will be no picture.

\* (Refers to the RGB levels of the AKB detection Ref pulse that detects 1K).

## SECTION 1: DISASSEMBLY

### 1-1. REAR COVER REMOVAL

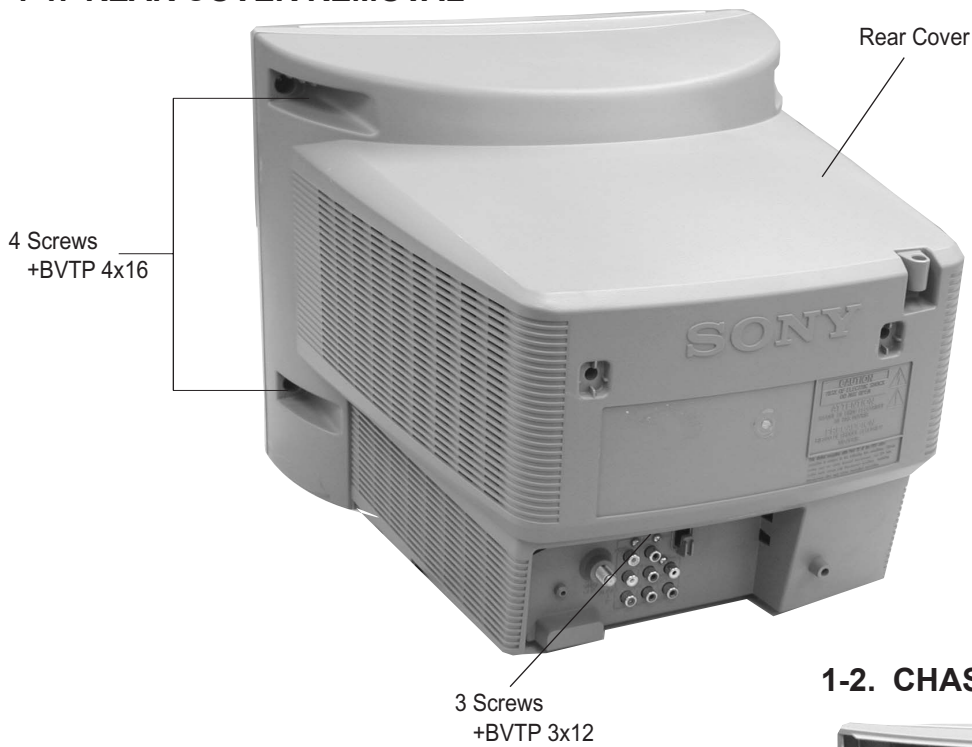

### 1-2. CHASSIS ASSEMBLY REMOVAL

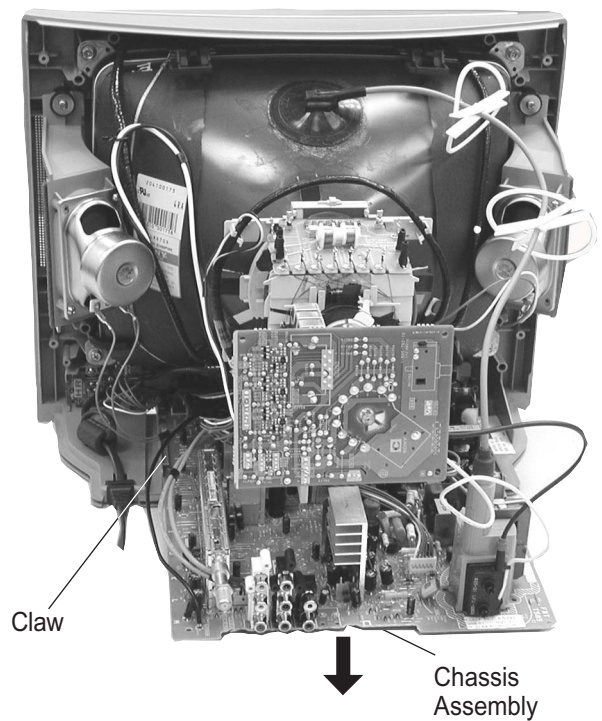

### 1-3. SERVICE POSITION

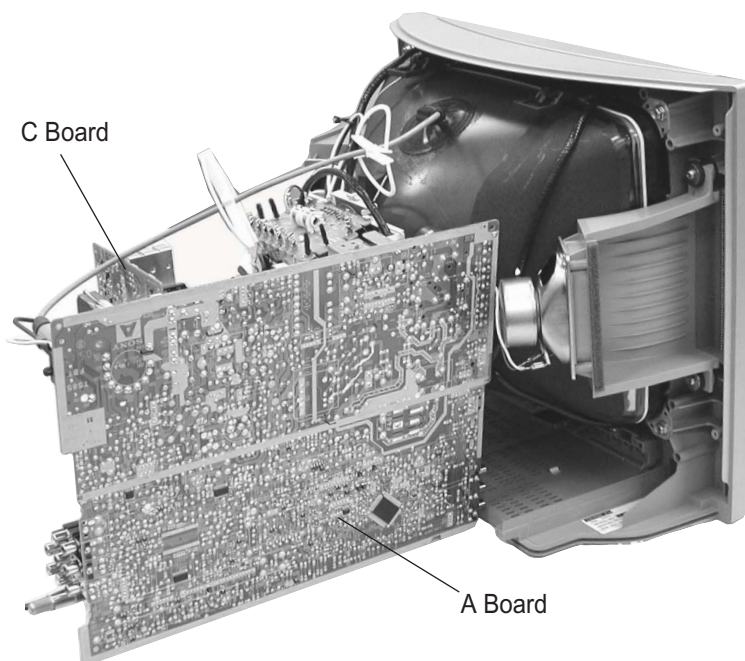

## 1-4. PICTURE TUBE REMOVAL

### WARNING: BEFORE REMOVING THE ANODE CAP

High voltage remains in the CRT even after the power is disconnected. To avoid electric shock, discharge CRT before attempting to remove the anode cap. Short between anode and CRT coated earth ground strap.

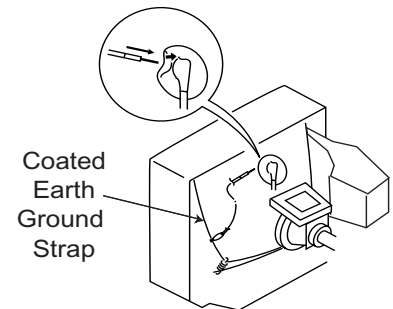
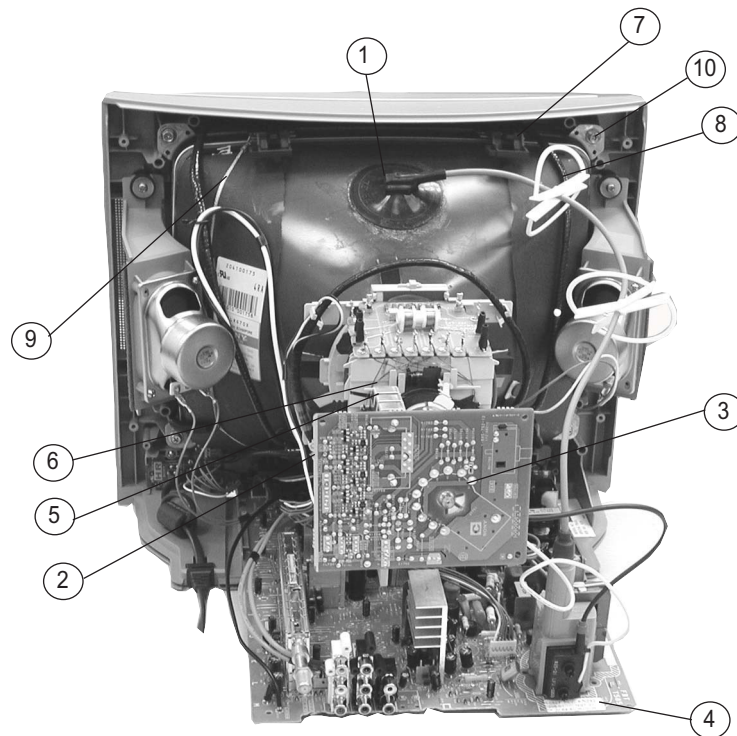

1. Discharge the anode of the CRT and remove the anode cap.
2. Unplug all interconnecting leads from the deflection yoke, neck assembly, degaussing coils and CRT grounding strap.
3. Remove the C Board from the CRT.
4. Remove the chassis assembly.
5. Loosen the neck assembly fixing screw and remove.
6. Loosen the deflection yoke fixing screw and remove.
7. Place the set with the CRT face down on a cushion and remove the degaussing coil holders.
8. Remove the degaussing coils.
9. Remove the CRT grounding strap and spring tension devices.
10. Unscrew the four CRT fixing screws [located on each CRT corner] and remove the CRT [Take care not to handle the CRT by the neck].

## ANODE CAP REMOVAL PROCEDURE

**WARNING:** High voltage remains in the CRT even after the power is disconnected. To avoid electric shock, discharge CRT **before** attempting to remove the anode cap. Short between anode and coated earth ground strap of CRT.

**NOTE:** After removing the anode cap, short circuit the anode of the picture tube and the anode cap to either the metal chassis, CRT shield, or carbon painted on the CRT.

### REMOVAL PROCEDURES

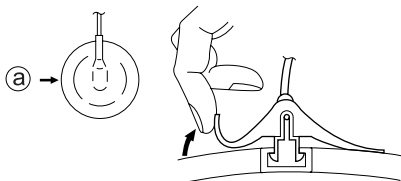

Turn up one side of the rubber cap in the direction indicated by arrow (a) .

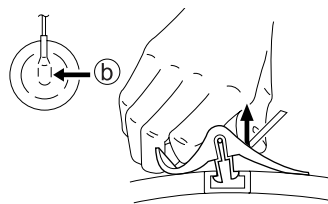

Use your thumb to pull the rubber cap firmly in the direction indicated by arrow (b) .

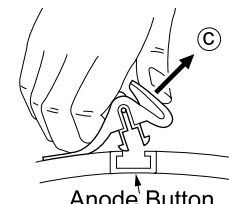

When one side of the rubber cap separates from the anode button, the anode cap can be removed by turning the rubber cap and pulling it in the direction of arrow (c) .

### HOW TO HANDLE AN ANODE CAP

1. Do not use sharp objects which may cause damage to the surface of the anode cap.
2. To avoid damaging the anode cap, do not squeeze the rubber covering too hard. A material fitting called a shatter-hook terminal is built into the rubber.
3. Do not force turn the foot of the rubber cover. This may cause the shatter-hook terminal to protrude and damage the rubber.

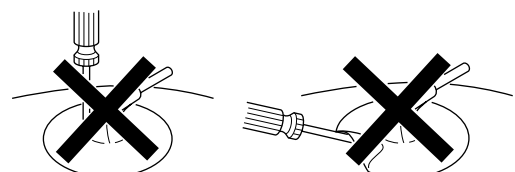



## SECTION 2: SET-UP ADJUSTMENTS

The following adjustments should be made when a complete realignment is required or a new picture tube is installed.

These adjustments should be performed with rated power supply voltage unless otherwise noted.

Set the controls as follows unless otherwise noted:

VIDEO MODE: Standard

PICTURE CONTROL: Normal

BRIGHTNESS CONTROL: Normal

Perform the adjustments in order as follows:

1. Beam Landing
2. Convergence
3. Focus
4. Screen (G2)
5. White Balance

**Note Test Equipment Required:**

1. Color Bar Pattern Generator
2. Degausser
3. DC Power Supply
4. Digital Multimeter

### 2-1. BEAM LANDING

Before beginning adjustment procedure:

1. Degauss the entire screen.
2. Feed in the white pattern signal.

#### 2-1-1. ADJUSTMENT PROCEDURE

1. Input a raster signal with the pattern generator.
2. Loosen the deflection yoke mounting screw, and set the purity control to the center as shown below:

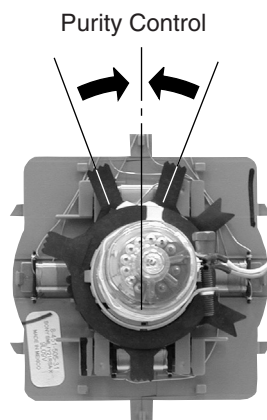

3. Turn the raster signal of the pattern generator to green.
4. Move the deflection yoke backward, and adjust with the purity control so that green is in the center and red and blue are even on both sides.

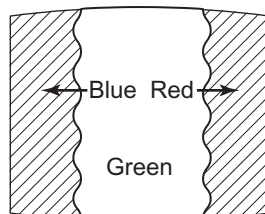

5. Move the deflection yoke forward, and adjust so that the entire screen becomes green.

6. Switch over the raster signal to red and blue and confirm the condition.
7. When the position of the deflection yoke is determined, tighten it with the deflection yoke mounting screw.
8. If landing at the corner is not right, adjust by using the disk magnets.

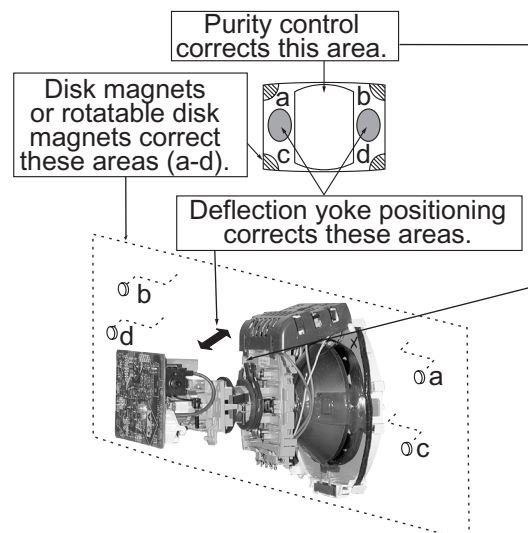
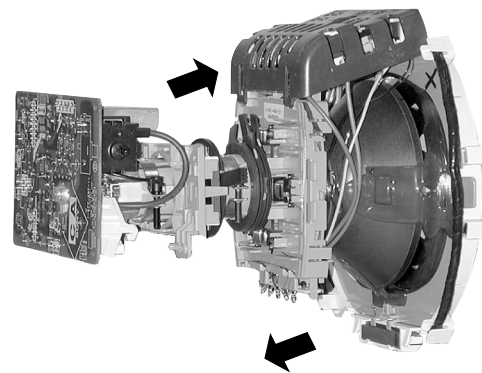

## 2-2. CONVERGENCE

Before starting convergence adjustments:

- 1 Perform FOCUS, VLIN and VSIZE adjustments.
2. Set BRIGHTNESS control to minimum.
3. Feed in dot pattern.

### 2-2-1. VERTICAL STATIC CONVERGENCE

1. Adjust V. STAT magnet to converge red, green and blue dots in the center of the screen (Vertical movement adjust S V.STAT RV1750 to converge).

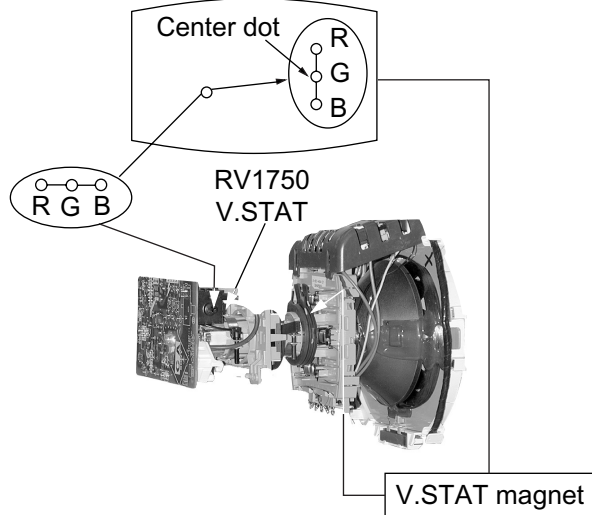

2. Tilt the V. STAT magnet and adjust static convergence to open or close the V. STAT magnet.

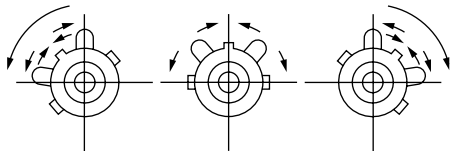

When the V. STAT magnet is moved in the direction of arrow a and b, red, green, and blue dots move as shown below:

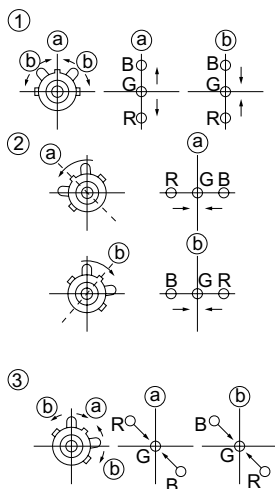

### 2-2-2. HORIZONTAL STATIC CONVERGENCE

If the blue dot does not converge with the red and green dots, perform the following:

1. Move BMC magnet (a) to correct insufficient H.Static convergence.
2. Rotate BMC magnet (b) to correct insufficient V.Static convergence.
3. After adjusting the BMC magnet, repeat Beam Landing Adjustment.

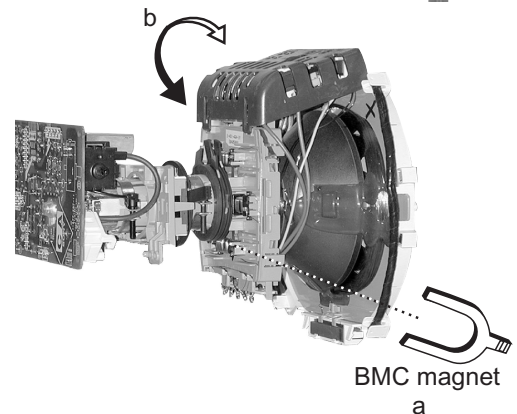
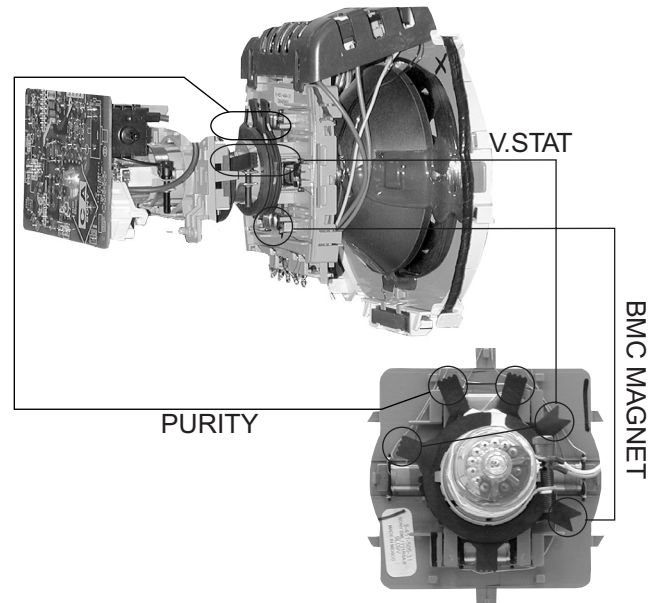



### 2-2-3. DYNAMIC CONVERGENCE ADJUSTMENT

Before performing this adjustment, perform Horizontal and Vertical Static Convergence Adjustment.

1. Slightly loosen deflection yoke screw.
2. Remove deflection yoke spacers.
3. Move the deflection yoke for best convergence as shown below:

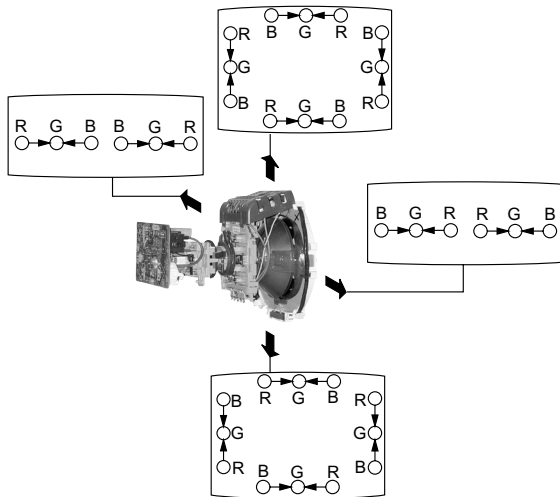

4. Tighten the deflection yoke screw.
5. Install the deflection yoke spacers.

### 2-2-4. TLH PLATE ADJUSTMENT

1. Input crosshatch pattern.
2. Adjust PICTURE QUALITY to standard, PICTURE and BRIGHTNESS to 50%, and OTHER to standard.
3. Adjust the Horizontal Convergence of red and blue dots by tilting the TLH plate on the deflection yoke.

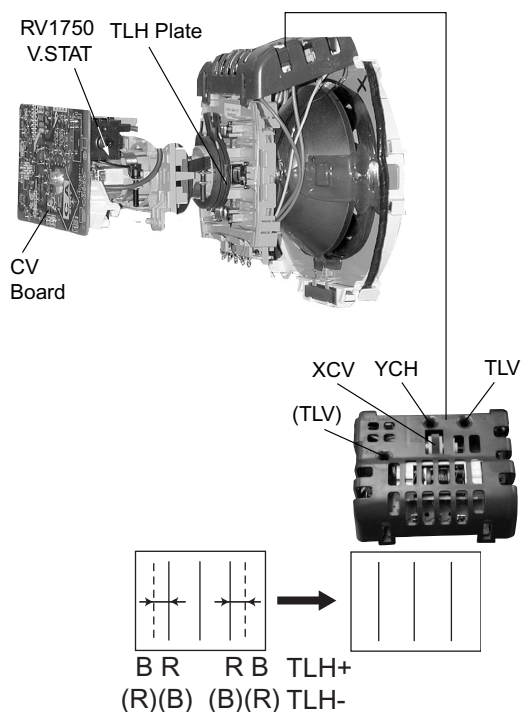

4. Adjust XCV core to balance X axis.
5. Adjust YCH VR to balance Y axis.
6. Adjust vertical red and blue convergence with V.TILT (TLV VR.)  
Note: Perform adjustment 3-6 while tracking items 1 and 2.

### 2-2-5. SCREEN-CORNER CONVERGENCE

1. Affix a permalloy assembly corresponding to the misconverged areas:

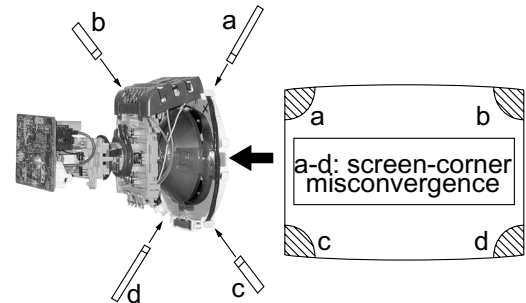

### 2-3. FOCUS

1. Adjust FOCUS control for best pictures.

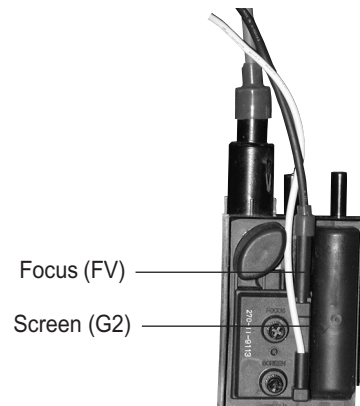

### 2-4. SCREEN (G2)

1. Input a dot pattern.
2. Set the PICTURE and BRIGHTNESS controls at minimum and COLOR control at normal.
3. Adjust SBRT, GCUT, BCUT in service mode with an oscilloscope as shown below so that voltages on the red, green, and blue cathodes are  $160 \pm 2\text{VDC}$ .

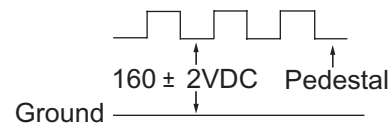

## 2-5. METHOD OF SETTING THE SERVICE ADJUSTMENT MODE

### 2-5-1. SERVICE MODE PROCEDURE

- Standby mode (power off).
- Press **[Display]** → Channel **[5]** → Sound Volume **[+]** → Power on the Remote Commander (press each button within a second).

### 2-5-2. SERVICE ADJUSTMENT MODE ON

- The CRT displays the time being adjusted.

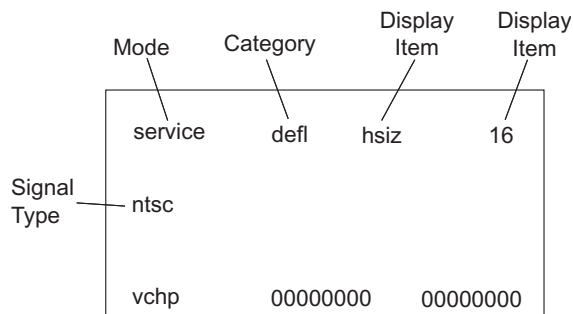

- Press **[1]** or **[4]** on the Remote Commander to select the time.
- Press **[3]** or **[6]** on the Remote Commander to change the data.
- Press **[MUTING]** then **[ENTER]** to save into the memory.

### 2-5-3. SERVICE ADJUSTMENT MODE MEMORY

Turn the set off then on to exit Service Adjustment Mode.

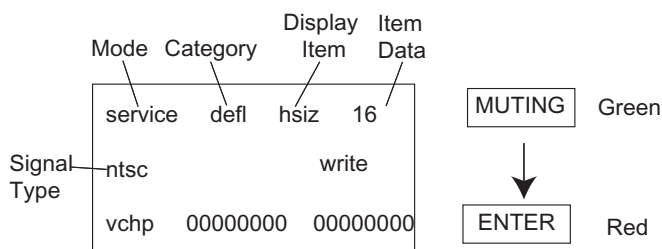



## 2-6. WHITE BALANCE ADJUSTMENTS

- Input an entire white signal with burst.
- Set to Service Adjustment Mode.
- Set the PICTURE and BRIGHTNESS to minimum.
- Adjust with SBRT if necessary.
- Select GCUT and BCUT with **[1]** and **[4]**.
- Adjust with **[3]** and **[6]** for the best white balance.
- Set the PICTURE and BRIGHTNESS to maximum.
- Select GDRV and BDRV with **[1]** and **[4]**.
- Adjust with **[3]** and **[6]** for the best white balance.
- To write into memory, press **[MUTING]** then **[ENTER]**.

## SECTION 3: SAFETY RELATED ADJUSTMENTS

### 3-1. R565 CONFIRMATION METHOD (HV HOLD-DOWN CONFIRMATION) AND READJUSTMENTS

The following adjustments should always be performed when replacing the following components which are marked with  on the schematic diagram:

Part Replaced (  )	Adjustment (  )
DY, T585, CRT, IC001, IC561, C507, C508, C506, L511, L510, C588, L588, C566, C561, C563, D567, D568, D566, R567, R568, R565, R566, R562, R563, R561, R528.....A Board	HV HOLD-DOWN R565

#### 3-1-1. PREPARATION BEFORE CONFIRMATION

- Using a Variac, apply AC input voltage: 120 +0, -0.3 VAC.
- Turn the POWER switch ON.
- Input a white signal and set the PICTURE and BRIGHTNESS controls to maximum.
- Confirm that the voltage between C566 (+) or TP30 and ground is more than 105 VDC.

#### 3-1-2. HOLD-DOWN OPERATION CONFIRMATION

- Connect the current meter between Pin 11 of the FBT (T585) and the PWB land where Pin 11 would normally attach (See Figure 1 on the next page).
- Input a dot signal and set PICTURE and BRIGHTNESS to minimum: IABL =  $100 \pm 100\mu\text{A}$ .
- Confirm the voltage of A Board TP-23 is  $135.6 \pm 1\text{VDC}$ .
- Connect the digital voltmeter and the DC power supply via Diode 1SS119 to C566 (+) and ground (See Figure 1 on next page).
- Increase the DC power voltage gradually until the picture blanks out.
- Turn DC power source off immediately.
- Read the digital voltmeter indication (standard < 120VDC).
- Input a white signal and set PICTURE and BRIGHTNESS to maximum: IABL =  $820 \pm 100\mu\text{A}$ .
- Repeat steps 4 to 7.

### 3-1-3. HOLD-DOWN READJUSTMENT

If the setting indicated in Step 2 of Hold-Down Operation Confirmation cannot be met, readjustment should be performed by altering the resistance value of R565 component marked with .

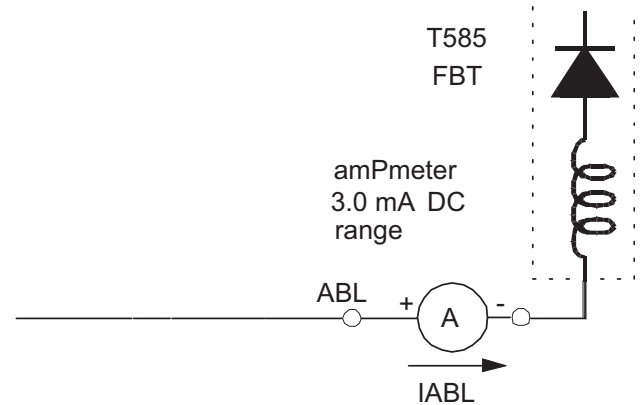

### 3-2. B+ VOLTAGE CONFIRMATION AND ADJUSTMENT

Note: The following adjustments should always be performed when replacing the following components, which are marked with  on the schematic diagram on the A Board:

<b>A BOARD:</b>	IC604, PH602
-----------------	--------------

- Using a Variac, apply AC input voltage: 130 + 2.0 / - 0.0 VAC.
- Input a DOT pattern at Q.C.
- Set the PICTURE and the BRIGHTNESS controls to minimum.
- Confirm the voltage of A Board between TP-23 & Ground is < 136.6 VDC.
- If step 4 is not satisfied, replace the components listed above, then repeat Steps 1–3.



## SECTION 4: CIRCUIT ADJUSTMENTS

### ELECTRICAL ADJUSTMENTS BY REMOTE COMMANDER

Use the Remote Commander (RM-Y173) to perform the circuit adjustments in this section.

**Test Equipment Required:** 1. Pattern generator 2. Frequency counter 3. Digital multimeter 4. Audio oscillator

#### 4-1. SETTING THE SERVICE ADJUSTMENT MODE

- Standby mode (Power off).
- Press the following buttons on the remote commander within a second of each other:

**Display** → **Channel 5** → **Sound Volume +** → **Power**

##### 4-1-1. SERVICE ADJUSTMENT MODE ON

- The CRT displays the item being adjusted.

	Mode	Category	Display Item	Item Data
	service	defl	hsiz	16
Signal Type	ntsc			
	vchp	00000000	00000000	

- Press **1** or **4** on the Remote Commander to select the item.
- Press **3** or **6** on the Remote Commander to change the data.
- Press **MUTING** then **ENTER** to write into memory.

##### 4-1-2. SERVICE ADJUSTMENT MODE MEMORY

	Mode	Category	Display Item	Item Data
	service	defl	hsiz	16
Signal Type	ntsc			write
	vchp	00000000	00000000	

**MUTING** Green

**ENTER** Red

- Press **0** then **ENTER** on the Remote Commander to initialize.

	Mode	Category	Display Item	Item Data
	service	defl	hsiz	16
Signal Type	ntsc			write
	vchp	00000000	00000000	

**MUTING** Green

**ENTER** Red

Carry out Step 1 when adjusting IDs 0-7 and when replacing and adjusting IC002

- Turn set off then on to exit Service Adjustment Mode.

#### 4-2. MEMORY WRITE CONFIRMATION METHOD

- After adjustment, pull out the plug from the AC outlet, then replace the plug in the AC outlet again.
- Turn the power switch ON and set to Service Mode.
- Call the adjusted items again to confirm they were adjusted.

#### 4-3. REMOTE ADJUSTMENT BUTTONS AND INDICATORS

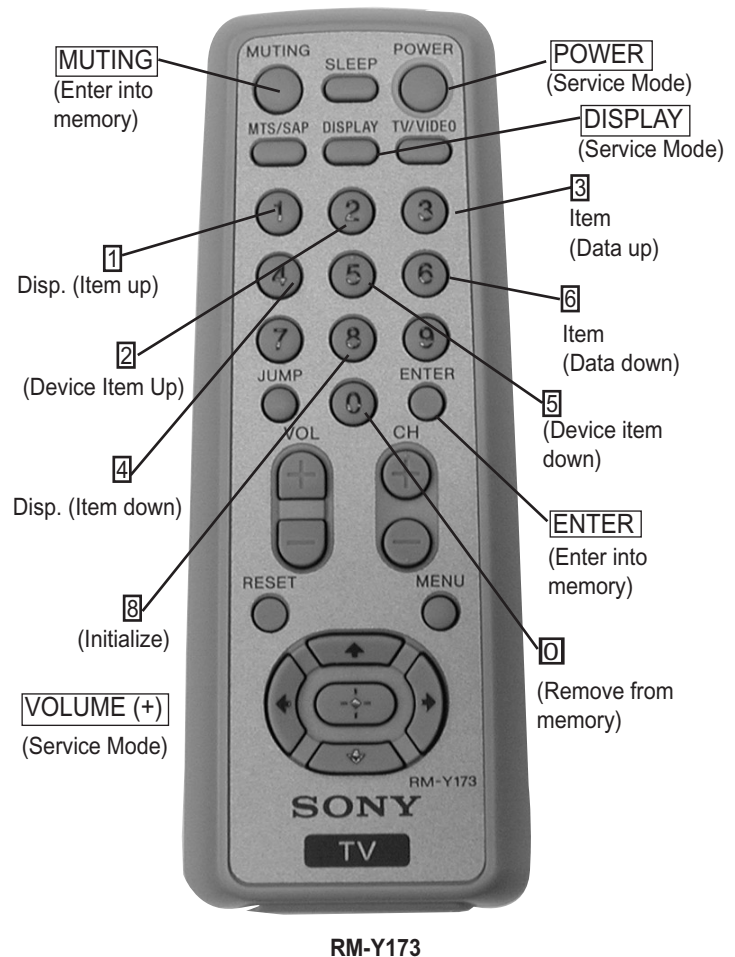

## 4-3-1. ADJUSTMENT ITEMS (1 OF 8)

## DEVICE "DEF"

Item#	OSD	DETAIL	Range (DEC)	Initial Data
1	HSIZ	H SIZE(EW DC)	00-63	24
2	HPOS	H POSITION	00-63	24
3	VSIZ	V RAMP SIZE	00-63	37
4	VPOS	V POSITION(RAMP DC)not useful	00-63	28
5	VLIN	V LINEARITY	00-63	42
6	SCOR	S CORRECTION	00-63	28
7	VBOW	BOW	00-63	33
8	VANG	ANGLE	00-63	35
9	TRAP	EW TRAPESIUM	00-63	34
10	PAMP	EW PIN	00-63	18
11	UPIN	UPPER PIN	00-63	32
12	LPIN	LOWER PIN	00-63	32
13	TROT	TROT	00-255	128
14	HBLK	H BLK mode select	00-01	0
15	LBLK	HBLK front timing	00-63	11
16	RBLK	HBLK rear timing	00-15	35
17	VBLK	V BLK width	00-03	0
18	HMSK	TOP VEND(when MACROVISION)prevent OFF	00-01	0
19	HDW	H PULSE WIDTH(25u/19u)	00-01	1
20	AFC	AFC GAIN	00-01	0
21	AFC1	AFC1 TIME CONSTANT	00-07	3
22	AFCW	AFC1 PULL IN WIDE	00-01	1
23	CDMD	V DET WINDOW SW TIMING	00-03	1
24	HSS	SYNC SLICE LEVEL(H sepa)	00-03	0
25	VSS	SYNC SLICE LEVEL(V sepa)	00-03	3
26	SLDN	Auto Slice level DOWN	00-03	0
27	SLUP	Auto Slicelevel UP	00-01	0
28	JPSW	Jump SW	00-01	0
29	HOSC	H VCO fo ADJUST	00-255	5
30	EHT	EHT	00-15	6
31	EHTG	EHT MODE	00-01	0

## DEVICE "16:9"

Item#	OSD	DETAIL	Range (DEC)	Initial Data
1	PAMP	EW PIN	00-63	59
2	UPIN	UPPER PIN	00-63	15
3	LPIN	LOWER PIN	00-63	21
4	ACLV	ACL VTH	00-03	0
5	ABLV	ABL VTH	63-00	58

## DEVICE "VP1"

Item#	OSD	DETAIL	Range (DEC)	Initial Data
1	RDRV	R DRIVE	00-127	40
2	GDRV	G DRIVE when Color Temp. is "Cool" and "Neutral"	00-127	18
3	BDRV	B DRIVE when Color Temp. is "Cool" and "Neutral"	00-127	27
4	RCUT		00-1023	300
5	GCUT		00-1023	225
6	BCUT		00-1023	182
7	SCON	CONTRAST LEVEL	00-127	11
8	SHUE	TINT	00-127	8
9	SCOL	COLOR LEVEL	00-127	13
10	SBRT	BRIGHT	00-255	36
11	RON	R OUTPUT MUTE	00-01	1
12	GON	G OUTPUT MUTE	00-01	1
13	BON	B OUTPUT MUTE	00-01	1
14	BLLV	BLUE STRETCH(00:no <-> 11:deep)	00-03	1
15	MTRX	MATRIX RATIO SELECT	00-03	2
16	AXIS	R-Y PHASE OFFSET	00-63	48
17	SSHO	SHARPNESS GAIN(OVER)	00-63	23
18	SSHP	SHARPNESS GAIN(PRE)	00-63	24
19	SHPF	SHRPNESS fo(00:2 CLK <-> 11:5 CLK)	00-03	1



**ADJUSTMENT ITEMS (2 OF 8)****DEVICE "VP1"**

Item#	OSD	DETAIL	Range (DEC)	Initial Data
20	SHCL	SHARPNESS CPRING LEVEL	00-15	0
21	SHMX	SHARPNESS LIMITER LEVEL	00-15	15
22	ACLV	ACL VTH	00-03	0
23	ABLV	ABL VTH	00-63	0
24	AKBD	AKB Self Diagnostic Counter(@1sec)	00-07	0
25	AKBS	AKB H/W S/W Switch	00-02	1
26	REFP	AKB REFPLS timing	00-01	1
27	YNRC	YNR LIMITER LEVEL	00-15	15
28	BKON	BLACK STRETCH ON	00-01	1
29	BKTH	BLACK STRETCH DETECTOR TRESH LEVEL	00-255	22
30	BKAR	BLACK STRETCH DETECTOR TRESH AREA	00-03	1
31	BKSP	BLACK STRETCH START POINT	00-03	3

**DEVICE "VP2"**

Item#	OSD	DETAIL	Range (DEC)	Initial Data
1	VMLO	VM LEVEL at "Low" Setting	00-15	10
2	VMHI	VM LEVEL at "High" Setting	00-15	15
3	VMDL	VM DELAY	00-15	6
4	VMPL	VM PORALITY	00-01	0
5	VMWD	VM WIDTH	00-03	0
6	VMCL	VM CORING LEVEL	00-15	0
7	VMMX	VM LIMITER LEVEL	00-15	15
8	CKLV	COLOR KILLER VTH	00-127	1/YUV:0
9	CKON	FORCE KILLER	00-01	0
10	ALFA	ADAPTIVE DET SENSITIVITY	00-03	2
11	YCMD	YC SEPA FORCE SELECT(00:ADAPTIVE 01:H 10:V 11:HV)	00-03	0
12	VACL	V APERTURE CORING LEVEL	00-15	0
13	VAGA	V APERTURE GAIN LEVEL	00-15	Soft Cont'l
14	VAMX	V APERTURE LIMITER LEVEL	00-15	3
15	GAMM	GANMA(00:no <-->11:deep)	00-03	Soft Cont'l
16	YDLY	Y DELAY TIME	00-03	3/YUV:3
17	CDLY	C DELAY	00-03	2/YUV:2
18	YOFF	Y OUTPUT MUTE	00-01	0
19	CBPF	C BPF fo HI	00-01	1/YUV:0
20	CLIM	C OUTPUT LIMITTER	00-15	15
21	YFSL	Y BAND WIDTH	00-03	0
22	CFSL	C BAND WIDTH	00-03	0
23	BGPP	BGP(for C DECODER)TIMING	00-31	8
24	NRCH	NOISE DET TIME CONSTANT	00-03	0
25	NRCL	NOISE DET TIME CONSTANT	00-255	8
26	NRVL	NOISE DET VTH	00-255	16
27	NRVH	NOISE DET VTH	00-255	0
28	GDOF	G DRIVE	00-31	18
29	BDOF	B DRIVE	00-31	31
30	GCOF	G CUTOFF	00-31	2
31	BCOF	B CUTOFF	00-31	0
32	DCTV	DCTTRANSFER VTH	00-127	5
33	DCTG	DCTTRANSFER GAIN	00-31	Soft Cont'l

**ADJUSTMENT ITEMS (3 OF 8)****DEVICE "VIVID"**

Item#	OSD	DETAIL	Range (DEC)	Initial Data
1	VPIC	Picture(VIVID)	00-63	63
2	VBRI	Brightness(VIVID)	00-63	31
3	VCOL	Color(VIVID)	00-63	31
4	VHUE	Hue(VIVID)	00-63	31
5	VSHA	Sharpness(VIVID)	00-63	31
6	VVM	VM(VIVID)	00-02	2
7	VTRI	Color Temp(VIVID)	00-02	0
8	VAPA	Aperture G(VIVID)	00-15	7
9	VGMA	Gamma(VIVID)	00-03	3
10	DCTG	DCT LV(VIVID)	00-03	16

**DEVICE "STD"**

Item#	OSD	DETAIL	Range (DEC)	Initial Data
1	VPIC	Picture(STANDARD)	00-63	63
2	VBRI	Brightness(STANDARD)	00-63	31
3	VCOL	Color(STANDARD)	00-63	31
4	VHUE	Hue(STANDARD)	00-63	31
5	VSHA	Sharpness(STANDARD)	00-63	31
6	VVM	VM(STANDARD)	00-02	2
7	VTRI	Color Temp(STANDARD)	00-02	0
8	VAPA	Aperture G(STANDARD)	00-15	7
9	VGMA	Gamma(STANDARD)	00-03	3
10	DCTG	DCT LV(STANDARD)	00-03	16

**DEVICE "MOVIE"**

Item#	OSD	DETAIL	Range (DEC)	Initial Data
1	VPIC	Picture(MOVIE)	00-63	31
2	VBRI	Brightness(MOVIE)	00-63	54
3	VCOL	Color(MOVIE)	00-63	25
4	VHUE	Hue(MOVIE)	00-63	31
5	VSHA	Sharpness(MOVIE)	00-63	31
6	VVM	VM(MOVIE)	00-02	0
7	VTRI	Color Temp(MOVIE)	00-02	2
8	VAPA	Aperture G(MOVIE)	00-15	7
9	VGMA	Gamma(MOVIE)	00-03	3
10	DCTG	DCT LV(MOVIE)	00-03	16

**DEVICE "SPORTS"**

Item#	OSD	DETAIL	Range (DEC)	Initial Data
1	VPIC	Picture(SPORTS)	00-63	63
2	VBRI	Brightness(SPORTS)	00-63	31
3	VCOL	Color(SPORTS)	00-63	34
4	VHUE	Hue(SPORTS)	00-63	31
5	VSHA	Sharpness(SPORTS)	00-63	31
6	VVM	VM(SPORTS)	00-02	2
7	VTRI	Color Temp(SPORTS)	00-02	0
8	VAPA	Aperture G(SPORTS)	00-15	7
9	VGMA	Gamma(SPORTS)	00-03	3
10	DCTG	DCT LV(SPORTS)	00-03	16



## ADJUSTMENT ITEMS (4 OF 8)

## DEVICE "Y"

Item#	OSD	DETAIL	Range (DEC)	Initial Data
1	COFI	0:4 Linedelaies 1:2 Linedelaies	00-01	0
2	YNRS	YNR ON	00-01	0
3	YTHR	Y SIGNAL GENERATE from 2DYCS	00-01	0
4	Y2D	Y SIGNAL GENERATE from 2DYCS	00-01	0
5	2DFX	C SIGNAL GENELATE from H/V BPF only	00-01	1
6	CLPS	Y CLAMP TIME CONSTANT	00-01	1
7	VLPF	Y_LPF(ANALOG) fo Ajust	00-03	3
8	CLPF	C_LPF(ANALOG) fo Ajust	00-03	3
9	BKHS	BLACK STRETCH HYSTERISYS	00-31	1
10	BPFB	YCS HBPF SELECT(BACK)	00-03	1
11	BPFF	YCS HBPF SELECT(FRONT)	00-01	1

## DEVICE "C"

Item#	OSD	DETAIL	Range (DEC)	Initial Data
1	FORG	CHROMA DECODER PHASE SELECT	00-03	0
2	FSEL	CHROMA DECODER CLK SELECT	00-01	0/YUV:0
3	ACTL	ANALOG ACC AMP MAX GAIN	00-03	3
4	A1FL	ANALOG ACC hysteresis	00-255	34
5	A1FH		00-01	0
6	A1ON	ANALOG ACC AMP ON LEVEL	00-127	12
7	MV	MACROVISION(BURST) DET TRESH	00-15	0
8	MV1S	MACROVISION(BURST) DET ON	00-01	1
9	MV2S	MACROVISION(BURST) DET POSITION	00-01	1
10	ACCS	ACC ON/OFF	00-01	0/YUV:1
11	KILS	KILLER DET SELECT	00-01	0/YUV:1
12	AASL	C DECODER TIME CONSTANT(32,16,8,1H)	00-03	3
13	BASL	ACC TIME CONSTANT	00-03	0
14	ATIM	ANALOG ACC HISTERISYS SELECT	00-03	0
15	VMSK	ACC V BLK OFF WIDTH	00-07	0
16	A3ON	ACC MAX GAIN	00-01	0
17	INTE	C DECODER INTRGRATOR ENABLE	00-01	0
18	SIN	C DECODER PHASE V ENABLE	00-01	0
19	CKVT	PLL STOP BURST LEVEL	00-03	1
20	XFFR	VCXO FORCE FREERUN	00-01	0/YUV:1
21	ACCV	C DECODER PHASE V ENABLE	00-01	1
22	BWSL	KILLER DET SELECT	00-01	1/YUV:1
23	BWDT	PLL KILLER VTH	00-03	0/YUV:3
24	A23E	AMP2,3 ON/OFF ENABLE(0 FIX)	00-01	1
25	A2ON	ABL VTH	00-127	12
26	A3ON	ACL VTH	00-127	12
27	A2FL	AMP2 OFF LEVEL lower	00-255	34
28	A2FH	AMP2 OFF LEVEL upper	00-01	0
29	A3FL	AMP3 OFF LEVEL lower	00-255	34
30	A3FH	AMP3 OFF LEVEL upper	00-01	0
31	AXTH	AXS HYS	00-63	30
32	ACTH	ROM HYS	00-63	10
33	AVAV	AVE SEL AV	00-03	3
34	B2TH	B2COMP	00-127	0

## ADJUSTMENT ITEMS (5 OF 8)

## DEVICE "RGB"

Item#	OSD	DETAIL	Range (DEC)	Initial Data
1	AMUT	RGB POWER ON MUTE	00-01	0
2	PMUT	RGB MUTE(EXCEPT OSD)	00-01	1
3	VBLK		00-01	0
4	CORL	R CUTOFF lower	00-255	200
5	CORH	R CUTOFF upper	00-01	0
6	COGL	G CUTOFF lower when Color Temp. is "Cool" and "Neutral"	00-255	200
7	COGH	G CUTOFF upper when Color Temp. is "Cool" and "Neutral"	00-01	0
8	COBL	B CUTOFF lower when Color Temp. is "Cool" and "Neutral"	00-255	200
9	COBH	B CUTOFF upper when Color Temp. is "Cool" and "Neutral"	00-01	0
10	ABLS	ABL SELECT (ON:00, OFF:01)	00-01	0
11	ACLS	ACL ON (ON:00, OFF:01)	00-01	1
12	ALSP	ACL SPEED	00-03	1
13	ALRS	ACL RECOVER SPEED	00-15	2
14	ALAS	ACL ATTACK SPEED	00-15	9
15	ABLG	ABL GAIN	00-15	6
16	ALS2	ACL ATTACK SPEED(2)	00-03	2
17	AKBS	AKB MODE	00-01	1
18	AKBP	AKB PULSE HEIGHT	00-63	55
19	OSDL	OSD LIMMIT SELECT	00-01	0
20	MPXS	UV MULTIPLEX ON	00-01	0/YUV:0
21	CXUV	YC/YUV SELECT	00-01	0/YUV:1
22	UVIN	U/V INVERT	00-01	0/YUV:0
23	UVOS	UV OFFSET CANCELER ON	00-01	0/YUV:0
24	ACL	SOFT ACL CONTROLE	00-63	63
25	HBLK	H BLK OFF	00-01	0
26	VENS	V-latch OFF	00-01	0
27	UOFS	U IN OFFSET	00-15	8
28	VOFS	V IN OFFSET	00-15	5
29	AABL	ANALOG ABL THRESHOLD LEVEL CONTROL	00-15	0
30	AABG	ANALOG ABL GAIN CONTROL	00-01	0
31	AALG	ANALOG ACL GAIN CONTROL	00-01	0
32	AABS	ANALOG ABL ON/OFF CONTROL (ON:01, OFF:00)	00-01	0
33	AALS	ANALOG ACL ON/OFF CONTROL (ON:01, OFF:00)	00-01	1

## ADJUSTMENT ITEMS (6 OF 8)

## DEVICE "DEFD"

Item#	OSD	DETAIL	Range (DEC)	Initial Data
1	VSTP	V OUTPUT STOP	00-01	0
2	HFFR	AFC1 FORCE FREERUN	00-01	0
3	HFUP	H FREERUN FREQUENCY UP(700Hz)	00-01	0
4	VPHA	V PHASE(V POSITION ADJUST)	00-15	0
5	JSWW	Jump Pulse Width	00-01	0
6	EWG	EWV AD OUTPUT LEVEL(6db)	00-01	0
7	EWCL	EW/VRAMP DA CLOCK SELECT	00-03	2/YUV:2
8	EWDI	EW/VRAMP DA DITHER	00-01	0
9	XF0A	VCXO FREERUN ADJUST	00-15	0
10	BGST	BGP(for PLL) TIMING	00-63	17
11	SKWI	Skew correcter refernce phase	00-01	0/YUV:0
12	XPHA	VCXO PHASE ADJUST	00-15	10
13	SKEW	Skew correcterphase controle	00-07	0/YUV:3
14	HRMP	AFC2 TIME CONSTANT	00-03	0
15	RPLU	REF PLL TIME CONSTANT	00-07	3
16	RPLB	REF PLL TIME CONSTANT	00-01	1
17	XF0B	VCXO Fo ADJUST	00-03	0
18	RPLS	REF VCO FB LOOP SELECT	00-01	0
19	SSM	SyncSepaMasking CONTROL	00-01	0
20	VSAG	V-SAG prevent ON	00-01	0
21	AFC2	AFC2 GAIN CONTROL	00-03	0
22	VRFL	V RAMP FILTER SWITCHING OFF	00-01	0
23	SSLP	LPF pre SYNC SEPA ON/OFF	00-01	0
24	IMTS	I.M. TEST	00-01	0
25	XPLU	ACP TIME CONSTANT	00-01	1
26	8FSC	8fscCLK Skew OFF	00-01	1/YUV:1
27	4FS2	4fscCLK Skew OFF	00-01	1/YUV:1
28	EWVR	DSDAC V RESET Enable	00-01	0
29	VLOF	IIC V Latch OFF(for TEST)	00-01	0
30	1WIN	FORCE 1Window	00-01	1
31	BGPC	ANGLE Return current up	00-01	0
32	MHDL	ANGLE Return current up timing	00-01	1
33	BFRE	force V FREERUN	00-01	0
34	ANGG	ANGLE Retun current up	00-01	1
35	ANGT	ANGLE Retun current up timing	00-01	0
36	DOSD	Digital OSD ON	00-01	0
37	ANGS	AFC2 ANGLE/BOW INHIBIT	00-01	0
38	HRPP	FRAMP RRAMP H OUT CONTROL RANGE	00-15	8
39	VF50	FORCE V FREERUN 50Hz	00-01	0
40	CLKS	TBC clock system select	00-03	0
41	VBHK	V BLK HALF KILL	00-01	0
42	DSYC	CVBS INPUT CONTROL	00-01	0
43	VPW	V Pulse Wide	00-01	1
44	QSW	MODULATOR FEEDBACK GAIN CONTROL	00-01	0
45	ADTY	CLOCK DUTY CONTROL at IIC QSWITCH=ON	00-01	0
46	DTH	DITHER THRESHOLD LEVEL CONTROL at IIC AUTOD=ON	00-03	1
47	HBSW	HBLK REFERENCE AFC1/AFC2	00-01	0
48	DSCS	ΣDAC CLOCK ON/OFF CONTROL	00-01	0

## ADJUSTMENT ITEMS (7 OF 8)

## DEVICE "OTHER"

Item#	OSD	DETAIL	Range (DEC)	Initial Data
1	PCLP	SYNC TIP/PEDESTAL CLAMP SELECT	00-01	0
2	VRT	ADC REFERENCE (00:1.15Vpp 01:1.25Vpp 10:1.35Vpp 11:1.45Vpp)	00-03	1/YUV:1
3	AM	INTERIGENT MONITOR OUTPUT SELECT(analog)	00-15	0
4	DME	INTERIGENT MONITOR OUTPUT SELECT(degital)	00-01	0
5	DM	INTERIGENT MONITOR OUTPUT SELECT(degital)	00-31	0
6	14HI	4fsc(Skew)CLK POLARITY	00-01	0
7	14HD	4fscCLK(Skew)CLK DELAY ADJUST	00-03	1
8	28I	8fscCLK POLARITY	00-01	1
9	28D	8fscCLK DELAY ADJUST	00-03	1
10	ADCD	ADC CLK DELAY ADJUST	00-03	1/YUV:0
11	CLKS	AD/LOGIC CLK SWAP	00-01	0/YUV:0
12	HDSL	HD OUT(for MCU)SELECT	00-01	1
13	CPSL	PLL CP LATCH ON	00-01	0
14	CPCL	PLL CP LATCH CLOCK	00-01	0
15	CPCP	PLL CP LATCH POLARTY	00-01	0
16	DUMY	DUMMY	00-0F	1

## DEVICE "OSD"

Item#	OSD	DETAIL	Range (DEC)	Initial Data
1	HT	HALF TONE LEVEL	00-03	0
2	OSLR	R OSD LEVEL	00-63	27
3	OSLG	G OSD LEVEL	00-63	27
4	OSDC		00-03	0
5	OSDB	B OSD LEVEL	00-63	27

## DEVICE "S/W ADKB"

Item#	OSD	DETAIL	Range (DEC)	Initial Data
1	SRIL	S/W AKB RED OUTPUT Lower	00-255	Soft Cont'l
2	SRIH	S/W AKB RED OUTPUT Upper	00-01	Soft Cont'l
3	SGIL	S/W AKB GREEN OUTPUT Lower	00-255	Soft Cont'l
4	SGIH	S/W AKB GREEN OUTPUT Upper	00-01	Soft Cont'l
5	SBIL	S/W AKB BLUE OUTPUT Lower	00-255	Soft Cont'l
6	SBIH	S/W AKB BLUE OUTPUT Upper	00-01	Soft Cont'l
7	SLM1	S/W AKB LIMIT DATA 1	00-255	4
8	SLM2	S/W AKB LIMIT DATA 2	00-255	29
9	SLM3	S/W AKB LIMIT DATA 3	00-255	130
10	SAD1	S/W AKB ADD DATA 1	00-255	1
11	SAD2	S/W AKB ADD DATA 2	00-255	1
12	SBIT	S/W AKB BIT SHIFT DATA	00-05	0
13	SNOP	S/W AKB POWER ON NOP TIMER COUNTER DATA	00-FF	1
14	SERL	S/W AKB BIT ERROR JUDGE LEVEL	01-80	124
15	SPWC	S/W AKB ERROR JUDGE COUNTER DATA	01-FF	2
16	SLMC	S/W AKB LIM2/LIM3 JUDGE COUNTER DATA	01-FF	10
17	SPWL	S/W AKB POWER ON MUTE OFF JUDGE LEVEL	01-80	30
18	SPMT	S/W AKB POWER ON MUTE EXIT TIMER DATA(@100ms)	00-FF	120
19	SEEP	S/W AKB INITIAL DATA EEPROM WRITE TIMER(@1sec)	00-FF	20

## ADJUSTMENT ITEMS (8 OF 8)

## DEVICE "AUDIO PROCESSOR"

Item#	OSD	DETAIL	Range (DEC)	Initial Data
1	SBAL	Sub Balance	00-07	4
2	SBAS	Sub Bass	00-07	0
3	STRE	Sub Treble	00-07	0
4	SRL	Surround Level	00-01	0
5	BBOL	Surround Off-BBE Low	00-15	0
6	BBOH	Surround Off-BBE High	00-15	3
7	BBSL	Simulate BBE Low	00-15	0
8	BBSH	Simulate BBE High	00-15	0
9	BBGL	WOW Game BBE Low	00-15	7
10	BBGH	WOW Game BBE High	00-15	3
11	BBTL	SRS BBE Low	00-15	0
12	BBTH	SRS BBE High	00-15	2
13	VFIX	Audio output fix data	00-255	240
14	AGCL	AGC level	00-03	2

## DEVICE "MICROPROCESSOR"

Item#	OSD	DETAIL	Range (DEC)	Initial Data
1	DISP	OSD horizontal offset	00-127	62
2	CCHP	Closed Caption Horizontal Position	00-7E	82
3	HRLW	Low limit of H-pulse counting window (RF)	00-255	16
4	HRHG	High limit of H-pulse counting window (RF)	00-255	64
5	HSLW	Low limit of H-pulse counting window (S-Video)	00-255	16
6	HSHG	High limit of H-pulse counting window (S-Video)	00-255	64
7	HSDT	H-pulse Detection(S-Video)	00-255	8

## DEVICE "FEATURE"

Item#	OSD	DETAIL	Range (DEC)	Initial Data
	ID0	Language related	00-255	SEE ID MAP
	ID1	Video related	00-255	SEE ID MAP
	ID2	Audio related	00-255	SEE ID MAP
	ID3	Miscellaneous	00-255	SEE ID MAP
	ID4	Miscellaneous	00-255	SEE ID MAP
	ID5	Miscellaneous	00-255	SEE ID MAP
	ID6	Miscellaneous	00-255	SEE ID MAP
	ID7	Miscellaneous	00-255	SEE ID MAP

## Notes:

Range (DEC) shows the range of possible setting for each Adjustment Mode.

Initial Data shows the standard settings for each Adjustment Mode.

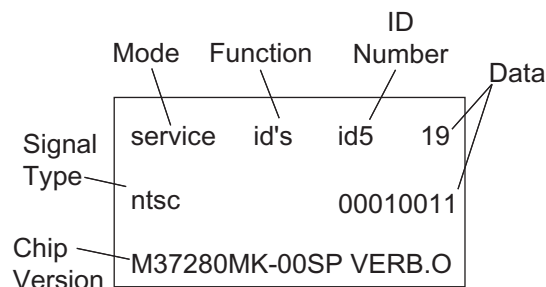

## 4-4. ID MAP TABLE

Model	Destination	ID-O	ID-1	ID-2	ID-3	ID-4	ID-5	ID-6	ID-7
KV-13FS100	US	89	7	65	33	128	32	0	150
KV-13FS100	CND	89	7	65	49	128	32	0	150
KV-13FS110	US	89	7	65	33	128	32	0	150
KV-13FS110	CND	89	7	65	49	128	32	0	150
KV-14FV300	E	81	7	65	129	160	32	0	214

## 4-5. A BOARD ADJUSTMENTS

### 4-5-1. H. FREQUENCY (FREE RUN) CHECK

1. Input a TV mode (RF) with no signal.
2. Connect a frequency counter to base of Q502 (TP-25 H. DRIVE) on the A Board.
3. Check H. Frequency for  $15735 \pm 200$  Hz for NTSC,  $15650 \pm 200$  Hz for PAL M and PAL N.

### 4-5-2. V. FREQUENCY (FREE RUN) CHECK

1. Select video 1 with no signal input.
2. Set the conditions for a standard setting.
3. Connect the frequency counter to TP-27 (V OUT) or CN515 pin ⑥ (V DY+) and ground on the A Board .
4. Check that V. Frequency shows  $60 \pm 4$  Hz for NTSC and PAL M,  $50 \pm 4$  Hz for PAL N.

### 4-5-3. DRIVE (SCON)

1. Input a color-bar signal and set the level to 75%.
2. Set in Standard mode.
3. Activate the Service Adjustment Mode.
4. Set AALS, ABLs, GON and BON items. Using **[3]** and **[6]** set each to the following values. Leave RON set to "1".

Signal Type	Mode	Category	Display Item	Item Data
ntsc	service	video	rdrv	26
vchp				00000000 00000000

AALS: OFF (0)  
 ABLs: OFF (1)  
 R ON: ON (1)  
 G ON: OFF (0)  
 B ON: OFF (0)

5. Connect an oscilloscope probe to CV Board, J1751Pin 12 (KR) (Red Out) .
6. Select SCON with **[1]** and **[4]** .
7. Adjust the value of SCON with **[3]** and **[6]** for  $78.5 \pm 2V_{pp}$ .

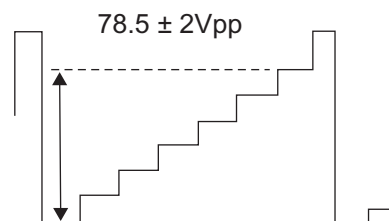

8. Reset AALS, ABLs, GON and BON values to "1".  
 AALS: ON (1)  
 ABLs: ON (0)  
 R ON: ON (1)  
 G ON: ON (1)  
 B ON: ON (1)
9. Press **[MUTING]** then **[ENTER]** to save into the memory.

### 4-5-4. DISPLAY POSITION ADJUSTMENT (DISP)

1. Input a color-bar signal.
2. Set to Service Adjustment Mode.
3. Select DISP with **[1]** and **[4]** .
4. Adjust values of DISP with **[3]** and **[6]** to adjust characters to the center.
5. Write to memory by pressing **[MUTING]** then **[ENTER]** .
6. Check to see if the text is displayed on the screen.

Signal Type	Mode	Category	Display Item	Item Data
ntsc	service	micro	disp	48
vchp				00000000 00000000

### 4-5-5. SUB BRIGHT ADJUSTMENT (SBRT)

1. Input a monoscope signal.
2. Activate the Service Adjustment Mode.
3. Set the PICTURE and BRIGHTNESS to minimum.
4. Select the SBRT item with **[1]** and **[4]** .
5. Adjust the values of SBRT with **[3]** and **[6]** to obtain a faintly visible crosshatch.
6. Press **[MUTING]** then **[ENTER]** to save into the memory.

### 4-5-6. SUB HUE, SUB COLOR ADJUSTMENT (SHUE, SCOL)

1. Input color-bar signal at 75%.
2. Activate the Service Adjustment Mode.
3. Set (PIC) to Max and (COL) to 50%.
4. Connect an oscilloscope probe to CV Board, CN301Pin ④ Blue Out.
5. Select the SHUE and SCOL item with **[1]** and **[4]** .

- While showing the SHUE item, adjust the waveform with **1** and **4** until the second and third bars show the same level ( $V2 = V3 < 0.15V_{p-p}$ ). Set Sub Hue -2 Step.
- While showing the SCOL item, adjust the waveform with **3** and **6** until the first and fourth bars show the same level ( $V1 = V4 < 0.15V_{p-p}$ ).

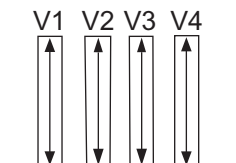

- Press **MUTING** then **ENTER** to save into the memory.

#### 4-5-7. V. SIZE ADJUSTMENT (VSIZ)

- Input a crosshatch signal.
- Activate the Service Adjustment Mode.
- Select the VSIZ item with **1** and **4**.
- Adjust value of VPOS with **1** and **4** for the best vertical center.
- Press **MUTING** then **ENTER** to save into the memory.

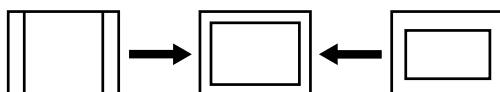

#### 4-5-8. V. CENTER ADJUSTMENT (VPOS)

Perform this adjustment after performing H. Frequency (Free Run) Check.

- Input a crosshatch signal.
- Activate the Service Adjustment Mode.
- Select the VPOS item with **1** and **4**.
- Adjust value of VPOS with **3** and **6** for the best vertical center.
- Press **MUTING** then **ENTER** to save into the memory.

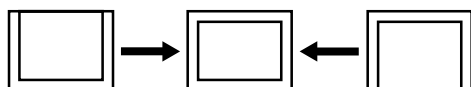

#### 4-5-9. H. CENTER ADJUSTMENT (HPOS)

Perform this adjustment after performing H. Frequency (Free Run) Check.

- Input a crosshatch signal.
- Activate the Service Adjustment Mode.
- Select the HPOS item with **1** and **4**.
- Adjust the value of HPOS with **3** and **6** for the best horizontal center.
- Press **MUTING** then **ENTER** to save into the memory.

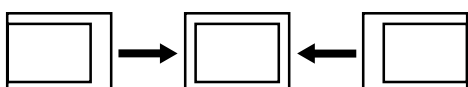

#### 4-5-10.H. SIZE ADJUSTMENT (HSIZ)

- Input a monoscope signal.
- Activate the Service Adjustment Mode.
- Select HSIZ with **1** and **4**.
- Adjust with **3** and **6** for the best horizontal size.
- Press **MUTING** then **ENTER** to save into the memory.

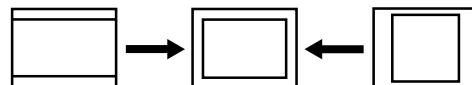

#### 4-5-11.V. LINEARITY (VLIN), V. CORRECTION (SCOR), PIN AMP (PAMP), AND HORIZONTAL TRAPEZOID (HTRP) ADJUSTMENTS

- Input a crosshatch signal.
- Activate the Service Adjustment Mode.
- Select VLIN, SCOR, PAMP, and HTRP with **1** and **4**.
- Adjust with **3** and **6** for the best horizontal size.
- Press **MUTING** then **ENTER** to save into the memory.

V LINEARITY (VLIN)

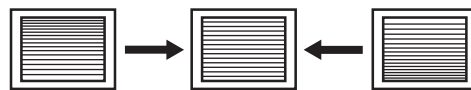

V CORRECTION (SCOR)

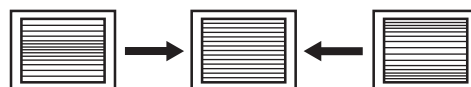

PIN AMP (PAMP)



HORIZONTAL TRAPEZOID (HTRP)

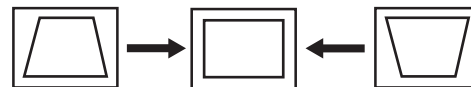

#### 4-5-12.V. ANGLE (VANG), V. BOW (VBOW), UPPER PIN (UPIN) AND LOW PIN (LPIN) ADJUSTMENTS

1. Input a crosshatch signal.
2. Activate the Service Adjustment Mode.
3. Select VANG, VBOW, UPIN, and LPIN with **1** and **4**.
4. Adjust with **3** and **6** for the best picture.
5. Press **MUTING** then **ENTER** to save into the memory.

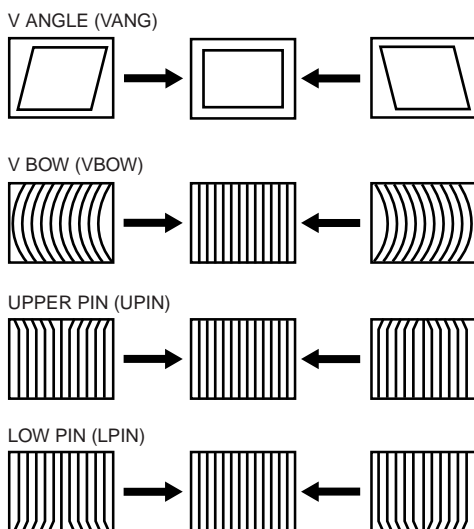

#### 4-5-13.SERVICE ADJUSTMENT MODE MEMORY

1. After completing all adjustments, press **0** then **ENTER**.

Read From Memory

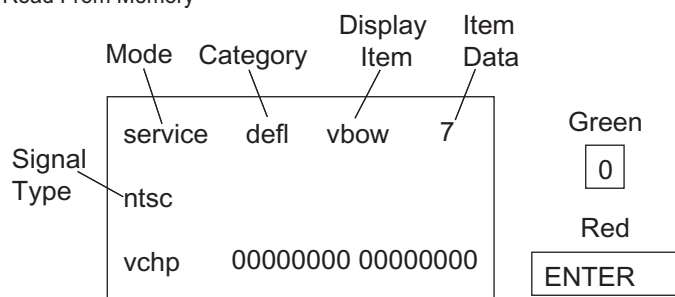





## SECTION 5: DIAGRAMS

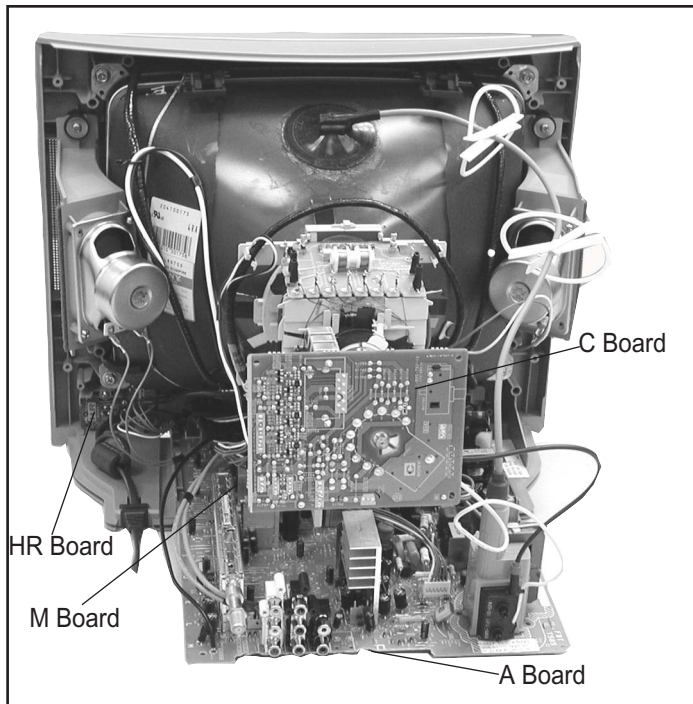

### 5-1. CIRCUIT BOARDS LOCATION



The components identified by  in this basic schematic diagram have been carefully factory-selected for each set in order to satisfy regulations regarding X-ray radiation. Should replacement be necessary, replace only with the value originally used.

When replacing components identified by , make the necessary adjustments as indicated. If the results do not meet the specified value, change the component identified by  and repeat the adjustment until the specified value is achieved. (Refer to Section 3: Safety Related Adjustments on Page 15.)

When replacing the parts listed in the table below, it is important to perform the related adjustments.

Part Replaced (  )	Adjustment (  )
DY, T585, CRT, IC001, IC561, C507, C508, C506, L511, L510, C588, L588, C566, C561, C563, D567, D568, D566, R567, R568, R565, R566, R562, R563, R561, R528.....A Board	HV HOLD-DOWN R565

### 5-2. PRINTED WIRING BOARD AND SCHEMATIC DIAGRAM INFORMATION

All capacitors are in  $\mu\text{F}$  unless otherwise noted. pF :  $\mu\text{F}$  50WV or less are not indicated except for electrolytics and tantalums.

All electrolytics are in 50V unless otherwise specified.

All resistors are in ohms. k=1000, M=1000k

Indication of resistance, which does not have one for rating electrical power, is as follows: Pitch : 5mm Rating electrical power :

$\frac{1}{4}$  W in resistance,  $\frac{1}{10}$  W and  $\frac{1}{8}$  W in chip resistance.

: nonflammable resistor.

: fusible resistor.

: internal component.

: panel designation and adjustment for repair.

All variable and adjustable resistors have characteristic curve B, unless otherwise noted.

Readings are taken with a color-bar signal input.

Readings are taken with a 10M digital multimeter.

Voltages are DC with respect to ground unless otherwise noted.

Voltage variations may be noted due to normal production tolerances.

All voltages are in V.

S : Measurement impossibility.

 : B-line. (Actual measured value may be different).

: signal path. (RF)

Circled numbers are waveform references.

### REFERENCE INFORMATION

RESISTOR	: RN	METAL FILM
	: RC	SOLID
	: FPRD	NONFLAMMABLE CARBON
	: FUSE	NONFLAMMABLE FUSIBLE
	: RW	NONFLAMMABLE WIREWOUND
	: RS	NONFLAMMABLE METAL OXIDE
	: RB	NONFLAMMABLE CEMENT
	: 	ADJUSTMENT RESISTOR

COIL : LF-8L MICRO INDUCTOR

CAPACITOR	: TA	TANTALUM
	: PS	STYROL
	: PP	POLYPROPYLENE
	: PT	MYLAR
	: MPS	METALIZED POLYESTER
	: MPP	METALIZED POLYPROPYLENE
	: ALB	BIPOLAR
	: ALT	HIGH TEMPERATURE
	: ALR	HIGH RIPPLE

The components identified by shading and  symbol are critical for safety. Replace only with part number specified.

The symbol  indicates a fast operating fuse and is displayed on the component side of the board. Replace only with fuse of the same rating as marked.

Les composants identifiés par un trame et une marque  sont critiques pour la sécurité. Ne les remplacer que par une pièce portant le numéro spécifié.

Le symbole  indique une fusible à action rapide. Doit être remplacé par une fusible de même valeur, comme marqué.

5.3 BLOCK DIAGRAMS

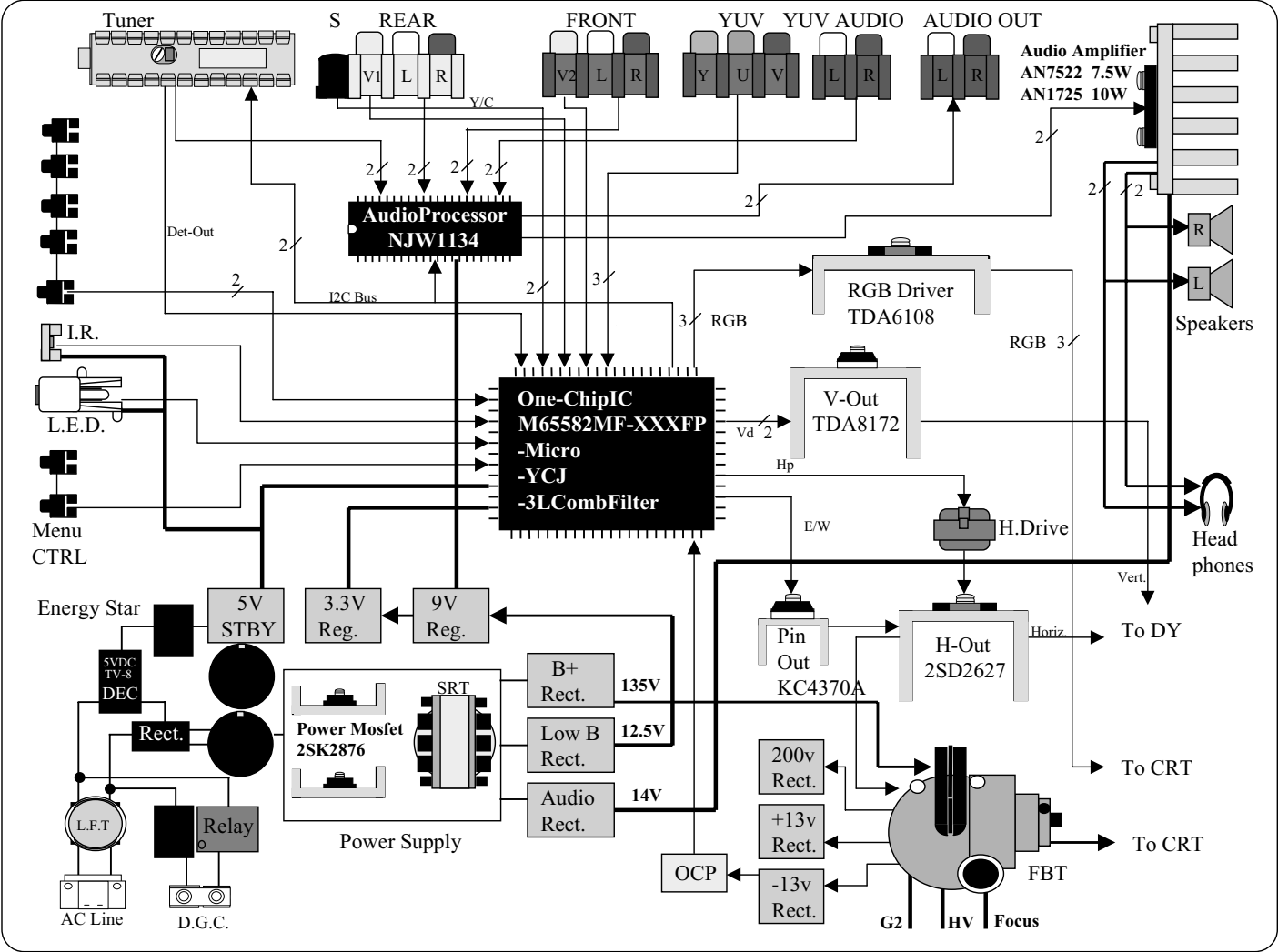

5-4. SCHEMATIC DIAGRAMS AND SUPPORTING INFORMATION

A BOARD SCHEMATIC DIAGRAM

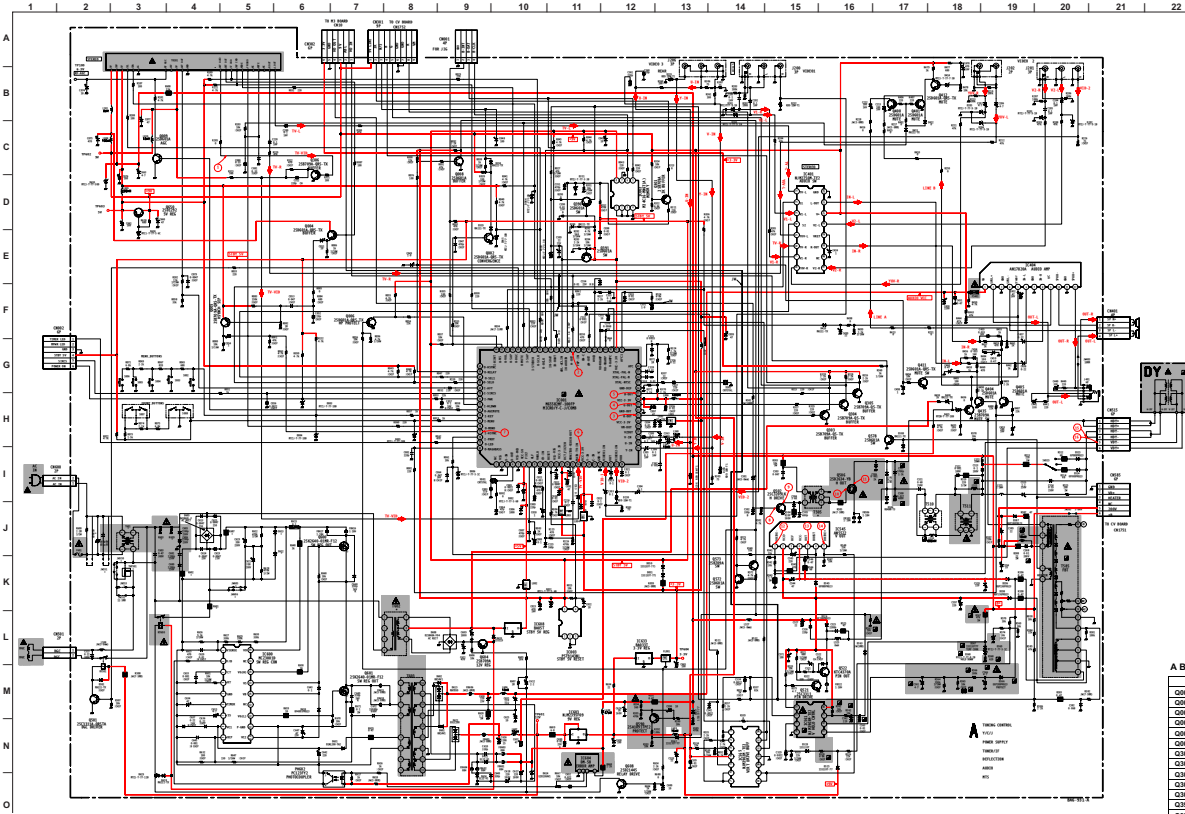

A BOARD WAVEFORMS

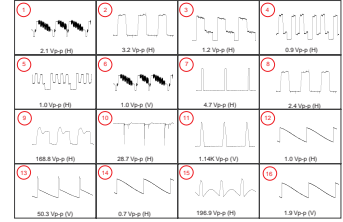

A BOARD IC VOLTAGE LIST

IC#	PN	VOLT	IC#	PN	VOLT	IC#	PN	VOLT
1	NC	37	1	NC	5	1	NC	5
2	0.00	18	2	0.00	11	4.4	6	182.2
3	2.2	39	3	0.1	75	6.0	12	0.0
4	2.2	40	4	2.0	70	0.0	13	4.5
5	0.00	41	5	1.6	77	0.5	14	5.0
6	5.0	42	6	3.3	78	0.0	15	4.4
7	0.0	43	7	NC	79	4.8	16	0.0
8	0.0	44	8	1.6	80	4.8	17	3.4
9	0.3	45	9	1.6	81	0.0	18	0.0
10	2.1	46	10	2.3	82	13.6	19	0.0
11	5.0	47	11	1.0	1	0.0	20	5.0
12	0.00	48	12	NC	2	0.0	21	0.0
13	3.3	49	13	0.5	3	0.0	22	1.0
14	0.1	50	14	1.2	4	7.0	23	1.0
15	1.6	51	15	4.0	5	0.0	24	0.0
16	0.0	52	16	1.6	6	4.8	25	0.0
17	3.3	53	17	4.8	7	0.0	26	0.0
18	0.0	54	18	4.8	8	0.0	27	0.0
19	1.1	55	19	4.8	9	0.0	28	0.0
20	0.00	56	20	4.8	10	0.0	29	0.0
21	0.0	57	21	NC	11	12	7.0	
22	1.7	58	22	5.2	12	0.0	30	0.0
23	0.0	59	23	0.0	13	0.0	31	0.0
24	0.0	60	24	0.0	14	0.0	32	0.0
25	0.0	61	25	0.0	15	0.0	33	0.0
26	0.0	62	26	0.0	16	0.0	34	0.0
27	0.0	63	27	1.4	17	0.0	35	0.0
28	2.1	64	28	4.9	18	0.0	36	0.0
29	2.7	65	29	4.9	19	0.0	37	0.0
30	3.3	66	30	0.0	20	0.0	38	0.0
31	2.0	67	31	0.4	21	0.0	39	0.0
32	0.00	68	32	0.1	22	0.0	40	0.0
33	2.8	69	33	2.4	23	0.0	41	0.0
34	3.3	70	34	0.0	24	0.0	42	0.0

A BOARD TRANSISTOR VOLTAGE LIST

Q#	B	C	E	Q#	B	C	E
Q202	0.0	2.0	0.00	Q405	0.0	0.0	0.00
Q204	3.8	0.0	4.4	Q411	0.0	0.0	0.00
Q205	0.1	0.8	0.0	Q412	0.1	0.1	0.00
Q206	0.0	0.0	0.00	Q451	0.0	0.0	0.00
Q208	0.0	2.8	0.00	Q501	0.0	14.3	0.00
Q209	0.0	5.2	0.00	Q502	0.0	12.4	0.00
Q301	3.0	2.1	3.0	Q506	0.0	131.8	0.00
Q303	3.8	0.00	2.8	Q521	0.0	3.8	0.00
Q304	3.6	0.00	3.6	Q522	0.1	2.4	0.00
Q305	3.0	0.00	3.0	Q572	0.0	2.8	0.00
Q306	5.5	0.00	4.9	Q573	2.6	0.0	2.6
Q309	0.8	1.6	1.8	Q578	0.0	0.8	0.00
Q391	0.6	3.3	1.5	Q590	133.7	0.0	134.2
Q400	0.0	0.1	0.00	Q604	30.6	11.9	30.2
Q401	0.0	0.1	0.00	Q605	0.0	0.7	0.00
Q404	0.0	0.0	0.00	Q650	5.8	0.0	0.00

**A** [POWER SUPPLY, DEFLECTION, TUNER/IF, AUDIO, MTS, TUNING CONTROL, Y-C JUNGLE]

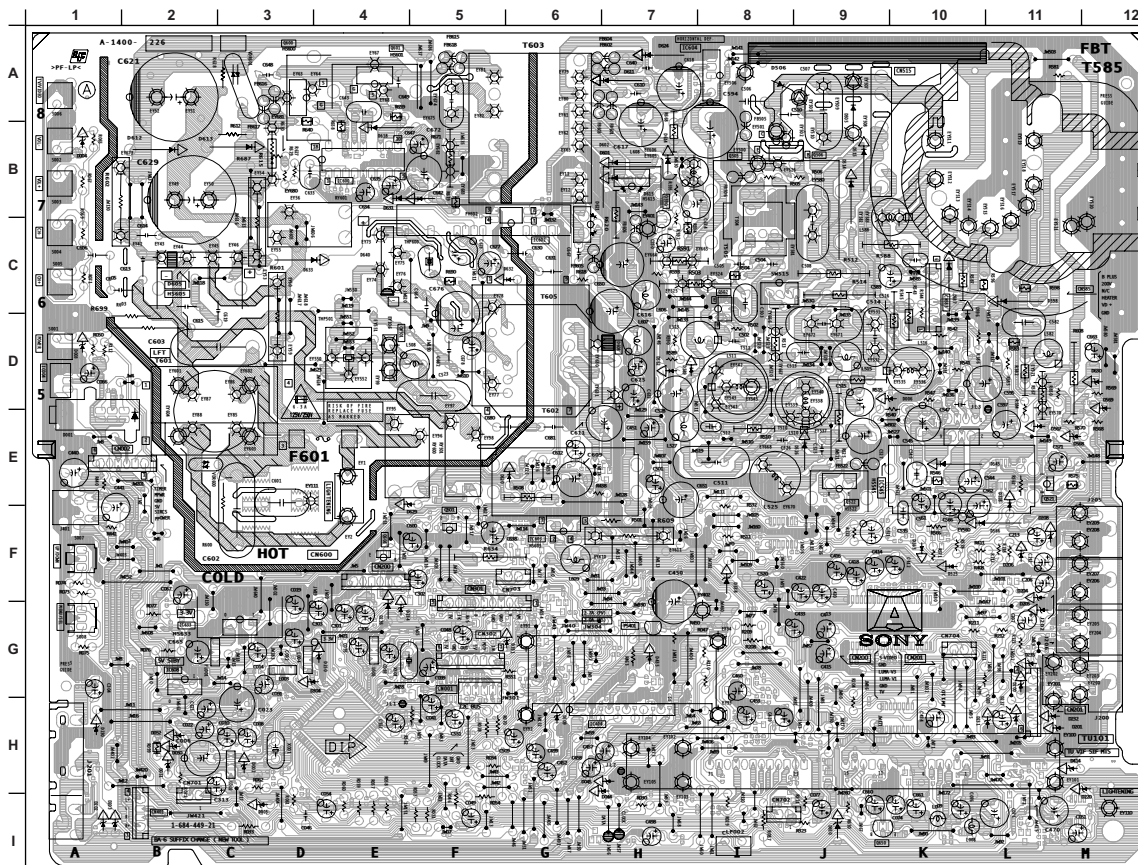

#### A BOARD LOCATOR LIST

D002	B-3	D559	F-8	IC604	I-8
D003	F-1	D562	F-7	IC608	C-2
D004	H-1	D566	D-11	IC633	C-3
D005	A-3	D567	E-11	<b>TRANSISTORS</b>	
D006	F-10	D568	E-11	Q002	B-6
D044	A-6	D569	F-12	Q004	A-11
D045	B-7	D587	G-10	Q005	A-11
D050	B-2	D589	F-8	Q006	D-6
D051	B-2	D596	F-10	Q008	C-2
D052	B-2	D598	F-11	Q009	B-10
D200	B-11	D601			
D201	B-11	D602		Q301	D-5
D202	A-1	D605	G-3	Q303	D-5
D203	A-1	D608	F-7	Q304	D-5
D204	C-11	D611	I-7	Q305	C-5
D205	C-11	D612	B-2	Q306	A-8
D230	B-1	D613	B-3	Q390	C-7
D232	B-11	D614	H-7	Q391	C-6
D234	C-5	D615	H-7	Q400	C-10
D235	C-11	D618	H-5	Q401	C-10
D236	C-4	D620	E-6	Q404	C-8
D351	C-6	D621	G-6	Q405	C-8
D390	C-7	D624	I-7	Q411	A-6
D410	B-5	D628	E-5	Q412	B-11
D412	B-11	D629	E-4	Q435	G-7
D413	A-11	D630	F-12	Q501	D-5
D414	B-11	D631	H-5	Q502	G-8
D435	G-7	D650	A-9	Q506	
D438	G-7		<b>IC</b>	Q521	D-11
D501	E-5	IC001	B-4	Q522	E-9
D505	I-9	IC002	B-5	Q572	D-6
D506	I-8	IC003	B-3	Q573	D-6
D508	D-10			Q578	D-10
D509	C-6	IC401	B-9	Q590	G-7
D514	H-9	IC404	B-7	Q600	I-3
D515	H-10	IC545	E-10	Q601	I-4
D525	D-10	IC561	E-11	Q604	E-7
D526	E-9	IC565	D-8	Q608	F-4
D528	D-11	IC600	H-4	Q650	A-9
D545	E-10				

C BOARD SCHEMATIC DIAGRAM

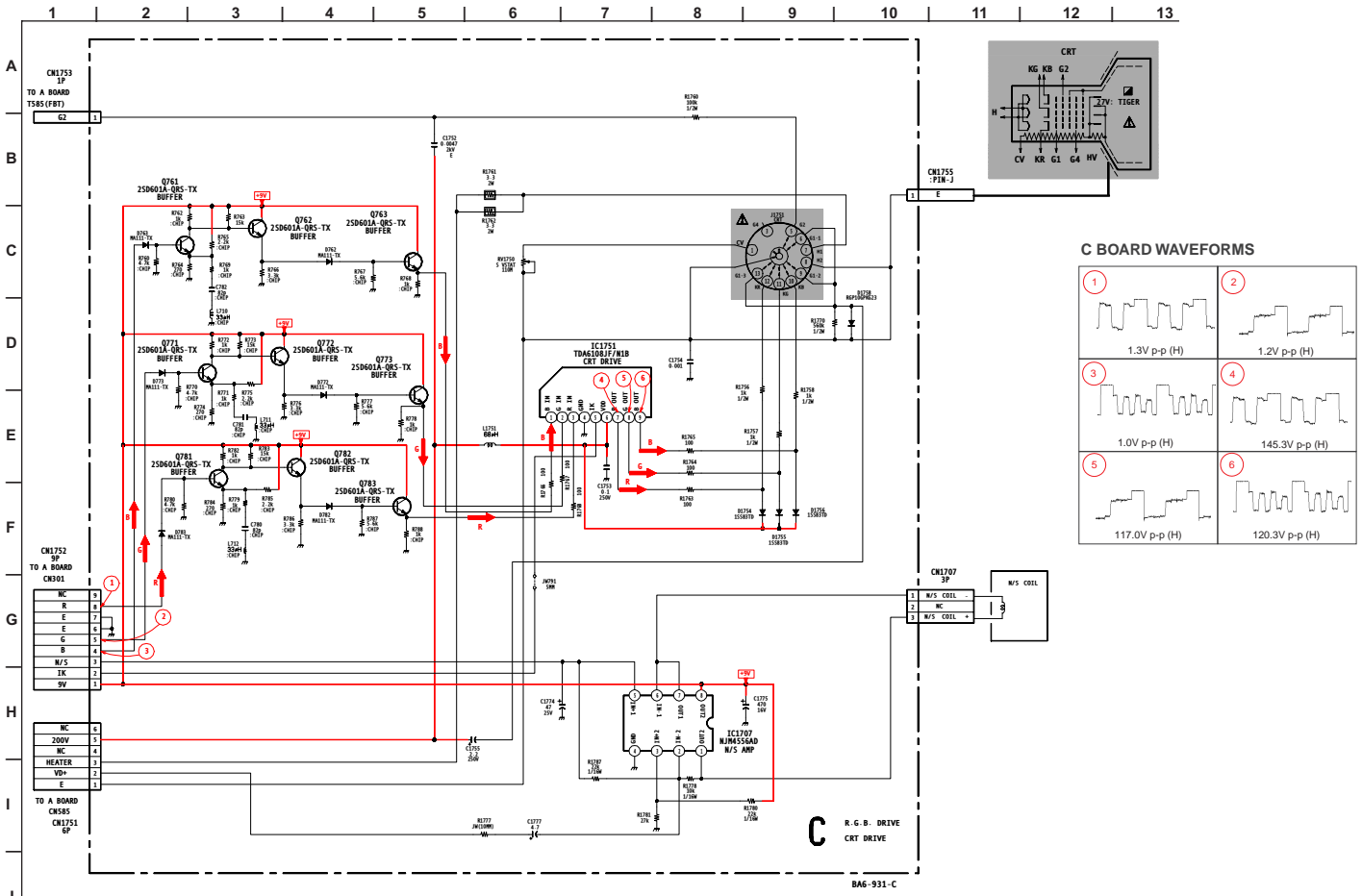

**C BOARD IC VOLTAGE LIST**

IC1707	
PIN	VOLT
1	1.8
2	2.8
3	4.4
4	GND
5	4.8
6	4.8
7	4.8
8	9.0
IC1751	
PIN	VOLT
1	2.0
2	2.0
3	2.4
4	GND
5	3.7
6	200.0
7	136.0
8	142.0
9	140.0

All voltages are in V.

**C BOARD TRANSISTOR VOLTAGE LIST**

	B	C	E
Q761	2.2	3.8	2.9
Q762	3.1	9.0	3.8
Q763	2.0	9.0	2.6
Q771	2.2	3.8	2.9
Q772	3.2	9.0	3.8
Q773	2.0	9.0	2.6
Q781	2.2	3.9	2.9
Q782	3.3	9.0	3.9
Q783	2.1	9.0	2.7

All voltages are in V.

**C** [RGB DRIVE, CRT DRIVE, VELOCITY MODULATION]

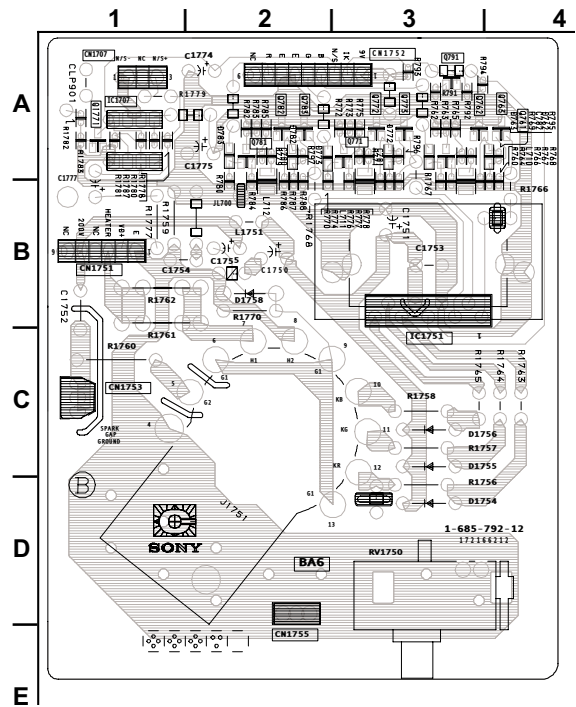



M BOARD SCHEMATIC DIAGRAM

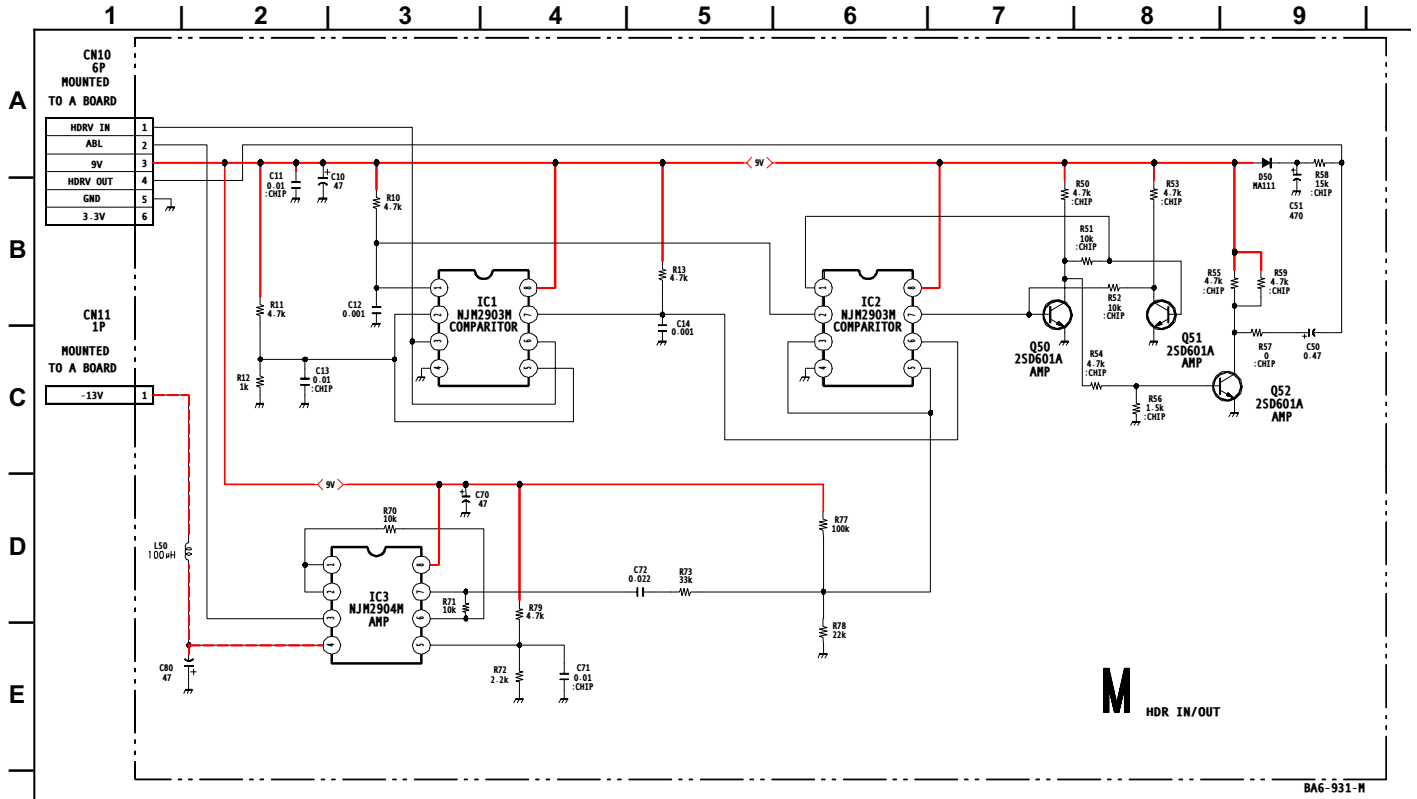

M BOARD CN VOLTAGE LIST

CN10		3	9.0	CN11	
PIN	VOLT	4	0.0	PIN	VOLT
1	0.5	5	GND	1	-13.0
2	1.0	6	N/C		

All voltages are in V.



[HDR IN/OUT] COMPONENT SIDE

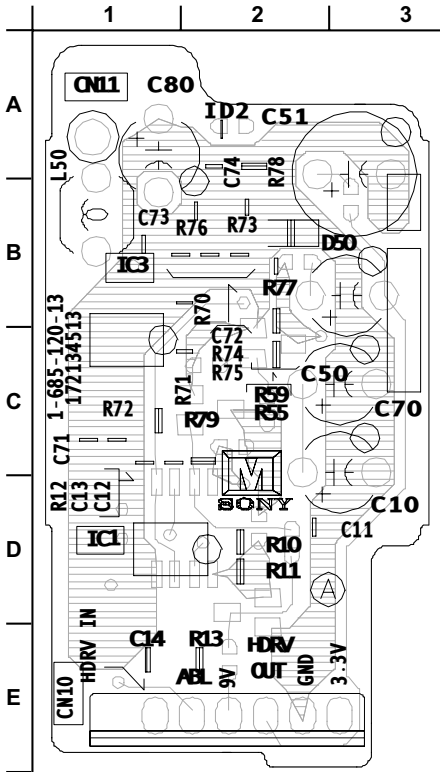

CONDUCTOR SIDE

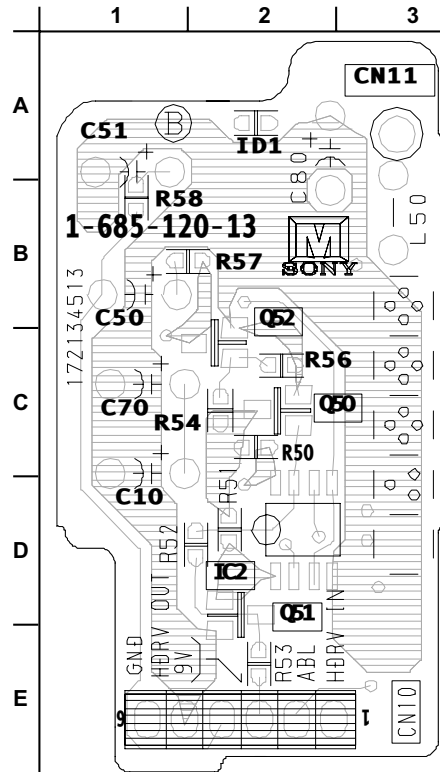



HR BOARD SCHEMATIC DIAGRAM

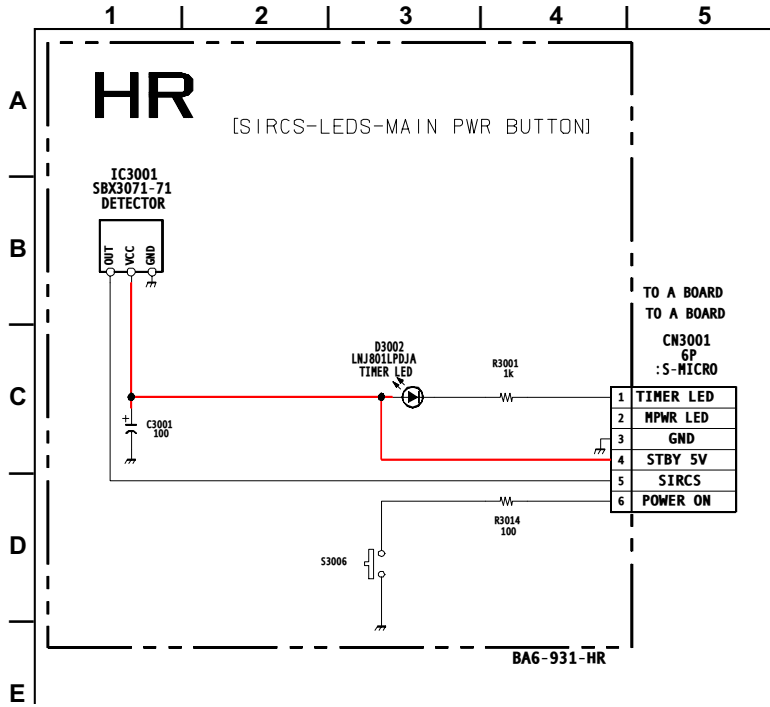

HR [SIRCS/LEDS/MAIN PWR BUTTON] COMPONENT SIDE

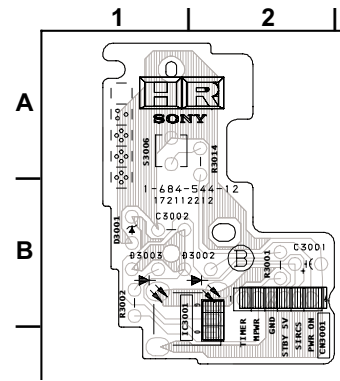

## 5-5. SEMICONDUCTORS

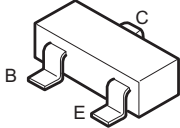
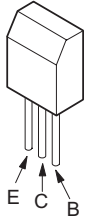
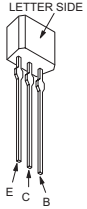
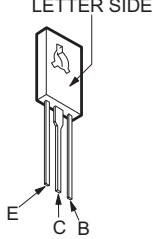
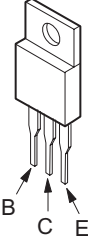
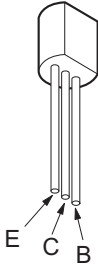
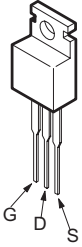
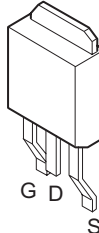
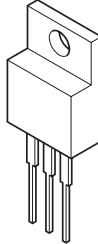
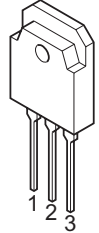
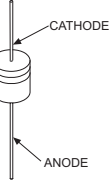
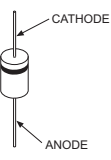
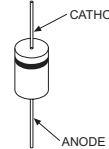
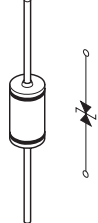
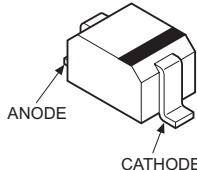
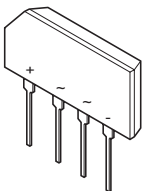
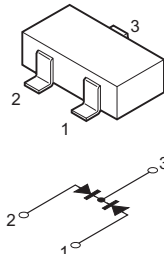
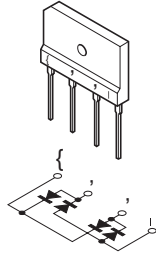
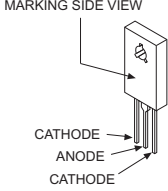
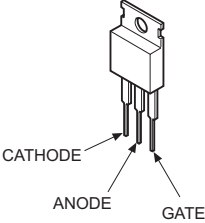
<p>2SB709A-QRS-TX 2SD601A-QRS-TX</p> 	<p>2SB734-T-34 2SC3209LK-TP</p> 	<p>2SA1309A-QRSTA 2SC3311A-QRSTA 2SD2144S-TP-UVW</p> 	<p>2SC3840K</p> 	<p>2SA1837</p> 
<p>2SA10910-TPE2</p> 	<p>IRF614</p> 	<p>2SK2663</p> 	<p>2SC4793</p> 	<p>2SD2578-YB</p> 
<p>ERA38-06TP1 ERA82-004TP5 1SS133T-77 D1NSOR-TA MTZJ-T-77-12C MTZJ-T-77-15B MTZJ-T-77-33B MTZJ-T-77-39</p> 	<p>RU-1P ERC06-15S EGP20DPKG23 MTZJ-T-77-5.1C MTZJ-T-77-5.6C MTZJ-T-77-7.5A MTZJ-T-77-10B MTZJ-T-77-30D RGP10-GPKG3 RGP02-17PKG23</p> 	<p>ERB44-06TP1 1SS83TD GP08DPKG23 RGP10GPKG23 RU4AM-T3</p> 	<p>RD9.1EW-T1</p> 	<p>MA111-TX UDZ-TE-17.5.1B UDZ-TE-17.91B</p> 
<p>D2SB60A-F04</p> 	<p>DAP202K-T-146</p> 	<p>D4SB60L-F</p> 		
<p>D5LC20U</p> 	<p>TF541M</p> 			

## SECTION 6: EXPLODED VIEWS

Components not identified by a part number or description are not stocked because they are seldom required for routine service.

The component parts of an assembly are indicated by the reference numbers in the far right column of the parts list and within the dotted lines of the diagram.

\* Items marked with an asterisk are not stocked since they are seldom required for routine service. Expect some delay when ordering these components.

**NOTE:** The components identified by shading and  $\triangle$  mark are critical for safety. Replace only with part number specified.

**NOTE:** Les composants identifiés par un trame et une marque  $\triangle$  sont critiques pour la sécurité. Ne les remplacer que par une pièce portant le numéro spécifié.

## 6-1. CHASSIS (KV-13FS100/14FV300 ONLY)

- 7-685-648-79 SCREW +BVTP 3X12 TYPE2 IT-3
- 7-685-663-71 SCREW +BVTP 4X16 TYPE2 N-S
- ▲ 4-365-808-01 SCREW (5), TAPPING
- ★ 4-384-096-01 SCREW (4X16), TAPPING, +P

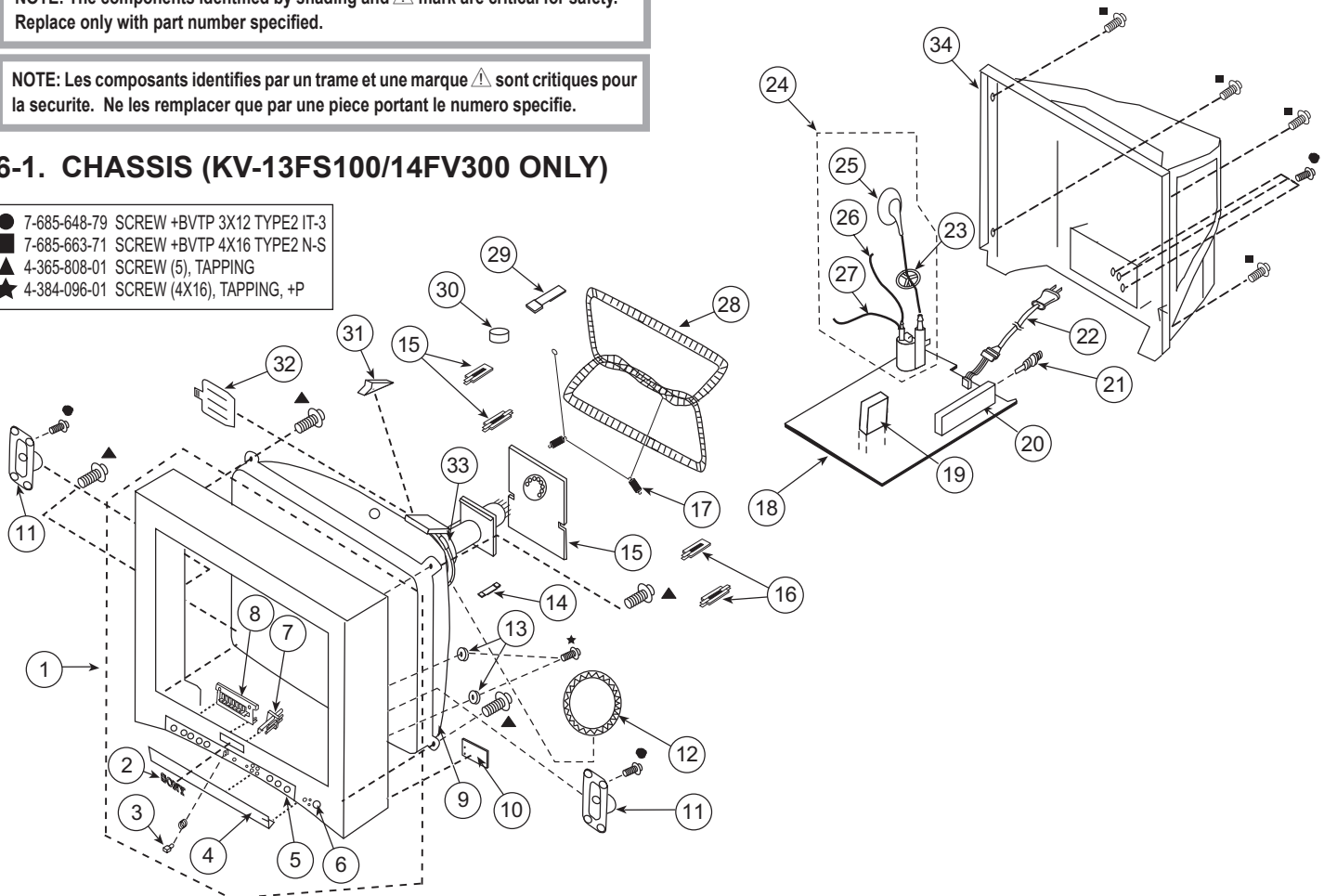

REF. NO.	PART NO.	DESCRIPTION	[ASSEMBLY INCLUDES]	REF. NO.	PART NO.	DESCRIPTION	[ASSEMBLY INCLUDES]
1	X-4040-209-1	BEZNET ASSY	(2-8)	*	19	A-1401-047-A	M (VAR) MOUNTED PC BOARD
2	4-056-190-11	EMBLEM (NO. 6), SONY		$\triangle$	20	8-598-593-30	TUNER, FSS BTF-WA421
3	4-042-192-01	CATCHER, PUSH		$\triangle$	21	1-766-374-11	PLUG, F-PIN
4	4-088-377-21	DOOR		$\triangle$	22	1-824-082-11	CORD, AC POWER (WITH CONNECTOR) (KV-13FS100/14FV300 NORTH ONLY)
5	4-074-895-71	LABEL, FRONT TERMINAL (20")		$\triangle$	22	1-824-081-11	AC POWER CORD (KV-14FV300 SOUTH ONLY)
6	4-088-376-01	BUTTON, POWER		23	4-084-918-01	HOLDER, HV CABLE	
7	4-088-375-01	LED GUIDE		$\triangle$	24	1-453-339-11	FBT ASSY NX-1912//M3E4 (25-27)
8	4-087-151-01	BUTTON, MULTI		$\triangle$	25	1-473-159-11	CAP ASSY, HIGH-VOLTAGE
$\triangle$ 9	8-735-570-05	CRT 14RSN		$\triangle$	26	1-900-800-65	CONNECTOR ASSY, FOCUS LEAD
* 10	A-1400-251-A	HR (COM) MOUNTED PC BOARD		$\triangle$	27	1-900-803-22	WIRE ASSY, G2 LEAD
11	1-825-070-11	SPEAKER (5X9CM)		$\triangle$	28	1-419-559-21	COIL, DEGAUSSING
$\triangle$ 12	1-452-728-61	COIL, NA ROTATION (RT-154)		29	4-083-415-01	PIECE A(75), CONV CORRECT	
13	4-374-745-31	CUSHION (A)		30	1-452-032-00	MAGNET, DISC	
14	4-059-492-01	PERMALLOY (75), CONV.CORRECT		31	4-053-005-01	SPACER, DY	
* 15	A-1401-049-A	C MOUNTED PC BOARD		32	4-081-170-01	PLATE, TLH CORRECTION	
16	4-069-972-01	CLIP (14RSN), DGC		$\triangle$ 33	8-451-401-11	DY Y14RSA-S	
* 17	4-375-394-01	SPRING, TENSION		34	4-088-374-01	COVER, REAR	
* 18	A-1300-544-A	A COMPLETE PC BOARD (KV-13FS100/4FV300 NORTH ONLY)					
		The high voltage leads associated with the FBT on the A Board are not included and must be ordered separately. (See 25-27)					
* 18	A-1300-636-A	A COMPLETE PC BOARD (KV-14FV300 SOUTH ONLY)					
		The high voltage leads associated with the FBT on the A Board are not included and must be ordered separately. (See 25-27)					





NOTE: The components identified by shading and  $\triangle$  mark are critical for safety. Replace only with part number specified.

NOTE: Les composants identifiés par un trame et une marque  $\triangle$  sont critiques pour la sécurité. Ne les remplacer que par une pièce portant le numéro spécifique.



REF. NO.	PART NO.	DESCRIPTION	VALUES			REF. NO.	PART NO.	DESCRIPTION	VALUES		
C203	1-107-826-11	CERAMIC CHIP	0.1 $\mu$ F	10%	16V	C503	1-106-383-00	MYLAR	0.047 $\mu$ F	10%	200V
C204	1-107-826-11	CERAMIC CHIP	0.1 $\mu$ F	10%	16V	C504	1-249-426-11	CARBON	5.6K	5%	1/4W
C205	1-107-826-11	CERAMIC CHIP	0.1 $\mu$ F	10%	16V	C505	1-102-002-00	CERAMIC	680pF	10%	500V
C206	1-126-963-11	ELECT	4.7 $\mu$ F	20%	50V	$\triangle$ C506	1-117-214-11	CERAMIC	0.001 $\mu$ F	10%	2KV
C207	1-126-963-11	ELECT	4.7 $\mu$ F	20%	50V	$\triangle$ C507	1-119-865-11	FILM	5700pF	3%	1.5KV
C212	1-126-933-11	ELECT	100 $\mu$ F	20%	16V	$\triangle$ C508	1-129-719-00	FILM	0.027 $\mu$ F	5%	400V
C213	1-126-933-11	ELECT	100 $\mu$ F	20%	16V	C509	1-128-551-11	ELECT	22 $\mu$ F	20%	25V
C220	1-107-826-11	CERAMIC CHIP	0.1 $\mu$ F	10%	16V	C511	1-109-844-11	FILM	0.68 $\mu$ F	5%	250V
C303	1-126-956-91	ELECT	0.1 $\mu$ F	20%	50V	C512	1-104-987-11	MYLAR	0.001 $\mu$ F	10%	100V
C304	1-126-956-91	ELECT	0.1 $\mu$ F	20%	50V	C513	1-104-999-11	MYLAR	0.1 $\mu$ F	10%	200V
C305	1-107-826-11	CERAMIC CHIP	0.1 $\mu$ F	10%	16V	C514	1-117-666-11	FILM	0.39 $\mu$ F	5%	250V
C306	1-107-826-11	CERAMIC CHIP	0.1 $\mu$ F	10%	16V	C515	1-107-649-11	ELECT	2.2 $\mu$ F	20%	250V
C307	1-107-826-11	CERAMIC CHIP	0.1 $\mu$ F	10%	16V	C520	1-126-965-91	ELECT	22 $\mu$ F	20%	50V
C312	1-164-230-11	CERAMIC CHIP	220pF	5%	50V	C521	1-126-960-11	ELECT	1 $\mu$ F	20%	50V
C313	1-126-956-91	ELECT	0.1 $\mu$ F	20%	50V	C522	1-162-923-11	CERAMIC CHIP	47pF	5%	50V
C325	1-162-967-11	CERAMIC CHIP	0.0033 $\mu$ F	10%	50V	C523	1-136-346-21	MYLAR	0.22 $\mu$ F	20%	300V
C326	1-127-715-91	CERAMIC CHIP	0.22 $\mu$ F	10%	16V	C525	1-164-646-11	CERAMIC	2200pF	10%	500V
C328	1-162-970-11	CERAMIC CHIP	0.01 $\mu$ F	10%	25V	C526	1-102-244-00	CERAMIC	220pF	10%	500V
C330	1-162-970-11	CERAMIC CHIP	0.01 $\mu$ F	10%	25V	C527	1-107-645-11	ELECT	22 $\mu$ F	20%	160V
C337	1-162-919-11	CERAMIC CHIP	22pF	5%	50V	C529	1-164-690-91	CERAMIC CHIP	0.0022 $\mu$ F	5%	50V
C351	1-164-315-11	CERAMIC CHIP	470pF	5%	50V	C534	1-162-966-11	CERAMIC CHIP	0.0022 $\mu$ F	10%	50V
C360	1-164-230-11	CERAMIC CHIP	220pF	5%	50V	C537	1-162-964-11	CERAMIC CHIP	0.001 $\mu$ F	10%	50V
C361	1-164-230-11	CERAMIC CHIP	220pF	5%	50V	C539	1-162-970-11	CERAMIC CHIP	0.01 $\mu$ F	10%	25V
C362	1-162-964-11	CERAMIC CHIP	0.001 $\mu$ F	10%	50V	C542	1-162-966-11	CERAMIC CHIP	0.0022 $\mu$ F	10%	50V
C363	1-162-964-11	CERAMIC CHIP	0.001 $\mu$ F	10%	50V	C544	1-126-967-11	ELECT	47 $\mu$ F	20%	50V
C370	1-162-969-11	CERAMIC CHIP	0.0068 $\mu$ F	10%	25V	C545	1-126-969-11	ELECT	220 $\mu$ F	20%	50V
C390	1-162-970-11	CERAMIC CHIP	0.01 $\mu$ F	10%	25V	C546	1-137-194-81	FILM	0.47 $\mu$ F	5%	50V
C424	1-126-960-11	ELECT	1 $\mu$ F	20%	50V	C551	1-126-960-11	ELECT	1 $\mu$ F	20%	50V
C440	1-126-940-11	ELECT	330 $\mu$ F	20%	25V	C552	1-126-964-11	ELECT	10 $\mu$ F	20%	50V
C441	1-126-940-11	ELECT	330 $\mu$ F	20%	25V	C553	1-107-826-11	CERAMIC CHIP	0.1 $\mu$ F	10%	16V
C450	1-126-943-11	ELECT	2200 $\mu$ F	20%	25V	C554	1-162-970-11	CERAMIC CHIP	0.01 $\mu$ F	10%	25V
C451	1-126-959-11	ELECT	0.47 $\mu$ F	20%	50V	$\triangle$ C561	1-126-963-11	ELECT	4.7 $\mu$ F	20%	50V
C452	1-126-967-11	ELECT	47 $\mu$ F	20%	50V	$\triangle$ C562	1-104-666-11	ELECT	220 $\mu$ F	20%	25V
C453	1-126-933-11	ELECT	100 $\mu$ F	20%	16V	C563	1-162-970-11	CERAMIC CHIP	0.01 $\mu$ F	10%	25V
C454	1-164-677-11	CERAMIC CHIP	0.033 $\mu$ F	10%	16V	$\triangle$ C566	1-107-635-11	ELECT	4.7 $\mu$ F	20%	160V
C455	1-164-677-11	CERAMIC CHIP	0.033 $\mu$ F	10%	16V	C571	1-104-665-11	ELECT	100 $\mu$ F	20%	25V
C457	1-136-169-00	FILM	0.22 $\mu$ F	5%	50V	C582	1-106-387-00	MYLAR	0.068 $\mu$ F	10%	200V
C458	1-136-169-00	FILM	0.22 $\mu$ F	5%	50V	C588	1-107-364-11	MYLAR	0.01 $\mu$ F	10%	200V
C459	1-137-194-91	FILM	0.47 $\mu$ F	5%	50V	C589	1-128-560-11	ELECT	22 $\mu$ F	20%	100V
C460	1-137-194-91	FILM	0.47 $\mu$ F	5%	50V	$\triangle$ C590	1-126-964-11	ELECT	10 $\mu$ F	20%	50V
C470	1-126-935-11	ELECT	470 $\mu$ F	20%	16V	C594	1-123-024-21	ELECT	33 $\mu$ F		160V
C498	1-126-960-11	ELECT	1 $\mu$ F	20%	50V	C595	1-104-666-11	ELECT	220 $\mu$ F	20%	25V
C499	1-126-965-91	ELECT	22 $\mu$ F	20%	50V	C597	1-104-666-11	ELECT	220 $\mu$ F	20%	25V
C502	1-102-112-00	CERAMIC	330pF	10%	50V	C600	1-126-964-11	ELECT	10 $\mu$ F	20%	50V















NOTE: The components identified by shading and  mark are critical for safety. Replace only with part number specified.

NOTE: Les composants identifiés par un trame et une marque  sont critiques pour la sécurité. Ne les remplacer que par une pièce portant le numéro spécifique.



REF. NO.	PART NO.	DESCRIPTION	VALUES	REF. NO.	PART NO.	DESCRIPTION	VALUES
D505	8-719-081-00	DIODE BY228/A52A/		<b>FUSE</b>			
D506	8-719-979-85	DIODE RGP15GPKG23			F601	1-532-506-51 FUSE (FOR KV-14FV300S ONLY)	6.3A/250V
D508	8-719-404-50	DIODE MA111-TX			F601	1-576-193-11 FUSE (FOR KV-13FS100/13FS110/14FV300N ONLY)	6.3A/125V
D509	8-719-109-66	DIODE MTZJ-T-77-3.3B		<b>FERRITE BEAD</b>			
D514	8-719-908-03	DIODE GP08DPKG23		FB505	1-410-397-21	FERRITE	1.1μH
D515	8-719-908-03	DIODE GP08DPKG23		FB506	1-410-397-21	FERRITE	1.1μH
D525	8-719-991-33	DIODE 1SS133T-77		FB522	1-410-397-21	FERRITE	1.1μH
D526	8-719-302-43	DIODE RGP10GPKG23		FB601	1-412-911-11	FERRITE	0μH
D528	8-719-991-33	DIODE 1SS133T-77		FB602	1-412-911-11	FERRITE	0μH
D545	8-719-908-03	DIODE GP08DPKG23		FB603	1-412-911-11	FERRITE	0μH
D558	8-719-404-50	DIODE MA111-TX		FB604	1-412-911-11	FERRITE	0μH
D559	8-719-404-50	DIODE MA111-TX		FB616	1-469-578-11	FERRITE	1.1μH
 D562	8-719-991-33	DIODE 1SS133T-77		FB617	1-469-578-11	FERRITE	1.1μH
 D566	8-719-979-84	DIODE EGP20DPKG23		<b>FILTER</b>			
 D567	8-719-991-33	DIODE 1SS133T-77		FL001	1-239-803-11	ENCAPSULATED COMPONENT	
D568	8-719-110-08	DIODE MTZJ-T-77-8.2B		<b>IC</b>			
 D569	8-719-921-44	DIODE MTZJ-T-77-5.1C			IC001	6-800-842-01	IC M65582μF-100FP
D587	8-719-302-43	DIODE RGP10GPKG23		IC002	8-759-699-33	IC M24C16-MN6T(A)	
 D589	8-719-991-33	DIODE 1SS133T-77		IC003	8-759-352-91	IC PST9143NL	
D596	8-719-908-03	DIODE GP08DPKG23		IC401	6-701-105-01	IC NJM2750M-TE2	
D598	8-719-908-03	DIODE GP08DPKG23		IC404	6-701-104-01	IC AN17820A	
D601	8-719-312-92	DIODE RK14V1		IC545	8-759-835-98	IC AN5522	
D602	8-719-312-92	DIODE RK14V1			IC561	8-759-700-07	IC NJM2903M-TE2
D605	8-719-510-53	DIODE D4SB60L-F		IC565	8-759-700-44	IC NJM2902M-TE2	
D608	8-719-077-76	DIODE D2SB60A-F04		IC600	8-759-670-30	IC MCZ3001D	
D611	8-719-063-70	DIODE D1NL20U-TA		IC603	8-759-833-71	IC NJM2395F09	
D612	8-719-068-00	DIODE ERC04-06SE (FOR KV-13FS100/13FS110/14FV300N ONLY)			IC604	8-749-012-13	IC DM-58
D613	8-719-068-00	DIODE ERC04-06SE (FOR KV-13FS100/13FS110/14FV300N ONLY)		IC608	8-759-450-47	IC BA05T	
D614	8-719-057-52	DIODE EZ0150AV1		IC633	8-759-445-59	IC BA033T	
D615	6-500-177-01	DIODE MA7D50		<b>JACK</b>			
D618	8-719-979-64	DIODE μF4005PKG23		J200	1-794-118-11	JACK BLOCK, PIN	3P
D620	8-719-911-19	DIODE 1SS119-25TD		J201	1-794-048-11	JACK, PIN	3P
D621	8-719-510-37	DIODE D5LC20U		J202	1-794-116-11	JACK BLOCK, PIN	2P
D624	8-719-063-70	DIODE D1NL20U-TA		J206	1-794-117-11	JACK BLOCK, PIN	3P
D628	8-719-404-50	DIODE MA111-TX		J401	1-568-267-21	JACK	
D629	8-719-110-31	DIODE MTZJ-T-77-12B					
D630	8-719-982-22	DIODE MTZJ-T-77-30D					
D631	8-719-063-70	DIODE D1NL20U-TA2					
D650	8-719-109-89	DIODE MTZJ-T-77-5.6C					

NOTE: The components identified by shading and  $\triangle$  mark are critical for safety. Replace only with part number specified.

NOTE: Les composants identifiés par un trame et une marque  $\triangle$  sont critiques pour la sécurité. Ne les remplacer que par une pièce portant le numéro spécifique.



REF. NO.	PART NO.	DESCRIPTION	VALUES	REF. NO.	PART NO.	DESCRIPTION	VALUES
<b>CHIP CONDUCTOR</b>				L515	1-412-552-11	INDUCTOR	2.2MH
JR102	1-216-864-11	SHORT CHIP	0	L525	1-409-955-11	INDUCTOR	8MH
JR128	1-216-864-11	SHORT CHIP	0	$\triangle$ L588	1-412-528-81	INDUCTOR	18 $\mu$ H
JR200	1-216-864-11	SHORT CHIP	0	L606	1-412-525-31	INDUCTOR	10 $\mu$ H
JR301	1-216-864-11	SHORT CHIP	0	L607	1-412-525-31	INDUCTOR	10 $\mu$ H
JR302	1-216-864-11	SHORT CHIP	0	L608	1-412-533-21	INDUCTOR	47 $\mu$ H
JR303	1-216-864-11	SHORT CHIP	0	L609	1-412-525-31	INDUCTOR	10 $\mu$ H
JR304	1-216-864-11	SHORT CHIP	0	<b>PHOTO COUPLER</b>			
JR305	1-216-864-11	SHORT CHIP	0	PH602	8-749-010-64	PHOTO COUPLER PC123FY2	
JR306	1-216-864-11	SHORT CHIP	0	<b>IC LINK</b>			
JR307	1-216-864-11	SHORT CHIP	0	$\triangle$ PS401	1-576-336-21	LINK, IC	
JR308	1-216-864-11	SHORT CHIP	0	<b>TRANSISTOR</b>			
JR309	1-216-864-11	SHORT CHIP	0	Q002	8-729-422-27	TRANSISTOR 2SD601A-QRS-TX	
JR310	1-216-864-11	SHORT CHIP	0	Q004	8-729-422-27	TRANSISTOR 2SD601A-QRS-TX	
JR311	1-216-864-11	SHORT CHIP	0	Q005	8-729-424-02	TRANSISTOR 2SB709A-QRS-TX	
JR312	1-216-864-11	SHORT CHIP	0	Q006	8-729-422-27	TRANSISTOR 2SD601A-QRS-TX	
JR313	1-216-864-11	SHORT CHIP	0	Q008	8-729-422-27	TRANSISTOR 2SD601A-QRS-TX	
JR314	1-216-864-11	SHORT CHIP	0	Q009	8-729-422-27	TRANSISTOR 2SD601A-QRS-TX	
JR315	1-216-864-11	SHORT CHIP	0	Q301	8-729-424-02	TRANSISTOR 2SB709A-QRS-TX	
JR316	1-216-864-11	SHORT CHIP	0	Q303	8-729-424-02	TRANSISTOR 2SB709A-QRS-TX	
JR317	1-216-864-11	SHORT CHIP	0	Q304	8-729-424-02	TRANSISTOR 2SB709A-QRS-TX	
JR318	1-216-864-11	SHORT CHIP	0	Q305	8-729-424-02	TRANSISTOR 2SB709A-QRS-TX	
JR401	1-216-864-11	SHORT CHIP	0	Q306	8-729-424-02	TRANSISTOR 2SB709A-QRS-TX	
JR500	1-216-864-11	SHORT CHIP	0	Q390	8-729-422-27	TRANSISTOR 2SD601A-QRS-TX	
JR501	1-216-864-11	SHORT CHIP	0	Q391	8-729-422-27	TRANSISTOR 2SD601A-QRS-TX	
JR502	1-216-864-11	SHORT CHIP	0	Q400	8-729-422-27	TRANSISTOR 2SD601A-QRS-TX	
JR860	1-216-864-11	SHORT CHIP	0	Q401	8-729-422-27	TRANSISTOR 2SD601A-QRS-TX	
<b>COIL</b>				Q404	8-729-422-27	TRANSISTOR 2SD601A-QRS-TX	
L002	1-239-803-11	ENCAPSULATED COMPONENT		Q405	8-729-422-27	TRANSISTOR 2SD601A-QRS-TX	
L003	1-239-803-11	ENCAPSULATED COMPONENT		Q411	8-729-422-27	TRANSISTOR 2SD601A-QRS-TX	
L004	1-239-803-11	ENCAPSULATED COMPONENT		Q412	8-729-422-27	TRANSISTOR 2SD601A-QRS-TX	
L005	1-239-803-11	ENCAPSULATED COMPONENT		Q435	8-729-424-02	TRANSISTOR 2SB709A-QRS-TX	
L006	1-412-032-11	INDUCTOR	100 $\mu$ H	Q501	8-729-423-33	TRANSISTOR 2SC3311A-QRSTA	
L007	1-412-032-11	INDUCTOR	100 $\mu$ H	Q502	8-729-140-50	TRANSISTOR 2SC3209LK-TP	
L008	1-410-482-31	INDUCTOR	100 $\mu$ H	$\triangle$ Q506	6-550-042-01	TRANSISTOR 2SD2627LS-YB11	
L009	1-410-482-31	INDUCTOR	100 $\mu$ H	Q521	8-729-423-33	TRANSISTOR 2SC3311A-QRSTA	
L010	1-412-029-11	INDUCTOR	10 $\mu$ H	Q522	8-729-053-87	TRANSISTOR KTC4370A	
L101	1-414-229-11	FERRITE	0 $\mu$ H	Q572	8-729-422-27	TRANSISTOR 2SD601A-QRS-TX	
L360	1-412-029-11	INDUCTOR	10 $\mu$ H	Q573	8-729-424-02	TRANSISTOR 2SB709A-QRS-TX	
L361	1-412-029-11	INDUCTOR	10 $\mu$ H	Q578	8-729-422-27	TRANSISTOR 2SD601A-QRS-TX	
L510	1-406-982-41	INDUCTOR	680 $\mu$ H	$\triangle$ Q590	8-729-200-17	TRANSISTOR 2SA10910-TPE2	
$\triangle$ L511	1-419-488-11	COIL, HORIZONTAL LINEARITY		Q600	8-729-052-29	TRANSISTOR 2SK2876-01MR-F122	
L513	1-406-677-11	INDUCTOR	10MH				





REF. NO.	PART NO.	DESCRIPTION	VALUES			REF. NO.	PART NO.	DESCRIPTION	VALUES		
Q601	8-729-052-29	TRANSISTOR 2SK2876-01MR-F122				R061	1-249-429-11	CARBON	10K	5%	1/4W
Q604	8-729-424-02	TRANSISTOR 2SB709A-QRS-TX				R062	1-249-413-11	CARBON	470	5%	1/4W
Q608	8-729-922-37	TRANSISTOR 2SD2144S-TP-UVW				R063	1-216-829-11	RES-CHIP	4.7K	5%	1/10W
Q650	8-729-926-14	TRANSISTOR 2SD1292				R065	1-249-415-11	CARBON	680	5%	1/4W
		<b>RESISTOR</b>				R067	1-249-416-11	CARBON	820	5%	1/4W
R001	1-216-813-11	RES-CHIP	220	5%	1/10W	R069	1-249-421-11	CARBON	2.2K	5%	1/4W
R002	1-216-864-11	SHORT CHIP	0			R070	1-249-409-11	CARBON	220	5%	1/4W
R003	1-216-821-11	RES-CHIP	1K	5%	1/10W	R071	1-249-427-11	CARBON	6.8K	5%	1/4W
R004	1-216-817-11	RES-CHIP	470	5%	1/10W	R072	1-249-425-11	CARBON	4.7K	5%	1/4W
R006	1-216-829-11	RES-CHIP	4.7K	5%	1/10W	R073	1-249-419-11	CARBON	1.5K	5%	1/4W
R015	1-216-833-11	RES-CHIP	10K	5%	1/10W	R074	1-249-421-11	CARBON	2.2K	5%	1/4W
R027	1-218-732-11	METAL CHIP	47K	0.50%	1/16W	R075	1-249-427-11	CARBON	6.8K	5%	1/4W
R028	1-249-409-11	CARBON	220	5%	1/4W	R076	1-247-807-31	CARBON	100	5%	1/4W
R029	1-249-409-11	CARBON	220	5%	1/4W	R080	1-216-833-11	RES-CHIP	10K	5%	1/10W
R030	1-249-409-11	CARBON	220	5%	1/4W	R081	1-216-841-11	RES-CHIP	47K	5%	1/10W
R031	1-216-813-11	RES-CHIP	220	5%	1/10W	R082	1-216-857-11	RES-CHIP	1M	5%	1/10W
R032	1-216-813-11	RES-CHIP	220	5%	1/10W	R083	1-216-847-11	RES-CHIP	150K	5%	1/10W
R033	1-249-409-11	CARBON	220	5%	1/4W	R084	1-216-819-11	RES-CHIP	680	5%	1/10W
R035	1-216-809-11	RES-CHIP	100	5%	1/10W	R085	1-216-864-11	SHORT CHIP	0		
R036	1-216-829-11	RES-CHIP	4.7K	5%	1/10W	R086	1-216-821-11	RES-CHIP	1K	5%	1/10W
R037	1-216-833-11	RES-CHIP	10K	5%	1/10W	R087	1-247-807-31	CARBON	100	5%	1/4W
R038	1-216-821-11	RES-CHIP	1K	5%	1/10W	R090	1-216-837-11	RES-CHIP	22K	5%	1/10W
R039	1-216-815-11	RES-CHIP	330	5%	1/10W	R091	1-216-841-11	RES-CHIP	47K	5%	1/10W
R040	1-216-829-11	RES-CHIP	4.7K	5%	1/10W	R092	1-216-825-11	RES-CHIP	2.2K	5%	1/10W
R041	1-216-829-11	RES-CHIP	4.7K	5%	1/10W	R093	1-216-841-11	RES-CHIP	47K	5%	1/10W
R042	1-216-813-11	RES-CHIP	220	5%	1/10W	R094	1-414-229-11	FERRITE	0μH		
R043	1-216-813-11	RES-CHIP	220	5%	1/10W	R095	1-414-229-11	FERRITE	0μH		
R044	1-216-829-11	RES-CHIP	4.7K	5%	1/10W	R096	1-216-829-11	RES-CHIP	4.7K	5%	1/10W
R045	1-216-829-11	RES-CHIP	4.7K	5%	1/10W	R098	1-216-839-11	RES-CHIP	33K	5%	1/10W
R047	1-249-409-11	CARBON	220	5%	1/4W	R101	1-216-829-11	RES-CHIP	4.7K	5%	1/10W
R048	1-216-829-11	RES-CHIP	4.7K	5%	1/10W	R102	1-216-837-11	RES-CHIP	22K	5%	1/10W
R049	1-216-829-11	RES-CHIP	4.7K	5%	1/10W	R103	1-216-833-11	RES-CHIP	10K	5%	1/10W
R050	1-249-425-11	CARBON	4.7K	5%	1/4W	R105	1-216-864-11	SHORT CHIP	0		
R051	1-249-417-11	CARBON	1K	5%	1/4W	R107	1-216-809-11	RES-CHIP	100	5%	1/10W
R052	1-216-813-11	RES-CHIP	220	5%	1/10W	R108	1-216-809-11	RES-CHIP	100	5%	1/10W
R053	1-249-433-11	CARBON	22K	5%	1/4W	R109	1-216-829-11	RES-CHIP	4.7K	5%	1/10W
R054	1-249-433-11	CARBON	22K	5%	1/4W	R110	1-249-409-11	CARBON	220	5%	1/4W
R055	1-216-829-11	RES-CHIP	4.7K	5%	1/10W	R111	1-216-829-11	RES-CHIP	4.7K	5%	1/10W
R056	1-216-833-11	RES-CHIP	10K	5%	1/10W	R112	1-249-425-11	CARBON	4.7K	5%	1/4W
R057	1-249-417-11	CARBON	1K	5%	1/4W	R115	1-216-817-11	RES-CHIP	470	5%	1/10W
R058	1-249-429-11	CARBON	10K	5%	1/4W	R116	1-216-853-11	RES-CHIP	470K	5%	1/10W
R059	1-249-417-11	CARBON	1K	5%	1/4W	R200	1-216-841-11	RES-CHIP	47K	5%	1/10W
R060	1-249-409-11	CARBON	220	5%	1/4W	R202	1-216-845-11	RES-CHIP	100K	5%	1/10W
						R203	1-216-845-11	RES-CHIP	100K	5%	1/10W













REF. NO.	PART NO.	DESCRIPTION	VALUES			REF. NO.	PART NO.	DESCRIPTION	VALUES		
R204	1-249-437-11	CARBON	47K	5%	1/4W	R394	1-216-833-11	RES-CHIP	10K	5%	1/10W
R205	1-216-841-11	RES-CHIP	47K	5%	1/10W	R402	1-216-864-11	SHORT CHIP	0		
R206	1-216-845-11	RES-CHIP	100K	5%	1/10W	R406	1-216-813-11	RES-CHIP	220	5%	1/10W
R207	1-216-845-11	RES-CHIP	100K	5%	1/10W	R407	1-216-813-11	RES-CHIP	220	5%	1/10W
R208	1-249-437-11	CARBON	47K	5%	1/4W	R410	1-216-864-11	SHORT CHIP	0		
R209	1-249-437-11	CARBON	47K	5%	1/4W	R413	1-216-864-11	SHORT CHIP	0		
R210	1-216-845-11	RES-CHIP	100K	5%	1/10W	R415	1-216-864-11	SHORT CHIP	0		
R211	1-249-437-11	CARBON	47K	5%	1/4W	R416	1-216-864-11	SHORT CHIP	0		
R212	1-249-437-11	CARBON	47K	5%	1/4W	R435	1-216-833-11	RES-CHIP	10K	5%	1/10W
R213	1-216-845-11	RES-CHIP	100K	5%	1/10W	R436	1-216-864-11	SHORT CHIP	0		
R220	1-216-841-11	RES-CHIP	47K	5%	1/10W	R437	1-216-829-11	RES-CHIP	4.7K	5%	1/10W
R226	1-218-285-11	RES-CHIP	75	5%	1/10W	R438	1-249-417-11	CARBON	1K	5%	1/4W
R250	1-216-864-11	SHORT CHIP	0			R440	1-249-409-11	CARBON	220	5%	1/4W
R251	1-216-864-11	SHORT CHIP	0			R441	1-249-409-11	CARBON	220	5%	1/4W
R303	1-218-285-11	RES-CHIP	75	5%	1/10W	R450	1-249-425-11	CARBON	4.7K	5%	1/4W
R305	1-218-285-11	RES-CHIP	75	5%	1/10W	R455	1-216-821-11	RES-CHIP	1K	5%	1/10W
R306	1-218-285-11	RES-CHIP	75	5%	1/10W	R456	1-216-821-11	RES-CHIP	1K	5%	1/10W
R307	1-218-285-11	RES-CHIP	75	5%	1/10W	R457	1-216-821-11	RES-CHIP	1K	5%	1/10W
R311	1-216-813-11	RES-CHIP	220	5%	1/10W	R458	1-216-821-11	RES-CHIP	1K	5%	1/10W
R312	1-218-867-11	RES-CHIP	6.8K	5%	1/10W	R459	1-216-817-11	RES-CHIP	470	5%	1/10W
R313	1-216-864-11	SHORT CHIP	0			R460	1-216-817-11	RES-CHIP	470	5%	1/10W
R314	1-216-833-11	RES-CHIP	10K	5%	1/10W	R461	1-216-821-11	RES-CHIP	1K	5%	1/10W
R315	1-216-813-11	RES-CHIP	220	5%	1/10W	R462	1-216-821-11	RES-CHIP	1K	5%	1/10W
R316	1-216-825-11	RES-CHIP	2.2K	5%	1/10W	R463	1-249-437-11	CARBON	47K	5%	1/4W
R317	1-216-813-11	RES-CHIP	220	5%	1/10W	R464	1-216-841-11	RES-CHIP	47K	5%	1/10W
R318	1-216-825-11	RES-CHIP	2.2K	5%	1/10W	R477	1-216-819-11	RES-CHIP	680	5%	1/10W
R319	1-216-813-11	RES-CHIP	220	5%	1/10W	R478	1-216-833-11	RES-CHIP	10K	5%	1/10W
R320	1-216-825-11	RES-CHIP	2.2K	5%	1/10W	R479	1-216-821-11	RES-CHIP	1K	5%	1/10W
R321	1-247-807-31	CARBON	100	5%	1/4W	R484	1-216-809-11	RES-CHIP	100	5%	1/10W
R322	1-216-817-11	RES-CHIP	470	5%	1/10W	R485	1-216-809-11	RES-CHIP	100	5%	1/10W
R323	1-249-414-11	CARBON	560	5%	1/4W	R487	1-216-837-11	RES-CHIP	22K	5%	1/10W
R324	1-216-826-11	RES-CHIP	2.7K	5%	1/10W	R488	1-216-837-11	RES-CHIP	22K	5%	1/10W
R337	1-216-801-11	RES-CHIP	22	5%	1/10W	R489	1-216-825-11	RES-CHIP	2.2K	5%	1/10W
R351	1-216-833-11	RES-CHIP	10K	5%	1/10W	R490	1-216-825-11	RES-CHIP	2.2K	5%	1/10W
R352	1-216-853-11	RES-CHIP	470K	5%	1/10W	R494	1-216-833-11	RES-CHIP	10K	5%	1/10W
R360	1-216-809-11	RES-CHIP	100	5%	1/10W	R498	1-216-864-11	SHORT CHIP	0		
R361	1-216-809-11	RES-CHIP	100	5%	1/10W	R499	1-218-700-11	METAL CHIP	2.2K	0.50%	1/16W
R370	1-216-825-11	RES-CHIP	2.2K	5%	1/10W	R502	1-249-425-11	CARBON	4.7K	5%	1/4W
R371	1-216-857-11	RES-CHIP	1M	5%	1/10W	R503	1-215-923-00	METAL OXIDE	10K	5%	3W
R372	1-216-827-11	RES-CHIP	3.3K	5%	1/10W	R504	1-102-212-00	CERAMIC	820pF	10%	500V
R390	1-216-864-11	SHORT CHIP	0			R507	1-216-833-11	RES-CHIP	10K	5%	1/10W
R391	1-216-829-11	RES-CHIP	4.7K	5%	1/10W	R510	1-260-320-11	CARBON	220	5%	1/2W
R392	1-216-818-11	RES-CHIP	560	5%	1/10W	R512	1-215-910-00	METAL OXIDE	68	5%	3W
R393	1-216-825-11	RES-CHIP	2.2K	5%	1/10W	R513	1-215-913-11	METAL OXIDE	220	5%	3W



NOTE: The components identified by shading and  mark are critical for safety. Replace only with part number specified.



NOTE: Les composants identifiés par un trame et une marque  sont critiques pour la sécurité. Ne les remplacer que par une pièce portant le numéro spécifique.



REF. NO.	PART NO.	DESCRIPTION	VALUES			REF. NO.	PART NO.	DESCRIPTION	VALUES		
R627	1-215-481-00	METAL	330K	1%	1/4W						
R628	1-260-131-11	CARBON	470K	5%	1/2W						
R629	1-215-481-00	METAL	330K	1%	1/4W						
R630	1-215-481-00	METAL	330K	1%	1/4W						
R631	1-218-716-11	METAL CHIP	10K	0.50%	1/16W						
R632	1-216-809-11	RES-CHIP	100	5%	1/10W						
R634	1-215-907-11	METAL OXIDE	22	5%	3W						
R640	1-249-417-11	CARBON	1K	5%	1/4W						
R647	1-216-811-11	RES-CHIP	150	5%	1/10W						
R650	1-249-415-11	CARBON	680	5%	1/4W						
R658	1-249-393-11	CARBON	10	5%	1/4W						
R659	1-249-393-11	CARBON	10	5%	1/4W						
R660	1-216-833-11	RES-CHIP	10K	5%	1/10W						
R667	1-216-833-11	RES-CHIP	10K	5%	1/10W						
 R668	1-249-418-11	CARBON	1.2K	5%	1/4W						
R670	1-216-833-11	RES-CHIP	10K	5%	1/10W						
R671	1-243-979-71	METAL OXIDE	0.1	5%	2W						
R680	1-216-864-11	SHORT CHIP	0								
R687	1-202-961-11	RES, CEMENT	1.8	5%	10W						
		(FOR KV-13FS100/13FS110/14FV300N ONLY)									
R687	1-244-206-11	WIREWOUND	2.2	5%	10W						
		(FOR KV-14FV300S ONLY)									
 R699	1-218-265-11	METAL	8.2M	5%	1W						
		(FOR KV-14FV300S ONLY)									
R850	1-215-451-00	METAL	18K	1%	1/4W						
R851	1-216-821-11	RES-CHIP	1K	5%	1/10W						
R852	1-218-714-11	METAL CHIP	8.2K	0.50%	1/16W						
R862	1-216-813-11	RES-CHIP	220	5%	1/10W						
		<b>RELAY</b>									
RY501	1-755-198-11	RELAY									
 RY600	1-755-395-11	RELAY (AC POWER)									
		<b>SWITCH</b>									
S002	1-692-431-21	SWITCH TACTILE									
S003	1-692-431-21	SWITCH TACTILE									
S004	1-692-431-21	SWITCH TACTILE									
S005	1-692-431-21	SWITCH TACTILE									
S006	1-692-431-21	SWITCH TACTILE									
S007	1-762-816-11	SWITCH TACTILE									
S008	1-762-816-11	SWITCH TACTILE									
		<b>SWITCH</b>									
SW515	1-572-707-11	SWITCH LEVER									
		<b>TRANSFORMER</b>									
 T505	1-433-836-11	TRANSFORMER, HORIZONTAL DRIVE (FOR KV-13FS100/13FS110/14FV300N ONLY)									
 T585	1-453-339-11	FBT ASSY NX-1912//M3E4									
 T601	1-426-717-11	TRANSFORMER, LINE FILTER (LFT) (FOR KV-14FV300S ONLY)									
 T601	1-435-617-11	TRANSFORMER, LINE FILTER (FOR KV-13FS100/13FS110/14FV300N ONLY)									
 T602	1-435-675-11	TRANSFORMER, STANDBY (FOR KV-13FS100/13FS110/14FV300N ONLY)									
 T602	1-435-676-11	TRANSFORMER, STANDBY (FOR KV-14FV300S ONLY)									
 T603	1-437-609-11	CONVERTER TRANSFORMER									
		<b>THERMISTOR</b>									
THP501	1-803-539-11	THERMISTOR (FOR KV-13FS100/13FS110/14FV300N ONLY)									
THP501	1-803-540-11	THERMISTOR (FOR KV-14FV300S ONLY)									
		<b>TUNER</b>									
 TU101	8-598-593-30	TUNER, FSS BTF-WA421									
		<b>VARISTOR</b>									
VDR600	1-803-585-11	VARISTOR (ENE271D-10A) (FOR KV-13FS100/13FS110/14FV300N ONLY)									
VDR600	1-803-967-11	VARISTOR (ENE621D-14A) (FOR KV-14FV300S ONLY)									
		<b>CRYSTAL</b>									
X001	1-795-006-21	OSCILLATOR, CRYSTAL									
X301	1-781-377-11	VIBRATOR, CRYSTAL									
		<b>M</b>									
*	<b>A-1401-047-A</b>	<b>M (VAR) BOARD, MOUNTED</b>									
		<b>CAPACITOR</b>									
C10	1-126-947-11	ELECT	47µF	20%	25V						
C11	1-162-970-11	CERAMIC CHIP	0.01µF	10%	25V						
C12	1-163-275-11	CERAMIC CHIP	0.001µF	5%	50V						
C13	1-162-970-11	CERAMIC CHIP	0.01µF	10%	25V						
C14	1-163-275-11	CERAMIC CHIP	0.001µF	5%	50V						





REF. NO.	PART NO.	DESCRIPTION	VALUES	REF. NO.	PART NO.	DESCRIPTION	VALUES
C50	1-126-959-11	ELECT	0.47µF 20% 50V	R56	1-216-823-11	RES-CHIP	1.5K 5% 1/10W
C51	1-126-935-11	ELECT	470µF 20% 16V	R57	1-216-864-11	SHORT CHIP	0
C70	1-126-947-11	ELECT	47µF 20% 25V	R58	1-216-835-11	RES-CHIP	15K 5% 1/10W
C71	1-162-970-11	CERAMIC CHIP	0.01µF 10% 25V	R59	1-216-065-91	RES-CHIP	4.7K 5% 1/10W
C72	1-164-227-11	CERAMIC CHIP	0.022µF 10% 25V	R70	1-218-716-11	METAL CHIP	10K 0.50% 1/16W
C80	1-126-947-11	ELECT	47µF 20% 25V	R71	1-218-716-11	METAL CHIP	10K 0.50% 1/16W
<b>CONNECTOR</b>				R72	1-218-700-11	METAL CHIP	2.2K 0.50% 1/16W
* CN10	1-816-567-11	HEADER ASSY FOR PRINTED BOARD 6P		R73	1-216-839-11	RES-CHIP	33K 5% 1/10W
<b>DIODE</b>				R77	1-218-740-11	METAL CHIP	100K 0.50% 1/16W
D50	8-719-404-50	DIODE MA111-TX		R78	1-208-814-91	METAL CHIP	22K 0.50% 1/10W
<b>IC</b>				R79	1-208-798-11	METAL CHIP	4.7K 0.50% 1/10W
IC1	8-759-700-07	IC NJM2903M-TE2		 * <b>A-1400-251-A HR (COM) BOARD, MOUNTED</b>			
IC2	8-759-700-07	IC NJM2903M-TE2					
IC3	8-759-701-01	IC NJM2904M(TE2)		<b>CAPACITOR</b>			
<b>CHIP CONDUCTOR</b>				C3001	1-104-665-11	ELECT	100µF 20% 25V
JR1	1-216-864-11	SHORT CHIP	0	<b>CONNECTOR</b>			
JR2	1-216-864-11	SHORT CHIP	0	CN3001	1-564-521-11	PLUG,CONNECTOR	6P
JR6	1-216-864-11	SHORT CHIP	0	<b>DIODE</b>			
JR7	1-216-864-11	SHORT CHIP	0	D3002	8-719-057-09	DIODE LNJ801LPDJA	
JR12	1-216-864-11	SHORT CHIP	0	<b>IC</b>			
JR44	1-216-864-11	SHORT CHIP	0	IC3001	8-742-211-20	HYB IC SBX3071-71	
<b>COIL</b>				<b>RESISTOR</b>			
L50	1-408-615-31	INDUCTOR	100µH	R3001	1-249-417-11	CARBON	1K 5% 1/4W
<b>TRANSISTOR</b>				R3014	1-247-807-31	CARBON	100 5% 1/4W
Q50	8-729-422-27	TRANSISTOR 2SD601A-QRS-TX		<b>SWITCH</b>			
Q51	8-729-422-27	TRANSISTOR 2SD601A-QRS-TX		S3006	1-572-198-11	SWITCH KEYBOARD	
Q52	8-729-422-27	TRANSISTOR 2SD601A-QRS-TX		 * <b>A-1401-049-A C BOARD, MOUNTED</b>			
<b>RESISTOR</b>							
R10	1-208-798-11	METAL CHIP	4.7K 0.50% 1/10W	<b>CAPACITOR</b>			
R11	1-208-798-11	METAL CHIP	4.7K 0.50% 1/10W	C780	1-162-926-11	CERAMIC CHIP	82pF 5% 50V
R12	1-218-692-11	METAL CHIP	1K 0.50% 1/16W	C781	1-162-926-11	CERAMIC CHIP	82pF 5% 50V
R13	1-208-798-11	METAL CHIP	4.7K 0.50% 1/10W	C782	1-162-926-11	CERAMIC CHIP	82pF 5% 50V
R50	1-216-829-11	RES-CHIP	4.7K 5% 1/10W	C1752	1-162-114-00	CERAMIC	0.0047µF 2KV
R51	1-216-833-11	RES-CHIP	10K 5% 1/10W	C1753	1-137-528-11	MYLAR	0.1µF 10% 250V
R52	1-216-833-11	RES-CHIP	10K 5% 1/10W				
R53	1-216-829-11	RES-CHIP	4.7K 5% 1/10W				
R54	1-216-829-11	RES-CHIP	4.7K 5% 1/10W				
R55	1-216-065-91	RES-CHIP	4.7K 5% 1/10W				







REF. NO.	PART NO.	DESCRIPTION	VALUES			REF. NO.	PART NO.	DESCRIPTION	VALUES
R1767	1-247-807-31	CARBON	100	5%	1/4W				
R1768	1-247-807-31	CARBON	100	5%	1/4W				
R1770	1-260-132-11	CARBON	560K	5%	1/2W				
R1778	1-216-833-11	RES-CHIP	10K	5%	1/10W				
R1780	1-216-837-11	RES-CHIP	22K	5%	1/10W				
R1781	1-216-838-11	RES-CHIP	27K	5%	1/10W				
R1787	1-216-837-11	RES-CHIP	22K	5%	1/10W				
<b><u>VARIABLE RESISTOR</u></b>									
RV1750	1-241-656-11	RES, ADJ, METAL FILM	110M						
<b><u>ACCESSORIES AND PACKING</u></b>									
	4-041-254-01	BAG, PROTECTION							
	4-086-340-22	MANUAL, INSTRUCTION (ENGLISH) (FOR KV-13FS100/13FS110 ONLY)							
	4-086-340-32	MANUAL, INSTRUCTION (FRENCH) (FOR KV-13FS100(CND)/13FS110(CND) ONLY)							
	4-086-341-42	MANUAL, INSTRUCTION (SPANISH) (FOR KV-14FV300 ONLY)							
*	4-088-941-01	INDIVIDUAL CARTON							
*	4-088-942-01	CUSHION (UPPER)							
*	4-088-943-01	CUSHION (LOWER)							
	1-417-182-11	CONVERTER (EAC-25) (FOR KV-14FV300 ONLY)							
	1-501-730-41	ANTENNA, TELESCOPIC (FOR KV-14FV300 ONLY)							
<b><u>REMOTE COMMANDER</u></b>									
	1-477-119-22	REMOTE COMMANDER (RM-Y173) (SILVER) (FOR KV-13FS100/14FV300 ONLY)							
	1-477-174-22	REMOTE COMMANDER (RM-Y173) (WHITE) (FOR KV-13FS110 ONLY)							
	3-709-322-31	BATTERY COVER (FOR RM-Y173) (SILVER) (FOR KV-13FS100/14FV300 ONLY)							
	3-709-322-21	BATTERY COVER (FOR RM-Y173) (WHITE) (FOR KV-13FS110 ONLY)							

*In an effort to reduce the size of this pdf file the tiled schematics are not attached to this Service Manual. To receive a complete set of the tiled schematics for this manual please submit a request to Nita Wardlaw at [nita.wardlaw@am.sony.com](mailto:nita.wardlaw@am.sony.com).*



**FD Trinitron**  
**WEGA**<sup>®</sup>

---

Operating Instructions

KV-13FS100  
KV-13FS110  
KV-20FS100  
KV-24FS100



# WARNING

To reduce the risk of fire or electric shock, do not expose the TV to rain or moisture.



This symbol is intended to alert the user to the presence of uninsulated “dangerous voltage” within the product’s enclosure that may be of sufficient magnitude to constitute a risk of electric shock to persons.



This symbol is intended to alert the user to the presence of important operating and maintenance (servicing) instructions in the literature accompanying the appliance.

## Note to the CATV Installer

This reminder is provided to call the CATV system installer’s attention to Article 820-40 of the NEC that provides guidelines for proper grounding and, in particular, specifies that the cable ground shall be connected to the grounding system of the building as close to the point of cable entry as practical.

## SAFETY PRECAUTIONS

- ❑ Operate the TV only on 120 V AC.
- ❑ One blade of the power plug is wider than the other for safety purposes and will fit into the power outlet only one way. If you are unable to insert the plug fully into the outlet, contact your dealer.
- ❑ If any liquid or solid object falls into the TV, unplug it and have it checked by qualified personnel before operating it further.

## CAUTION

When using TV games, computers, and similar products with your TV, keep the brightness and contrast functions at low settings. If a fixed (non-moving) pattern is left on the screen for long periods of time at a high brightness or contrast setting, the image can be permanently imprinted onto the screen. Continuously watching the same channel can cause the imprint of station logos onto the TV screen. These types of imprints are not covered by your warranty because they are the results of misuse.



**To reduce the risk of electric shock, do not use this polarized plug with an extension cord, receptacle, or other outlet unless the blades can be fully inserted to prevent blade exposure.**

 You are cautioned that any changes or modifications not expressly approved in this manual could void your authority to operate this equipment.

## NOTIFICATION

This equipment has been tested and found to comply with the limits for a Class B digital device pursuant to Part 15 of the FCC Rules. These limits are designed to provide reasonable protection against harmful interference in a residential installation. This equipment generates, uses, and can radiate radio frequency energy and, if not installed and used in accordance with the instructions, may cause harmful interference with radio communications. However, there is no guarantee that interference will not occur in a particular installation. If this equipment does cause harmful interference to radio or television reception, which can be determined by turning the equipment off and on, the user is encouraged to try to correct the interference by one or more of the following measures:

- Reorient or relocate the receiving antennas.
- Increase the separation between the equipment and receiver.
- Connect the equipment into an outlet on a circuit different from that to which the receiver is connected.
- Consult the dealer or an experienced radio/TV technician for help.

## Protecting the TV

- To prevent internal heat build-up, do not block the ventilation openings.
- Do not install the TV in a hot or humid place, or in a place subject to excessive dust or mechanical vibration.

## Note on Caption Vision

This television receiver provides display of television closed captioning in accordance with § 15.119 of the FCC rules.

Use of this television for other than private viewing of programs broadcast on UHF or VHF or transmitted by cable companies for the use of the general public may require authorization from the broadcaster-cable company and/or program owner.

## Owner's Record

The model and serial numbers are located on the front cover of this manual and at the rear of your TV.

## Trademarks and Copyrights

ENERGY STAR<sup>®</sup> is a registered mark.



As an ENERGY STAR<sup>®</sup> Partner, Sony has determined that this product or product model meets the ENERGY STAR<sup>®</sup> guidelines for energy efficiency.



# IMPORTANT SAFEGUARDS

For your protection, please read these instructions completely, and keep this manual for future reference. Carefully observe and comply with all warnings, cautions and instructions placed on the set, or described in the operating instructions or service manual.

## WARNING

To guard against injury, the following basic safety precautions should be observed in the installation, use, and servicing of the set.

## Use

### Power Sources

This set should be operated only from the type of power source indicated on the serial/model plate. If you are not sure of the type of electrical power supplied to your home, consult your dealer or local power company. For those sets designed to operate from battery power, refer to the operating instructions.



### Grounding or Polarization

This set is equipped with a polarized AC power cord plug (a plug having one blade wider than the other), or with a three-wire grounding type plug (a plug having a third pin for grounding).

Refer to the following instructions:

### For the set with a polarized AC power cord plug

This plug will fit into the power outlet only one way. This is a safety feature. If you are unable to insert the plug fully into the outlet, try reversing the plug. If the plug still fails to fit, contact your electrician to have a suitable outlet installed. Do not defeat the safety purpose of the polarized plug by forcing it in.



### Alternate Warning

### For the set with a three-wire grounding type AC plug

This plug will only fit into a grounding-type power outlet. This is a safety feature. If you are unable to insert the plug into the outlet, contact your electrician to have a suitable outlet installed. Do not defeat the safety purpose of the grounding plug.

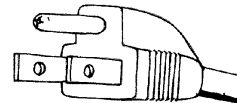

## Overloading

Do not overload wall outlets, extension cords or convenience receptacles beyond their capacity, since this can result in fire or electric shock. Always turn the set off when it is not to be used. When the set is left unattended and unused for long periods of time, unplug it from the wall outlet as a precaution against the possibility of an internal malfunction that could create a fire hazard.

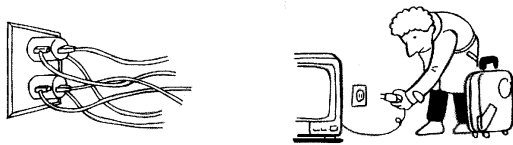

Do not disconnect the antenna or the power cord during a heavy storm. Lightning may strike while you are holding the cable or cord, causing serious injury. Turn off your TV and wait for the weather to improve.

## Object and Liquid Entry

Never push objects of any kind into the set through the cabinet slots as they may touch dangerous voltage points or short out parts that could result in a fire or electric shock. Never spill liquid of any kind on the set.



## Attachments

Do not use attachments not recommended by the manufacturer, as they may cause hazards.

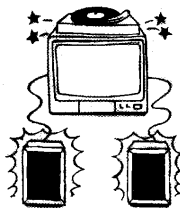

Do not place any objects, especially heavy objects, on top of the set. The object may fall from the set, causing injury.

## Cleaning

Unplug the set from the wall outlet before cleaning or polishing it. Do not use liquid cleaners or aerosol cleaners. Use a cloth lightly dampened with water for cleaning the exterior of the set.

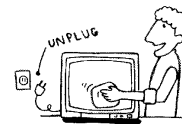

If a snapping or popping sound from a TV set is continuous or frequent while the TV is operating, unplug the TV and consult your dealer or service technician. It is normal for some TV sets to make occasional snapping or popping sounds, particularly when being turned on or off.

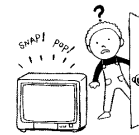

## Installation

Always use two or more people to lift or move the set. The set is heavy and the bottom surface is flat. Serious injury can result from trying to move the set by yourself alone, or from unsteady handling. Install the set on a stable, level surface.

## Water and Moisture

Do not use power-line operated sets near water — for example, near a bathtub, washbowl, kitchen sink, or laundry tub, in a wet basement, or near a swimming pool, etc.

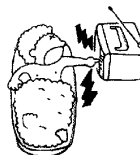

## Accessories

Do not place the set on an unstable cart, stand, tripod, bracket, table, or shelf. The set may fall, causing serious injury to a child or an adult, and serious damage to the set. Use only a cart or stand recommended by the manufacturer for the specific model of TV. Any mounting of the product should follow the manufacturer's instructions, and should use a mounting accessory recommended by the manufacturer. An appliance and cart combination should be moved with care. Quick stops, excessive force, and uneven surfaces may cause the appliance and cart combination to overturn.

Disconnect all cables and cords from the set before attempting to move the set.



Do not allow children or pets to climb up onto, or push against, the set. The set may fall, causing serious injury.

## Ventilation

The slots and openings in the cabinet and in the back or bottom are provided for necessary ventilation. To ensure reliable operation of the set, and to protect it from overheating, these slots and openings must never be blocked or covered.

- **Never cover the slots and openings with a cloth or other materials.**

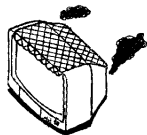

- **Never block the slots and openings by placing the set on a bed, sofa, rug or other similar surface.**

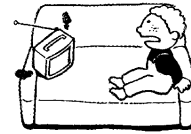

- **Never place the set in a confined space, such as a bookcase or built-in cabinet, unless proper ventilation is provided.**

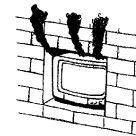

- **Do not place the set near or over a radiator or heat register, or where it is exposed to direct sunlight.**



## Power-Cord Protection

Do not allow anything to rest on or roll over the power cord, and do not place the set where the power cord is subject to wear or abuse.

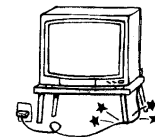

## Grounding or Polarization

This set may be equipped with a polarized alternating current line plug (a plug having one blade wider than other). This plug will fit into the power outlet only one way. This is a safety feature. If you are unable to insert the plug fully into the outlet, try reversing the plug. If the plug still fails to fit, contact your electrician to replace your obsolete outlet. Do not defeat the safety purpose of the polarized plug.

## Antennas

### Outdoor Antenna Grounding

If an outdoor antenna is installed, follow the precautions below. An outdoor antenna system should not be located in the vicinity of overhead power lines or other electric light or power circuits, or where it can come in contact with such power lines or circuits.

WHEN INSTALLING AN OUTDOOR ANTENNA SYSTEM, EXTREME CARE SHOULD BE TAKEN TO KEEP FROM CONTACTING SUCH POWER LINES OR CIRCUITS AS CONTACT WITH THEM IS ALMOST INVARIABLY FATAL.

Be sure the antenna system is grounded so as to provide some protection against voltage surges and built-up static charges. Section 810 of the National Electrical Code (NEC) in USA and Section 54 of the Canadian Electrical Code in Canada provides information with respect to proper grounding of the mast and supporting structure, grounding of the lead-in wire to an antenna discharge unit, size of grounding conductors, location of antenna discharge unit, connection to grounding electrodes, and requirements for the grounding electrode.

### Antenna Grounding According to the NEC

Antenna Grounding According to the National Electrical Code, ANSI/NFPA 70.

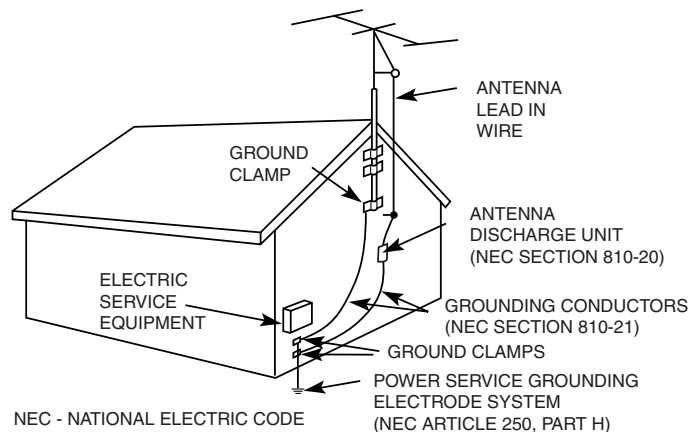

## Lightning

For added protection for this television receiver during a lightning storm, or when it is left unattended and unused for long periods of time, unplug it from the wall outlet and disconnect the antenna. This will prevent damage to the receiver due to lightning and power-line surges.

## Service

### Damage Requiring Service

Unplug the set from the wall outlet and refer servicing to qualified service personnel under the following conditions:

- When the power cord or plug is damaged or frayed.

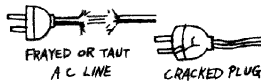

- If liquid has been spilled into the set or objects have fallen into the product.

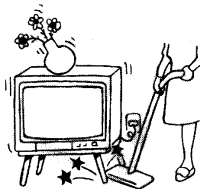

- If the set has been exposed to rain or water.



- If the set has been subject to excessive shock by being dropped, or the cabinet has been damaged.

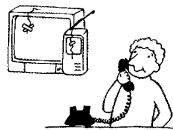

- If the set does not operate normally when following the operating instructions. Adjust only those controls that are specified in the operating instructions. Improper adjustment of other controls may result in damage and will often require extensive work by a qualified technician to restore the set to normal operation.



- When the set exhibits a distinct change in performance — this indicates a need for service.

### Servicing

Do not attempt to service the set yourself since opening the cabinet may expose you to dangerous voltage or other hazards. Refer all servicing to qualified service personnel.



### Replacement Parts

When replacement parts are required, be sure the service technician certifies in writing that he has used replacement parts specified by the manufacturer that have the same characteristics as the original parts. Unauthorized substitutions may result in fire, electric shock, or other hazards.



### Safety Check

Upon completion of any service or repairs to the set, ask the service technician to perform routine safety checks (as specified by the manufacturer) to determine that the set is in safe operating condition, and to so certify. When the set reaches the end of its useful life, improper disposal could result in a picture tube implosion. Ask a qualified service technician to dispose of the set.





# Contents

## Introduction

Introducing the FD Trinitron WEGA® Features.....	1
Batteries for the Remote Control .....	2
About this Manual .....	2
Front Panel Menu Controls .....	2







## Connecting Your TV

TV Rear Panel .....	3
Basic Connections .....	4
Connecting Additional Equipment .....	5

## Using the Remote Control and Basic Functions

Using the Remote Control .....	12
Setting Up the TV Automatically .....	14
Quick Start to the Menus .....	15

## Using the Menus

To Access a Menu.....	17
Using the Video  Menu .....	18
Using the Audio  Menu .....	19
Using the Channel Setup  Menu.....	20
Parental Control .....	22
Using the Parental Control  Menu .....	25
Using the Timer  Menu.....	28
Using the Setup  Menu.....	29

## Other Information

Troubleshooting .....	31
Specifications .....	33

<b>Index</b> .....	<b>35</b>
--------------------	-----------





# Introduction

Congratulations on your purchase of the Sony FD Trinitron WEGA<sup>®</sup>. Before you begin using this manual, please check the model number located on the rear of your TV or on the front cover of this manual.

## Introducing the FD Trinitron WEGA<sup>®</sup> Features

Some of the features you will enjoy include:

- ❑ **FD Trinitron FLAT CRT** — Technologically advanced tube delivers a picture with uncompromising accuracy and outstanding image detail.
- ❑ **Y, Pb, Pr Inputs** — A component video input connection for a superior picture quality.
- ❑ **Parental Control (V-Chip)** — A tool to help parents monitor what their children watch on TV by establishing rating limits.
- ❑ **Favorite Channels** — Instant access to your favorite channels with the touch of a button.
- ❑ **Energy Star<sup>®</sup>** — A recognized symbol of energy efficiency.
- ❑ **Direct MTS** — Allows direct access for changing your Multi-Channel TV Sound: Stereo, Mono, or Auto SAP (Second Audio Program) with the touch of a button.
- ❑ **Trilingual Menus** — Choose between English, French, or Spanish menus.
- ❑ **Front Panel Controls** — Allows access to the on-screen menus without the use of a remote control.
- ❑ **Front A/V Inputs** — A quick connection for video games, camcorders, stereo/mono equipment, or headphones.
- ❑ **Auto Mute** — A friendly feature designed to automatically mute your TV when no signal is received.

# Batteries for the Remote Control

Insert two AA (R6) batteries (supplied) into the remote control using the following illustration as a guide.

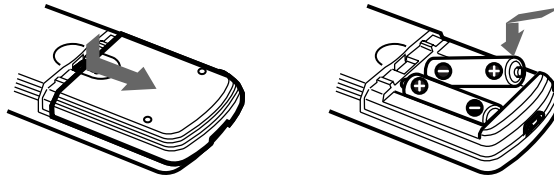

 Under normal conditions, batteries will last up to six months. If the remote control does not operate properly, the batteries might be worn out.

 If you will not be using the remote control for an extended period of time, remove the batteries to avoid possible damage from battery leakage.









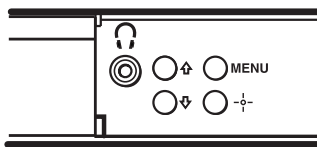

## About this Manual

This manual provides instructions to help you enjoy your new TV. It shows you how to connect to an antenna or cable, cable box, VCR, DVD, satellite receiver, stereo system, or camcorder. Once you're connected, follow the instructions and use the remote control to access the on-screen menus.

 The TV front and rear panels illustrated in this manual are for KV-24FS100. The front and rear panels on your TV may not look exactly like those illustrated.

## Front Panel Menu Controls



The front Audio/Video panel controls allows you to access the menu without the remote control. Press  to display the on-screen menu. Use the  and  buttons on the front Audio/Video panel instead of the  and  buttons on the remote control. Use the  button on the front Audio/Video panel instead of the , , and  buttons on the remote control. Press  again when the setting or adjustment is complete.

 To navigate the menus with your remote control, see "Using the Menus" on page 17.

# Connecting Your TV

Read this section before setting up your TV for the first time. This section covers basic connections in addition to any optional equipment you may be connecting.

## TV Rear Panel

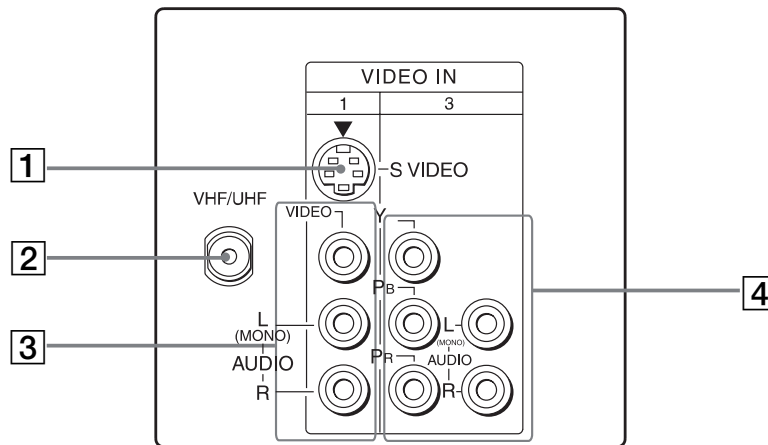

Jack	Description
<b>1 S VIDEO</b>	Connects to the S VIDEO OUT jack on your VCR or other video equipment that has S VIDEO. S VIDEO provides better picture quality than the VHF/UHF jacks or the video input jack. S VIDEO does not provide sound; the audio cables must still be connected.
<b>2 VHF/UHF</b>	Connects to your VHF/UHF antenna or cable.
<b>3 VIDEO/ AUDIO (L/R)</b>	Connects to the AUDIO and VIDEO output jacks on your VCR or other video equipment. A second video input jack (VIDEO 2) is located on the front panel of the TV. These AUDIO/VIDEO input jacks provide better picture quality than the VHF/UHF jack.
<b>4 Y, P<sub>B</sub>, P<sub>R</sub>/ L, R</b>	Connects to the component video Y, P <sub>B</sub> , P <sub>R</sub> to AUDIO L and R output jacks on your DVD player or Digital Set-top box.

 The rear panels illustrated in this manual are for KV-24FS100. The rear panels on your TV may not look exactly like those illustrated.

## Basic Connections

### TV with indoor or outdoor antenna, or CATV cable

Depending on the cable available in your home, choose one of the connections below:

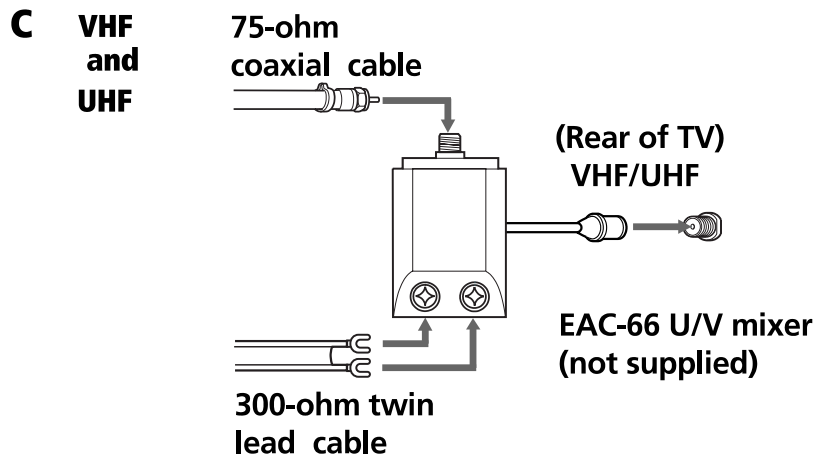
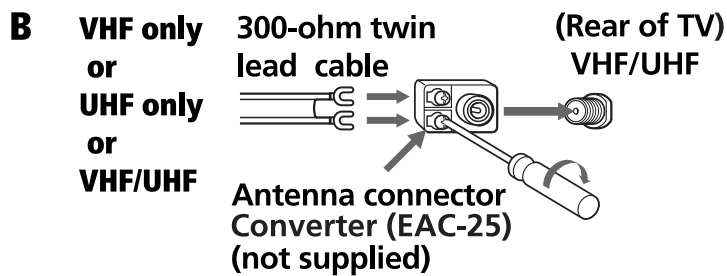
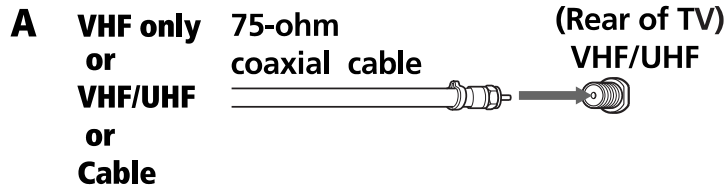

 If you are connecting to an indoor or outdoor antenna, you may need to adjust the orientation of the antenna for best reception.

# Connecting Additional Equipment

## TV and VCR

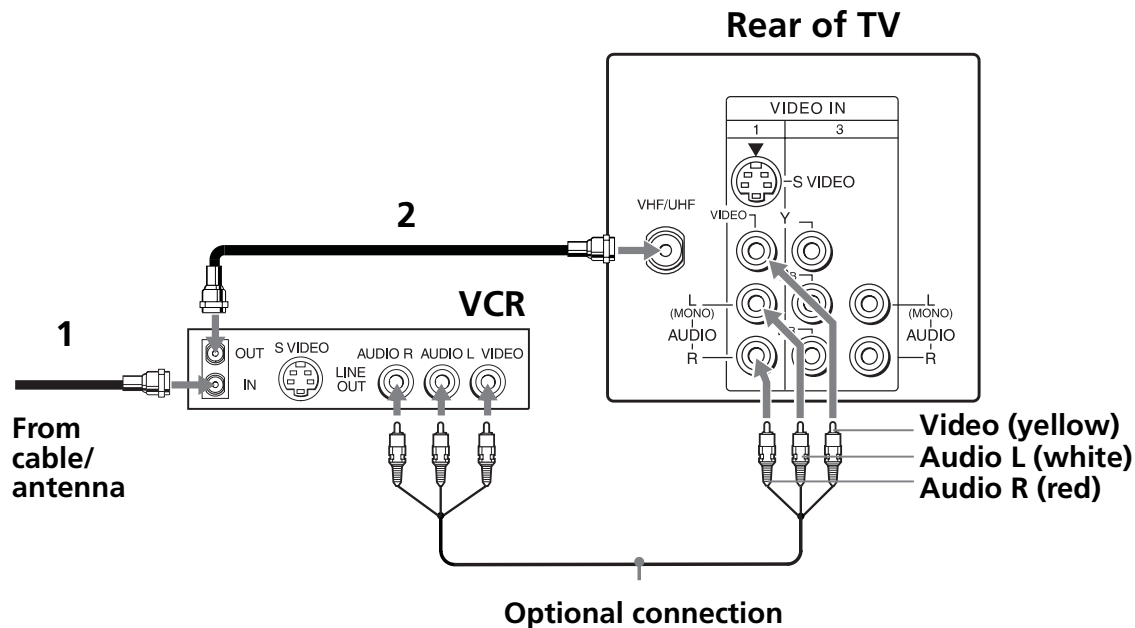

To watch video programs from your VCR, tune your TV to channel 3 or 4 (as set on the rear of your VCR).

- 1** Connect the coaxial cable from your TV antenna or cable service to the IN jack on your VCR.
- 2** Connect a coaxial cable (not supplied) from the OUT jack on your VCR to the VHF/UHF jack on the TV.

### Optional connection

If your VCR is equipped with video outputs, you can get better picture quality by connecting Audio/Video cables (not supplied) from AUDIO and VIDEO OUT on your VCR to AUDIO/VIDEO IN on your TV.

You can use the button to switch between the VHF/UHF and VIDEO inputs.

For better picture quality, use S VIDEO instead of the yellow Audio/Video cable. S VIDEO does not provide sound; the audio cables must still be connected.

## TV and Cable Box

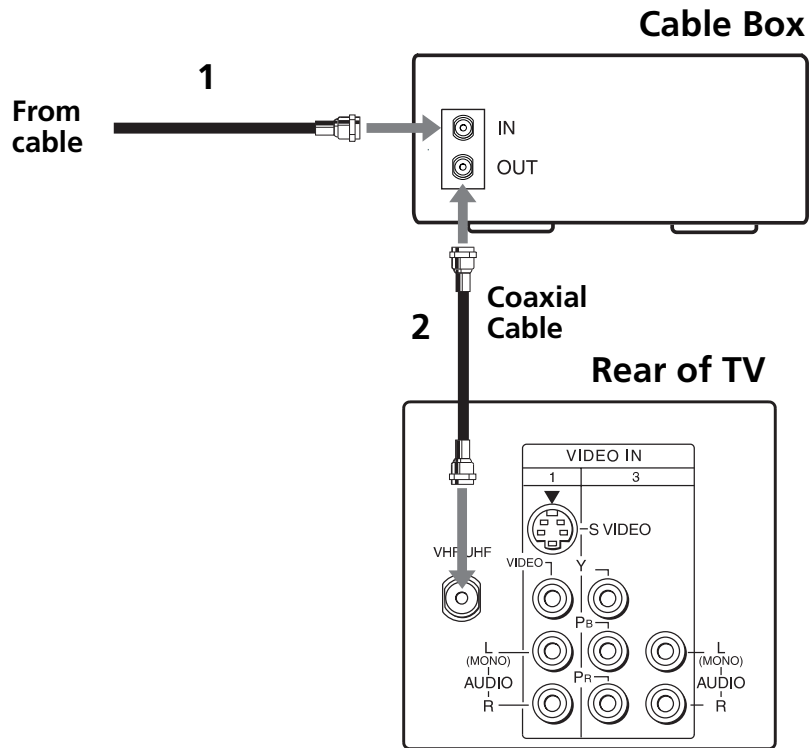

- 1** Connect the coaxial cable from your cable service to the IN jack on your cable box.
- 2** Connect a coaxial cable (not supplied) from the OUT jack on your cable box to the VHF/UHF jack on the TV.

 To view channels from your cable box, tune your TV to channel 3 or 4 (as set on the rear panel of your cable box) and use the cable box's remote control to change channels.

 If you will be controlling all channel selection through your cable box, you should consider using the Channel Fix feature by setting your TV to channel 3 or 4 (see page 20).



## TV, VCR, and Cable Box

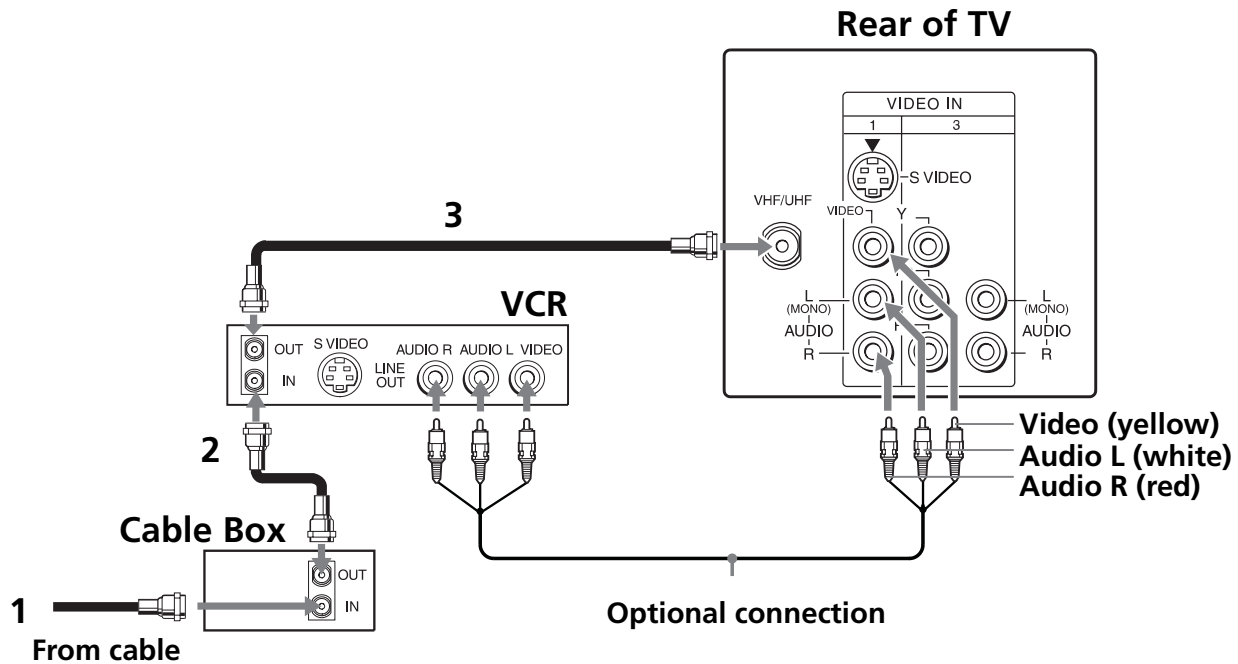

- 1** Connect the coaxial cable from your cable service to the IN jack on your cable box.
- 2** Connect a coaxial cable (not supplied) from the OUT jack on your cable box to the IN jack on your VCR.
- 3** Connect a coaxial cable (not supplied) from the OUT jack on your VCR to the VHF/UHF jack on the TV.

If you will be controlling all channel selection through your cable box, you should consider using the Channel Fix feature by setting your TV to channel 3 or 4 (see page 20).

### Optional connection

If your VCR is equipped with video outputs, you can get better picture quality by connecting Audio/Video cables (not supplied) from AUDIO and VIDEO OUT on your VCR to AUDIO/VIDEO IN on your TV.

You can use the button to switch between the VHF/UHF and VIDEO inputs.

For better picture quality, use S VIDEO instead of the yellow Audio/ Video cable. S VIDEO does not provide sound; the audio cables must still be connected.

## TV and Satellite Receiver

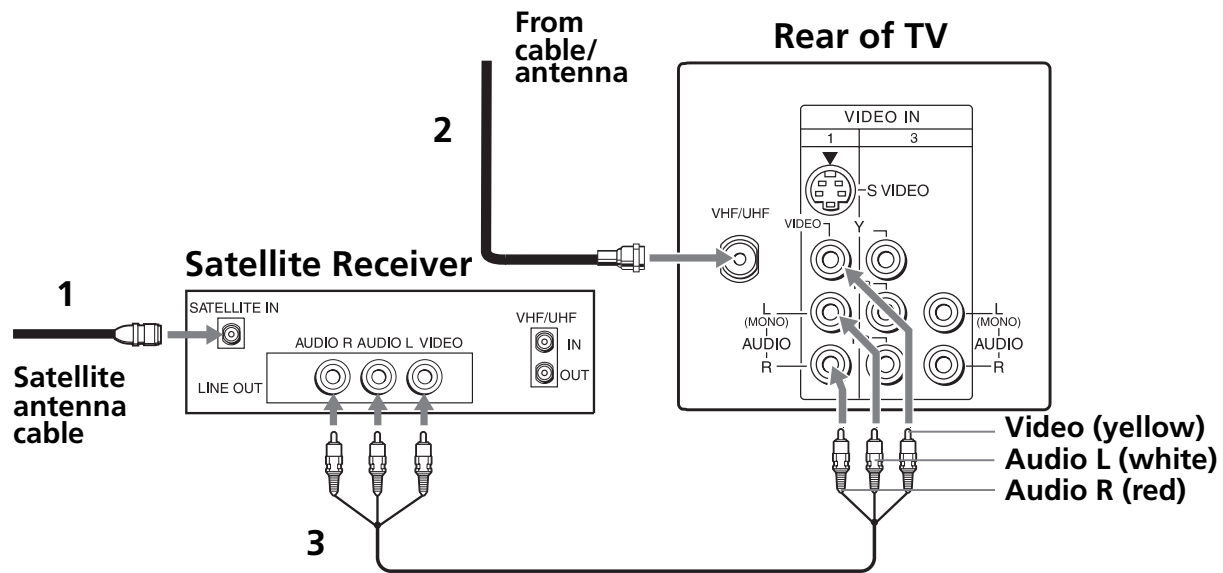

- 1** Connect the cable from your satellite antenna to SATELLITE IN on your satellite receiver.
- 2** Connect the coaxial cable from your cable service or antenna to the VHF/UHF jack on your TV.
- 3** Using Audio/Video cables (not supplied), connect AUDIO and VIDEO OUT on your satellite receiver to AUDIO and VIDEO IN on your TV.

 You can use the  button to switch between the VHF/UHF and VIDEO inputs.

 For better picture quality, use S VIDEO instead of the yellow Audio/ Video cable. S VIDEO does not provide sound; the audio cables must still be connected.

## TV, Satellite Receiver, and VCR

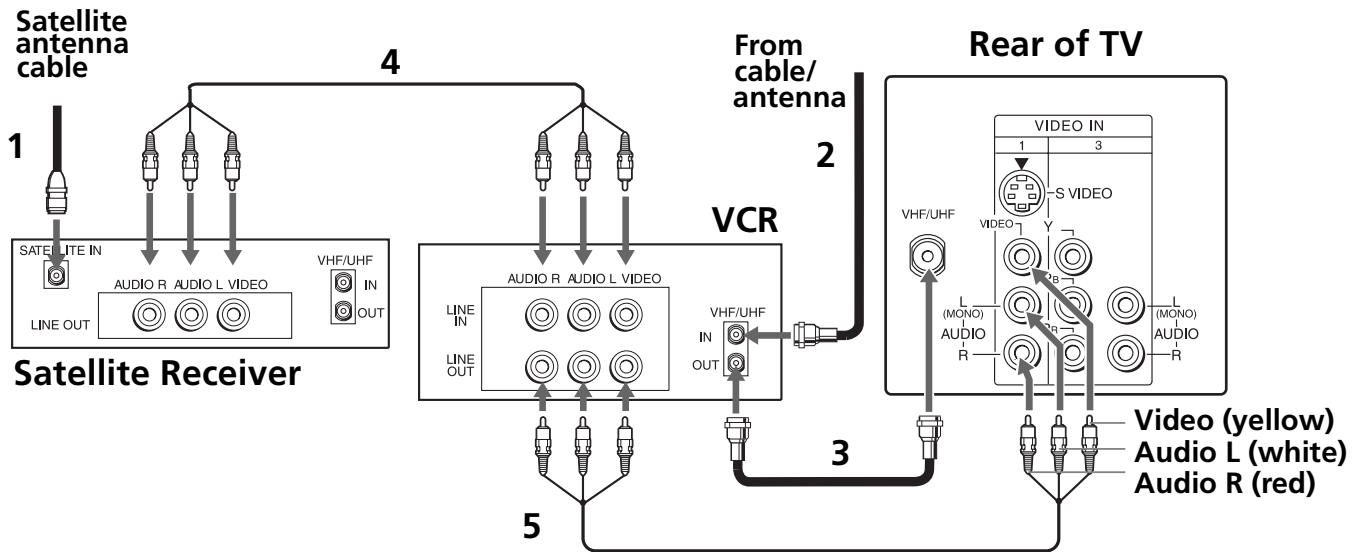

- 1** Connect the cable from your satellite antenna to SATELLITE IN on the satellite receiver.
- 2** Connect the coaxial cable from your cable service or antenna to the IN jack on your VCR.
- 3** Using a coaxial cable (not supplied), connect the OUT jack on your VCR to the VHF/UHF jack on your TV.
- 4** Using Audio/Video cables (not supplied), connect AUDIO and VIDEO OUT on your satellite receiver to AUDIO and VIDEO IN on your VCR.
- 5** Using Audio/Video cables (not supplied), connect AUDIO and VIDEO OUT on your VCR to AUDIO and VIDEO IN on your TV.

 To view from the satellite receiver or VCR, select the video input to which your satellite receiver or VCR is connected by pressing  $\text{TV/VIDEO}$  on the remote control.

## Connecting a DVD Player

Using Audio/Video cables (not supplied), connect AUDIO and VIDEO OUT on your DVD player to AUDIO and VIDEO IN on your TV.

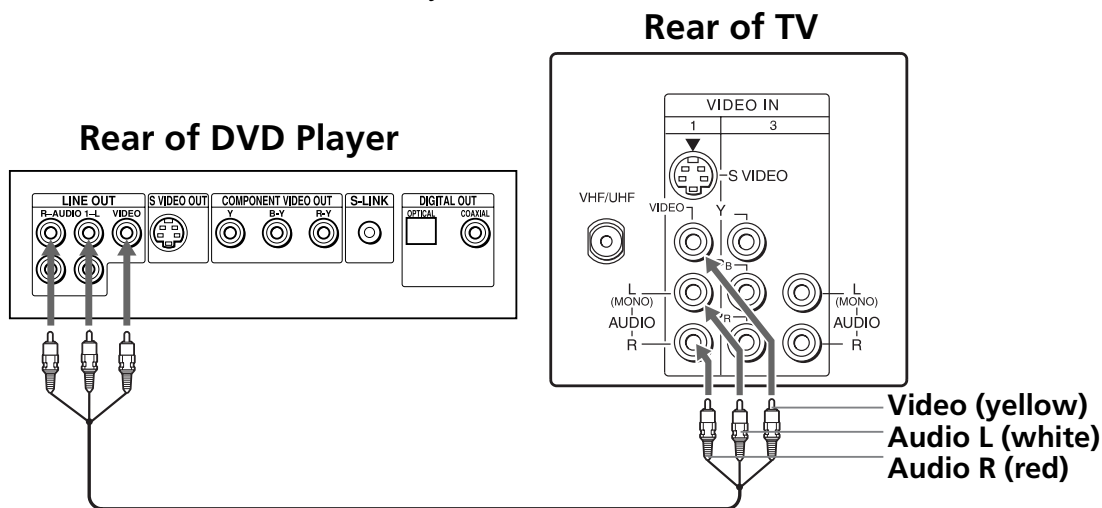

For better picture quality, use S VIDEO instead of the yellow Audio/ Video cable. S VIDEO does not provide sound; the audio cables must still be connected.

### Optional connection

If your DVD player is equipped with component video outputs (Y, P<sub>B</sub>, P<sub>R</sub>), you can optimize the picture quality by using component video cables.

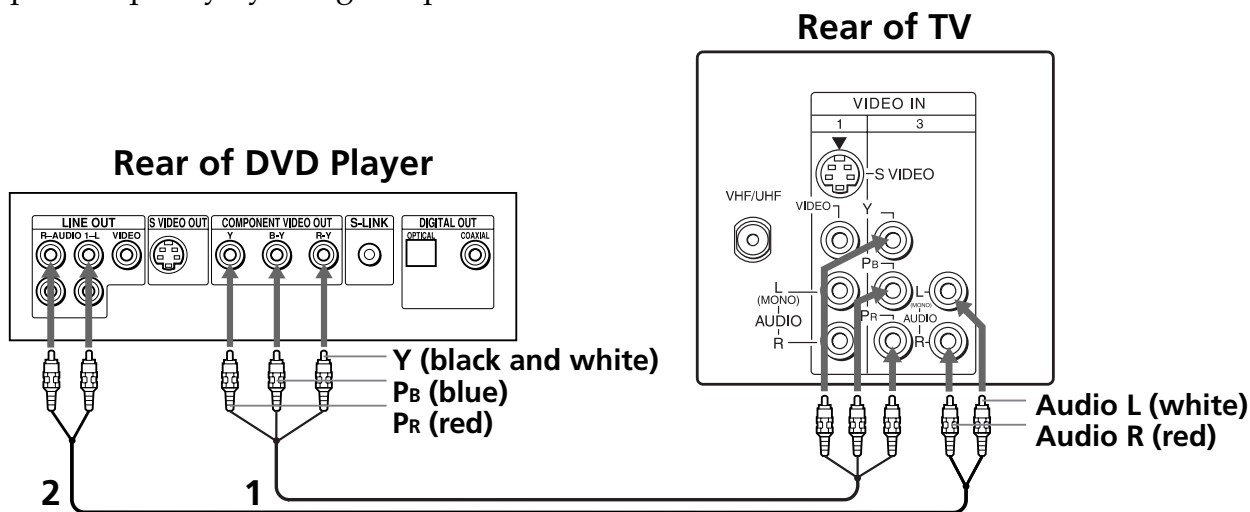

- 1** Using component video cables (not supplied), connect the Y, P<sub>B</sub>, P<sub>R</sub> OUT on your DVD player to Y, P<sub>B</sub>, P<sub>R</sub> IN on your TV.
- 2** Connect AUDIO OUT on your DVD player to AUDIO IN on your TV.

The Y, P<sub>B</sub>, P<sub>R</sub> outputs on your DVD player are sometimes labeled Y, C<sub>B</sub>, and C<sub>R</sub> or Y, B-Y, and R-Y. If so, connect the cables to like colors.

## Connecting a Camcorder

Using Audio/Video cables (not supplied), connect AUDIO and VIDEO OUT on your camcorder to AUDIO and VIDEO IN on your TV.

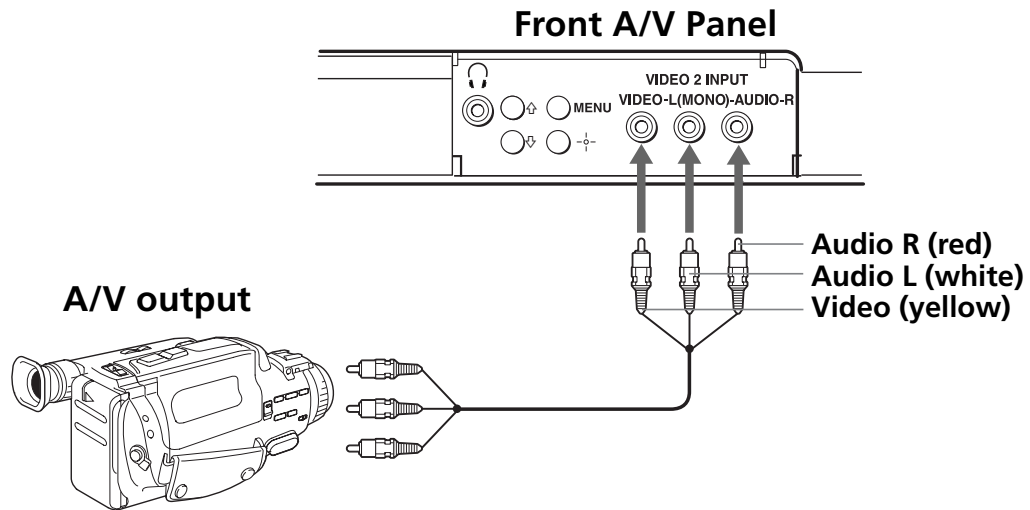

## Connecting Headphones

Connect the headphones to the  jack on the front of your TV. Headphone jack is STEREO.

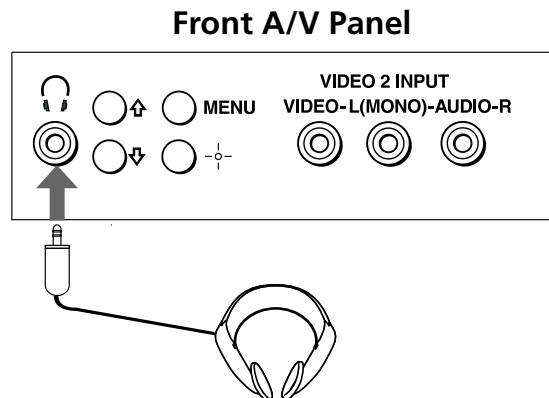

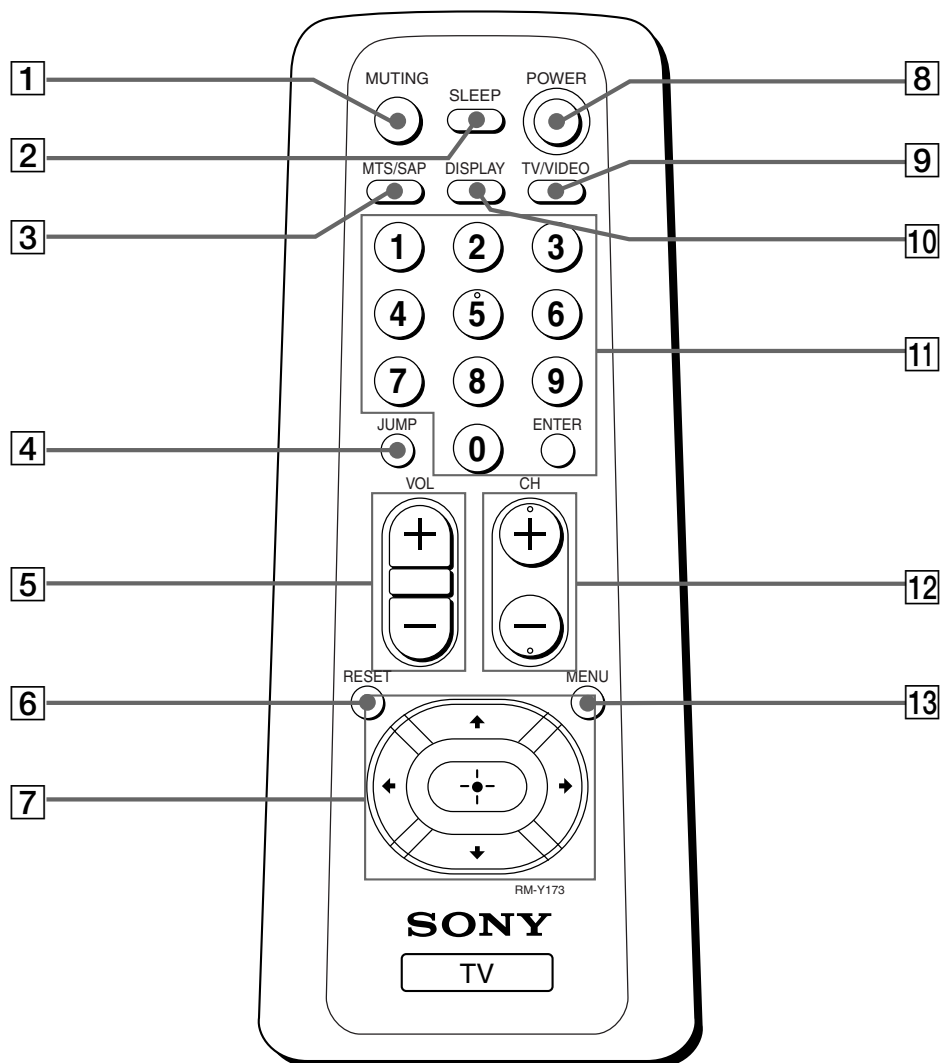

# Using the Remote Control and Basic Functions

This section shows you how to use the buttons on the remote control and how to navigate the on-screen menus.

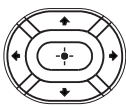

## Using the Remote Control

Button	Description
<b>1</b> <b>MUTING</b>	Instantly turns off the sound. Press again or press  to restore the sound.
<b>2</b> <b>SLEEP</b>	Turns the TV off automatically in approximately 15, 30, 45, 60, or 90 minutes. Cancel by pressing until SLEEP OFF appears.
<b>3</b> <b>MTS/SAP</b>	Cycles through the Multi-channel TV Sound (MTS) options: Stereo, Mono, and Auto SAP (Second Audio Program).
<b>4</b> <b>JUMP</b>	Press to jump back and forth between two channels. The TV alternates between current channel and the last channel that was selected.
<b>5</b> <b>VOL (volume)</b>	Press when you want to adjust the volume.
<b>6</b> <b>RESET</b>	Press to return to factory settings while in an on-screen menu.
<b>7</b> 	Moves the cursor in the on-screen menus. Press the arrow buttons to move the cursor, then press the center button to select or access an option.
<b>8</b> <b>POWER</b>	Press when you want to turn the TV on or off.
<b>9</b> <b>TV/VIDEO</b>	Cycles through available video inputs.
<b>10</b> <b>DISPLAY</b>	Press to display the current time (if set) and channel number. Press again to turn DISPLAY off.
<b>11</b> <b>0-9 and ENTER</b>	Change the channels directly. Press <b>0-9</b> buttons to select a channel, then press ENTER.
<b>12</b> <b>CH (channel)</b>	Press when you want to change channels.
<b>13</b> <b>MENU</b>	Displays the on-screen menu. Press again to exit the menu at any time.

 If you lose your remote control, see page 32.





# Setting Up the TV Automatically

After you have finished connecting your TV, you can perform Auto Program to set up your channels.











- 1 Press  to turn on the TV. The Initial Setup screen appears.



- 2 Press  on the remote control or on the TV front panel to perform Auto Program, or press  to exit.

 The Initial Setup screen appears each time you turn on the TV until you perform Auto Program.





## To perform Auto Program again

- 1 Press .
- 2 Press  to highlight Channel Setup (  ).
- 3 Press  to highlight Cable. Press  to select.
- 4 Press  or  to select On or Off according to how you connected your TV. Press .
- 5 Press  to highlight Auto Program. Press  to search for channels.

 After performing Auto Program, press  to exit.

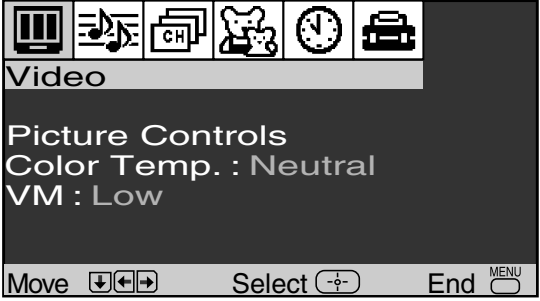
## Quick Start to the Menus

The following settings are available in your on-screen menus:

Menu	Allows you to
 <p>The screenshot shows the 'Video' menu with a header bar containing icons for Video, Music, Channel, Parental Control, Clock, and Print. Below the header, the text reads 'Picture Controls', 'Color Temp. : Neutral', and 'VM : Low'. At the bottom, there are navigation controls: 'Move' with left and right arrows, 'Select' with a central arrow, and 'End' with a 'MENU' icon.</p>	<p>Make adjustments to your picture settings.</p>
 <p>The screenshot shows the 'Audio' menu with the same header bar as the Video menu. The text below the header reads 'MTS : Stereo'. The navigation controls at the bottom are identical to the Video menu.</p>	<p>Change your audio settings.</p>
 <p>The screenshot shows the 'Channel Setup' menu with the same header bar. The text below the header lists several options: 'Favorite Channels', 'Cable : On', 'Channel Fix : Off', 'Auto Program', 'Channel Skip/Add', and 'Channel Label'. The navigation controls at the bottom are identical to the previous menus.</p>	<p>Customize your channel settings.</p>
 <p>The screenshot shows the 'Parental Control' menu with the same header bar. The text below the header reads 'Password : _ _ _ _'. The navigation controls at the bottom are identical to the previous menus.</p>	<p>Set rating limits on your TV based on a program's rating or content.</p>

 The menus shown in this manual are for KV-24FS100. Your menus may not look like those illustrated.

## Menu



## Allows you to

Set the clock on your TV and program scheduled viewing using Timer 1 and Timer 2.













Select closed captioning options, label video inputs, adjust tilt correction, select menu languages, or run a demo of the menus.

# Using the Menu

This section shows the options available for setting up and adjusting your TV.

## To Access a Menu

- 1** Press  to display the on-screen menu.
- 2** Use the  or  buttons to highlight the desired menu, then press .
- 3** Use the  or  buttons to highlight the desired option, then press .
- 4** Press  to complete the adjustment or follow the instructions that will appear on your screen to activate the desired option.
- 5** Press  to exit the menu.

 Press  once to display the on-screen menu, and press again to return to normal viewing. If no buttons are pressed, the menu closes automatically after about 90 seconds.

## Using the Video Menu

To access the Video menu, refer to the following steps:

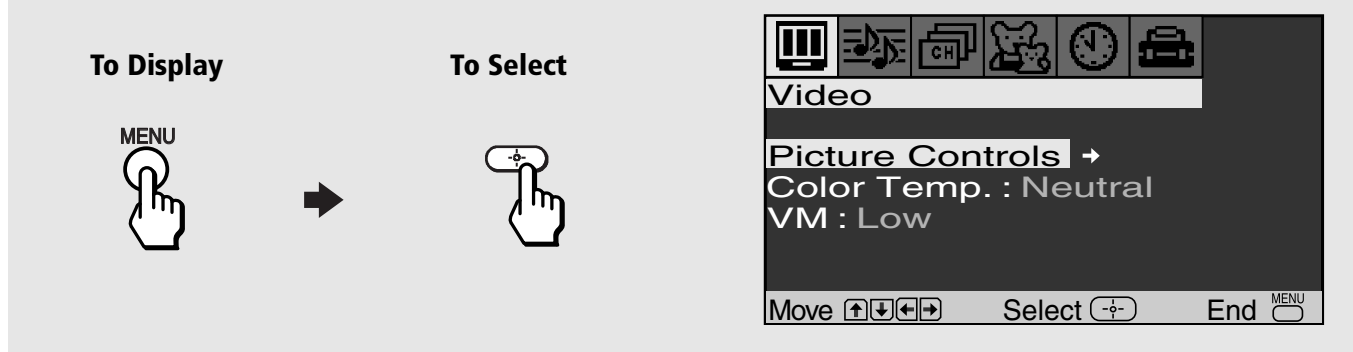

### Picture Controls

Press ⇨ to open Picture Controls menu:

#### Picture:

Press ⇐ to decrease the contrast. Press ⇨ to increase contrast.

#### Brightness:

Press ⇐ to darken the picture. Press ⇨ to brighten the picture.

#### Color:

Press ⇐ to decrease color saturation. Press ⇨ to increase color saturation.

#### Hue:

Press ⇐ to increase the red tones. Press ⇨ to increase the green tones.

#### Sharpness:

Press ⇐ to soften the picture. Press ⇨ to sharpen the picture.

### Color Temp. *White color tint adjustment*

Use the ⇧ or ⇩ buttons to select from one of the following options:

**Cool:** Gives the white colors a blue tint.

**Neutral:** Gives the white colors a neutral tint.

**Warm:** Gives the white colors a red tint.

### VM *Velocity Modulation*

#### **KV-20FS100 and KV-24FS100 only**

Sharpens picture definition to give objects a sharp, clean edge. Use the

⇧ or ⇩ buttons to select from one of the following options: **Off, High, Low.**

## Using the Audio Menu

To access the Audio menu, refer to the following steps:

To Display



To Highlight 



To Select



### MTS



*Multi-Channel  
TV Sound*

Press  or  to select one of the following options:

**Stereo:** Select when viewing a broadcast in stereo.

**Mono:** Select to reduce noise in areas of poor reception.





**Auto SAP:** Select to have the TV automatically switch to a Second Audio Program (SAP) when a signal is received.

 Press  to access MTS settings (Stereo, Mono, Auto SAP) directly.



 If your TV is set to Auto SAP, some programs may be muted or distorted. If your TV does not output sound, change your Audio setting to Stereo or Mono.

## Using the Channel Setup Menu

To access the Channel Setup menu, refer to the following steps:

<p><b>To Display</b></p> 	<p>→</p>	<p><b>To Highlight</b> </p> 	<p>→</p>	<p><b>To Select</b></p> 
--	----------	--	----------	---









Channel Setup  
 Favorite Channels →  
 Cable : On  
 Channel Fix : Off  
 Auto Program  
 Channel Skip/Add  
 Channel Label  
 Move  Select  End 

### **Favorite Channels**

*Quick access to favorite channels*

Press ⇨ to open the Favorite Channels menu:

- 1 Use the ↑ or ↓ buttons to select the position (1-5) where you want to set a favorite channel, then press .
- 2 Using the ↑ or ↓ button, select the desired channel.
- 3 Press  to change to the channel selected.
- 4 Press ⇨ to return to the Channel Setup menu or press  to exit.

 To use Favorite Channels: Exit all menus and press . Press ↑ or ↓ to move the cursor to the desired channel number and press .

### **Cable**

- On:** Select if you are receiving cable channels with a CATV cable.  
**Off:** Select if you are using a TV antenna.

 After changing your cable settings, you will need to perform Auto Program. When Channel Fix is set, you will not be able to use your Cable settings.

### **Channel Fix**

- 2-6:** Select when you want to control all channel selection through a cable box or VCR. Select the appropriate channel (usually 3 or 4) and use the cable box's or VCR's remote control for channel selection.  
**Video 1:** Select from available video inputs when you have connected video equipment (e.g. satellite receiver) and you want your TV fixed to it.  
**Off:** Channel Fix is not set.

### **Auto Program**

Press ⇨ to perform Auto Program.  
 The TV will scan through all available channels and program receivable channels.



**Channel Skip/Add**

Use this feature after you run Auto Program to skip unwanted channels or add new ones. Press  $\Rightarrow$  to open the Channel Skip/Add menu:

- 1 Use the  $\uparrow$  or  $\downarrow$  buttons to select the position of the desired channel, then press  $\oplus$ .
- 2 Use the  $\uparrow$  or  $\downarrow$  buttons to select Skip or Add, then press  $\oplus$ .
- 3 Press  $\Leftarrow$  to return to the Channel Setup menu or press  $\text{MENU}$  to exit.

 Pressing CH+ or CH- will skip over channels that have been skipped. You can still use the  $\text{0-9}$  buttons to directly tune to skipped channels.

**Channel Label**

*Label up to 40 channels with their call letters*

Press  $\Rightarrow$  to open the Channel Label menu:

- 1 Press  $\oplus$ , then press  $\uparrow$  or  $\downarrow$  until you reach the desired channel number. Press  $\oplus$  to activate the channel.
- 2 Press  $\oplus$ , then use the  $\uparrow$  or  $\downarrow$  button to display the first call letter or number of the caption, then press  $\oplus$  to select it. When finished, press  $\oplus$  to activate.

 Favorite Channels, Cable, Channel Skip/Add, and Channel Label cannot be used when Channel Fix is set.

## Parental Control

The Parental Control feature is designed to help parents monitor what their children watch on television. This section shows you the different rating systems available and how to set your TV's rating limit.

### Overview of the Ratings

Once you have become familiar with these rating systems, you should be ready to set your TV's rating limit.

### Movie Rating

#### (U.S. models only)

This system defines the rating levels of movies shown in theaters and on prime cable channels.

Rating	Defined as
<b>G</b>	General audience
<b>PG</b>	Parental Guidance suggested
<b>PG-13</b>	Parents strongly cautioned
<b>R</b>	Restricted
<b>NC-17</b>	No one 17 and under admitted
<b>X</b>	Adult audience only

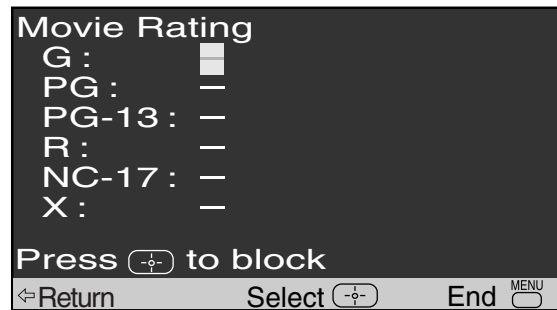

## TV Rating

### (U.S. models only)

The TV rating is divided into two groups: age-based and content-based.

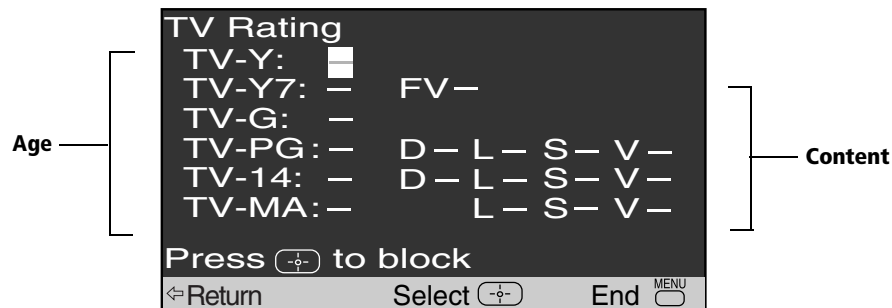

Age	Defined as	Content	Defined as
<b>TV-Y</b>	All children	<b>FV</b>	Fantasy Violence
<b>TV-Y7</b>	Directed to older children	<b>D</b>	Suggestive dialogue
<b>TV-G</b>	General audience	<b>L</b>	Strong language
<b>TV-PG</b>	Parental Guidance suggested	<b>S</b>	Sexual situations
<b>TV-14</b>	Parents strongly cautioned	<b>V</b>	Violence
<b>TV-MA</b>	Mature Audience only		

The content ratings will increase depending on the level of the age-based rating. For example, a program with a TV-PG V (Violence) rating may contain moderate violence, while a TV-14 V (Violence) rating may contain intense violence.

## Unrated

### (U.S. models only)

You have the option of blocking TV programs or movies that are not rated.

<b>Allow</b>	Allows all unrated programs
<b>Block</b>	Blocks all unrated programs

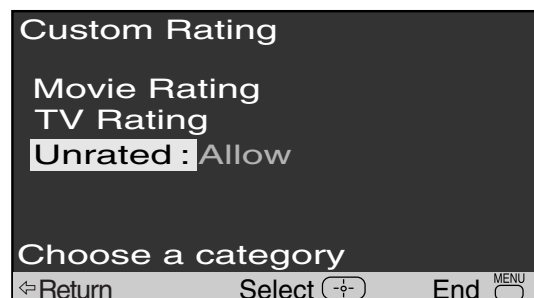

If you choose to block unrated TV programs, please be aware that the following programs may be blocked: emergency broadcasts, political programs, sports, news, public service announcements, religious programs, and weather.

## English Rating

### (Canadian models only)

These ratings are for Canadian programs that are broadcast in English.

Rating	Defined as
<b>C</b>	Children
<b>C8+</b>	Children 8 years and older
<b>G</b>	General programming
<b>PG</b>	Parental Guidance
<b>14+</b>	Viewers 14 and older
<b>18+</b>	Adult programming

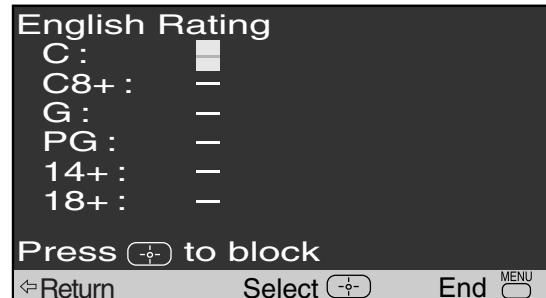

## French Rating

### (Canadian models only)

These ratings are for Canadian programs that are broadcast in French.

Rating	Defined as
<b>G</b>	General
<b>8 ans+ :</b>	Not recommended for younger children
<b>13 ans+ :</b>	Not recommended for children under age 13
<b>16 ans+ :</b>	Not recommended for ages under 16
<b>18 ans+ :</b>	This program is restricted to adults

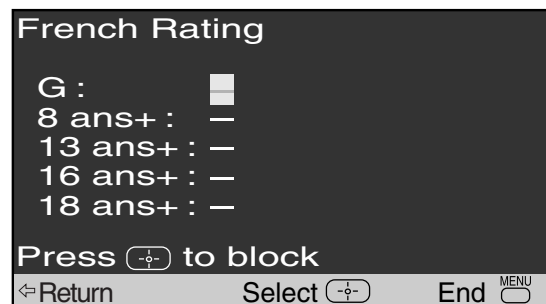





## U.S.A. Rating

### (Canadian models only)

For programs from the United States, please see "TV Rating" on page 23.

## Using the Parental Control Menu

To access the Parental Control menu, refer to the following steps:

<p><b>To Display</b></p> 	➔	<p><b>To Highlight</b> </p> 	➔	<p><b>To Select</b></p> 	
--	---	--	---	---	--

In the Parental Control  menu, you will be asked to set a 4-digit password for any further access into Parental Control.

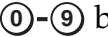
- 1** Press , then use the  buttons to enter a 4-digit password.

 Keep this manual in a safe place. If you forget your password, see page 32.

- 2** Confirm your password by entering it again.

Once your password is set correctly, the next Parental Control menu appears. For future access to this menu, use your password. A password is needed every time you want to access Parental Control menu.

## Setting the Rating

You can change the Rating by selecting one of the Lock options.



**1** With Lock highlighted, press .

If you are not familiar with the Parental Guidelines rating system, use one of the following preselected categories to simplify the rating selections: Child, Youth, Young Adult.

**2** Use the  or  buttons to select the desired rating, then press .

Rating	TV will allow a maximum rating of
Child	TV-Y, TV-G, G (U.S. models only), G (Canadian models only)
Youth	TV-PG, PG (U.S. models only), PG (Canadian models only)
Young Adult	TV-14, PG-13 (U.S. models only), 14+ (Canadian models only)
Custom	Select to set more restrictive ratings (see next section)
Off	No rating limit

## Changing your Password

**1** Use the  or  button to move the cursor to Change Password and press .

**2** Follow steps 1 and 2 for “Using the Parental Control Menu” on page 25.

## Information for Parents

### To view a program that exceeds the TV rating

Press , then use the - buttons to enter your password.

 Entering your password to view a blocked program will temporarily turn Lock to Off. To reactivate your Lock settings, turn the TV off. When you turn the TV on, your Lock settings are restored.

### Using the Custom Menu

Before setting Custom ratings, see pages 22-24, "Overview of the Ratings," for a description of the available rating systems.

Follow the instructions on the screen to make your custom settings. Select the country desired for your TV's rating limit. See page 23 for U.S. models and page 24 for Canadian models for more information.

 Once you have blocked a rating or content, all higher ratings or content will be automatically blocked.



## Using the Timer 🕒 Menu

To access the Timer menu, refer to the following steps:

**To Display**





**To Highlight** 🕒





**To Select**







- Current Time** Set your TV to the current day and time.  
 Press ⇨ to open Current Time menu:
- 1 Use the ⬆ or ⬇ button to enter the day and time, then press ⊕.
  - 2 Press  to exit the menu.

 You must set the Current Time before you can use Timer 1 and Timer 2.

- Timer 1 and Timer 2**  
*Scheduled viewing*
- Use your timers settings to program your TV by day, time, duration and channel. The timer's duration is maximum of 6 hours. When the channel is fixed, it is not necessary to set the channel.  
 With the menu open, set cursor on Timer 1 or Timer 2:
- 1 Press ⬆ or ⬇ to select Timer 1 or Timer 2, then press ⊕.
  - 2 Press ⬆ or ⬇ to enter the desired day, time, duration and channel, then press ⊕. The Timer status should be On when the Timer has been set.
  - 3 Press  to exit the menu.

 You can set the Timer to On, Off, or Set. Once the timer is set, you can turn it On or Off without having to go through the settings. When you set Timer 1 or Timer 2, a red light on the front panel of your TV will turn on.

 When you perform Auto Program, Timer 1 and Timer 2 settings will be cleared. Also, in the event of any loss of power, Current Time and Timer 1 and Timer 2 settings will be cleared.

## Using the Setup Menu

To access the Setup menu, refer to the following steps:

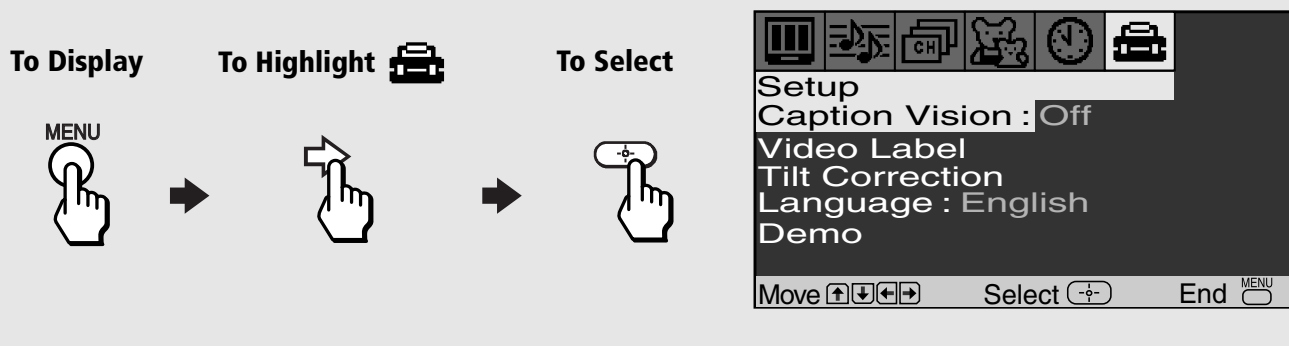

<b>Caption Vision</b> <i>Closed-Captioning</i>	Allows you to select from three closed caption modes (for programs that are broadcast with closed caption). Press $\uparrow$ or $\downarrow$ to select one of the following options: <b>CC1, 2, 3, 4:</b> Displays printed dialogue and sound effects of a program. <b>Text1, 2, 3, 4:</b> Displays network/station information. <b>XDS (Extended Data Services):</b> Displays the name of the current program and its remaining time, if available. <b>Off:</b> Caption Vision is not activated.
<b>Video Label</b> <i>Label connected equipment</i>	Allows you to label the audio/video components you connected to the TV: VCR, DVD, etc. When you press TV/VIDEO to switch inputs, the Video Label will display on-screen. Press $\Rightarrow$ to open the Video Label menu: <b>1</b> Press $\uparrow$ or $\downarrow$ to access the input you want to label and press $\odot$ . <b>2</b> Press $\uparrow$ or $\downarrow$ to choose a label and press $\odot$ .
<b>Tilt Correction</b>	Press $\Rightarrow$ to open Tilt Correction: Press $\uparrow$ or $\downarrow$ to correct any tilt of the picture from -5 to +5, then press $\odot$ to activate and return to the Setup menu.
<b>Language</b>	Display all menus in the language of your choice. Use the $\uparrow$ or $\downarrow$ buttons to select desired language and press $\odot$ .
<b>Demo</b>	Press $\odot$ to run a demonstration of the on-screen menus.

 You can press any key to exit the Demo mode.



# Other Information

## Troubleshooting

If you are having a problem with your TV, try the suggestions below. If the problem persists, contact your nearest Sony Dealer.

---

<b>No picture, no sound</b>	<ul style="list-style-type: none"><li><input type="checkbox"/> Make sure the power cord is plugged in.</li><li><input type="checkbox"/> If a red light is flashing on the front of your TV for more than a few minutes, disconnect and reconnect the power cord to restore the TV. If the problem continues, call your local service center.</li><li><input type="checkbox"/> Check the TV/VIDEO settings: when watching TV, set to TV; when watching video equipment, set to VIDEO (page 13).</li><li><input type="checkbox"/> Make sure the batteries have been inserted correctly into the remote control (page 2).</li><li><input type="checkbox"/> Try another channel; it could be station trouble.</li></ul>
<b>Poor or no picture, good sound</b>	<ul style="list-style-type: none"><li><input type="checkbox"/> Adjust Picture in the Picture Controls menu under Video (page 18).</li><li><input type="checkbox"/> Adjust Brightness in the Picture Controls menu under Video (page 18).</li><li><input type="checkbox"/> Check the antenna and/or cable connections (page 4).</li></ul>
<b>Good picture, no sound</b>	<ul style="list-style-type: none"><li><input type="checkbox"/> Press  so that MUTING disappears from the screen (page 13).</li><li><input type="checkbox"/> Check your Audio settings. Your TV may be set to Auto SAP (page 19).</li></ul>
<b>No color</b>	<ul style="list-style-type: none"><li><input type="checkbox"/> Adjust Color in the Picture Controls menu under Video (page 18).</li></ul>
<b>Only snow appears on the screen</b>	<ul style="list-style-type: none"><li><input type="checkbox"/> Check the Cable setting in the Channel Setup menu (page 20).</li><li><input type="checkbox"/> Check the antenna and/or cable connections (page 4).</li><li><input type="checkbox"/> Make sure the channel selected is currently broadcasting.</li></ul>
<b>Dotted lines or stripes</b>	<ul style="list-style-type: none"><li><input type="checkbox"/> Adjust the antenna.</li><li><input type="checkbox"/> Move the TV away from other electronic equipment. Some electronic equipment can create electrical noise, which can interfere with TV reception.</li></ul>
<b>Double images or ghosts</b>	<ul style="list-style-type: none"><li><input type="checkbox"/> Check your outdoor antenna or call your cable service.</li></ul>

---

<b>Cannot receive higher number channels (UHF) when using an antenna</b>	<ul style="list-style-type: none"><li><input type="checkbox"/> Make sure Cable is set to Off in the Channel Setup menu (page 20).</li><li><input type="checkbox"/> Perform Auto Program to add channels that are not presently in the memory (page 14).</li></ul>
<b>Cable stations don't seem to work</b>	<ul style="list-style-type: none"><li><input type="checkbox"/> Make sure Cable is set to On in the Channel Setup menu (page 20).</li><li><input type="checkbox"/> Perform Auto Program to add channels that are not presently in the memory (page 14).</li></ul>
<b>Remote control does not operate</b>	<ul style="list-style-type: none"><li><input type="checkbox"/> Batteries could be weak. Replace them (page 2).</li><li><input type="checkbox"/> Move the TV 3-4 or more feet away from fluorescent lights.</li></ul>
<b>The TV needs to be cleaned</b>	<ul style="list-style-type: none"><li><input type="checkbox"/> Clean the TV with a soft dry cloth. Never use strong solvents such as thinner or benzine, which might damage the finish of the cabinet.</li></ul>
<b>Lost password for Parental Control</b>	<ul style="list-style-type: none"><li><input type="checkbox"/> In the password screen, enter the following master password: 4357. After using the master password, you must create a new password, it cannot be used to unlock currently blocked channels.</li></ul>
<b>You lost your remote control</b>	<ul style="list-style-type: none"><li><input type="checkbox"/> You can use the front Audio/Video panel controls to access the menu (page 2). Contact your nearest Sony Dealer to order a replacement.</li></ul>

*If, after reading these Operating Instructions, you have additional questions related to the use of your Sony television, please call our Direct Response Center at 1-800-222-SONY (7669) (U.S. residents only) or (416) 499-SONY (7669) (Canadian residents only).*

## Specifications

### For all models (except as noted)

Television system	American TV standard/NTSC
Channel coverage	VHF: 2-13/UHF: 14-69/CATV: 1-125
Antenna	75-ohm external antenna terminal for VHF/UHF
Picture tube	FD Trinitron® tube
Power requirements	120V, 60 Hz
Supplied Accessories	Size AA (R6) batteries (2) Remote Control RM-Y173 (1)
Optional Accessories	Connecting cables VMC-810S/820S, VMC-720M, YC-YC-15V/30V, RK74A EAC-66 U/V mixer

### **KV-13FS100, KV-13FS110**

Screen size	Visible screen size: 13 inches (330 mm) measured diagonally Actual screen size: 14 inches (355.6 mm) measured diagonally
Inputs/outputs	2 video, 2 audio 1 Y, P <sub>B</sub> , P <sub>R</sub> , 1 audio 1 headphone jack
Speaker output	3 W x 2
Power Consumption	100 W in use 1 W in standby
Dimensions (W/H/D)	407 x 340 x 411 mm (16x 13 <sup>3</sup> / <sub>8</sub> x 16 <sup>1</sup> / <sub>8</sub> in.)
Mass	12 kg (26 lbs. 7 oz.)

### **KV-20FS100**

Screen size	Visible screen size: 20 inches (508 mm) measured diagonally Actual screen size: 21 inches (533.4 mm) measured diagonally
Inputs/outputs	2 video, 2 audio 1 Y, P <sub>B</sub> , P <sub>R</sub> , 1 audio 1 headphone jack
Speaker output	5 W x 2
Power Consumption	120 W in use 1 W in standby
Dimensions (W/H/D)	592 x 466 x 494 mm (23 <sup>1</sup> / <sub>4</sub> x 18 <sup>3</sup> / <sub>8</sub> x 19 <sup>1</sup> / <sub>2</sub> in.)
Mass	24.8 kg (54 lbs. 10 oz.)

---

**KV-24FS100**

---

Screen size	Visible screen size: 24 inches (610 mm) measured diagonally Actual screen size: 25 inches (635 mm) measured diagonally
Inputs/outputs	2 video, 2 audio 1 S VIDEO 1 Y, PB, PR, 1 audio 1 headphone jack
Speaker output	7.5 W x 2
Power Consumption	145 W in use 1 W in standby
Dimensions (W/H/D)	704 x 524 x 472 mm (27 <sup>3</sup> / <sub>4</sub> x 20 <sup>5</sup> / <sub>8</sub> x 18 <sup>1</sup> / <sub>2</sub> in.)
Mass	35 kg (77 lbs. 1oz.)

---

Design and specifications are subject to change without notice.

# Index

## A

Audio  Menu 19  
Auto Program 14, 20  
Auto SAP 19

## B

Battery Installation 2  
Brightness 18

## C

Cable 20  
Caption Vision 29  
Channel Fix 20  
Channel Label 21  
Channel Setup  Menu 20  
Channel Skip/Add 21  
Color 18  
Connections  
    Cable and Antenna 4  
    Connecting a Camcorder 11  
    Connecting a DVD Player 10  
    Connecting Headphones 11  
    TV and Cable Box 6  
    TV and VCR 5  
    TV and Satellite Receiver 8  
    TV, Satellite Receiver, and VCR 9  
    TV, VCR, and Cable Box 7  
Current Time 28

## D

Demo 29  
DISPLAY 13

## F

Favorite Channels 20  
Front A/V Panel (*see TV Front Panel*) 2





## H

Hue 18

## L

Language 29

## M

Menus  
    Audio  19  
    Channel Setup  20  
    Parental Control  25  
    Setup  29  
    Timer  28

Video  18  
Mono 19  
MTS  
    Auto SAP 19  
    Mono 19  
    Stereo 19

## P

Parental Control 22  
Parental Control  menu 25  
Picture 18  
Picture Controls 18  
    Brightness 18  
    Color 18  
    Hue 18  
    Picture 18  
    Sharpness 18

## R

Ratings  
    English Rating 24  
    French Rating 24  
    Movie Rating 22  
    TV Rating 23  
    Unrated 23  
    U.S.A. Rating 24  
Remote Control 12

## S

Setup  menu 29  
Sharpness 18  
SLEEP 13  
Specifications 33  
Stereo 19

## T

Tilt Correction 29  
Timer  Menu 28  
Timer 1 and Timer 2 28  
Troubleshooting 31  
TV Features 1  
TV Front Panel 2  
TV Rear Panel 3

## V

Video  Menu 18  
Video Label 29  
VM 18



Sony Corporation Printed in U.S.A.



**FD Trinitron**  
**WEGA**<sup>®</sup>

---

Mode d'emploi

**KV-13FS100**  
**KV-13FS110**  
**KV-20FS100**  
**KV-24FS100**



# AVERTISSEMENT

Afin d'éviter tout risque d'incendie ou d'électrocution, ne pas exposer cet appareil à la pluie ou à l'humidité.



Ce sigle vise à signaler à l'utilisateur la présence d'une "tension dangereuse" non isolée au sein de l'appareil, dont la puissance peut être suffisante pour provoquer un risque d'électrocution.



Ce sigle vise à signaler à l'utilisateur la présence d'une documentation importante concernant les instructions de fonctionnement et d'entretien de cet appareil.

## Remarque aux installateurs du système de télévision par câble

L'attention des installateurs du système de télévision par câble est attirée sur l'article 820-40 du NEC (National Electrical Code - Etats Unis) qui énonce les directives concernant le raccordement à la masse, stipulant en particulier qu'il doit être branché à celui de l'immeuble (ou maison), et aussi proche que possible du point d'entrée du câble.

## PRECAUTIONS DE SECURITE

- ❑ N'utiliser l'appareil que sur du courant alternatif 120 V.
- ❑ L'une des lames de la fiche est plus large que l'autre pour des raisons de sécurité et ne s'adapte dans la prise que dans un seul sens. Consultez votre revendeur si vous ne parvenez pas à brancher la fiche totalement.
- ❑ Si un liquide ou un objet quelconque venait à s'introduire dans l'appareil, débranchez immédiatement le cordon d'alimentation et faites vérifier le téléviseur par un technicien qualifié avant de le remettre en service.

## ATTENTION

Lorsque vous utilisez des jeux, des ordinateurs et d'autres appareils similaires avec votre téléviseur, réglez la brillance et le contraste à des valeurs basses. Une image restant fixe sur l'écran pendant un temps prolongé peut s'y imprimer en permanence lorsque la brillance ou le contraste sont trop élevés. De même, la visualisation continue d'un même canal peut provoquer l'impression du logo du canal. Ces impressions ne sont pas couvertes par votre garantie car elles résultent d'une utilisation incorrecte du téléviseur.



**Pour éviter tout risque d'électrocution, n'utilisez pas cette fiche d'alimentation secteur polarisée avec une rallonge, une prise de courant ou avec une autre prise si les lames ne peuvent être introduites complètement afin d'éviter que des parties de lame nue restent exposées.**

 Vous êtes averti que tout changement ou modification non expressément approuvé dans le présent mode d'emploi peut invalider votre droit à utiliser cet appareil.

## AVIS

Cet appareil a été testé et approuvé en conformité avec les limites qui définissent un appareil numérique de classe B suivant la partie 15 des règlements du Centre de contrôle des fréquences (FCC). Ces limites sont conçues pour assurer une protection raisonnable pour une installation en résidence privée.

Cet appareil génère, utilise, et peut émettre, de l'énergie sur les fréquences radios, et, s'il n'est pas utilisé en suivant les instructions, peut causer des interférences nuisibles aux communications radio. Cependant, il n'y a pas de garantie qu'aucune interférence ne sera produite dans une installation particulière. Si cet appareil cause une interférence nuisible à la réception de la radio ou de la télévision, ce qu'on peut déterminer en éteignant et en rallumant l'appareil, l'utilisateur est encouragé à réduire l'interférence par les mesures suivantes :

- Ré-orienter ou déplacer les antennes réceptrices.
- Augmenter la distance entre l'appareil et le récepteur.
- Brancher l'appareil sur une prise différente de celle où est branché le récepteur.
- Consulter et se faire aider par le revendeur ou un technicien radio/télévision expérimenté.

## Protection du téléviseur

- Pour éviter toute surchauffe interne, évitez de boucher les orifices de ventilation.
- N'installez pas l'appareil dans un endroit surchauffé, trop humide, poussiéreux, ou soumis à des vibrations mécaniques excessives.

## Remarque sur l'affichage des sous-titres d'image

Ce téléviseur permet d'afficher les sous-titres d'image en accordance avec § 15.119 des règlements du Centre de contrôle des fréquences (FCC).

L'utilisation de ce téléviseur à d'autres fins qu'une vue par des particuliers des émissions transmises par les canaux UHF ou VHF ou par des sociétés de câble pour le grand public peut nécessiter l'accord de ces sociétés ou du propriétaire de l'émission.

## Références utilisateur

Les numéros de modèle et de série sont situés sur la couverture avant du présent mode d'emploi et à l'arrière du téléviseur.

## Marques commerciales et droits d'auteur

ENERGY STAR<sup>®</sup> est une marque déposée aux États-Unis.



Comme associé au programme ENERGY STAR<sup>®</sup>, Sony a déterminé que ce produit ou ces modèles de produit satisfaisaient aux critères d'efficacité et de conservation de l'énergie posés par les directives ENERGY STAR<sup>®</sup>.

# Consignes de sécurité importantes

Pour votre protection, veuillez lire entièrement ces instructions et les conserver à toutes fins utiles. Observez et respectez scrupuleusement tous les avertissements, précautions et instructions spécifiés sur l'appareil, ou décrits dans le mode d'emploi ou le manuel d'entretien.

## AVERTISSEMENT

Pour éviter tout risque de blessure, veuillez respecter les précautions de sécurité élémentaires suivantes lors de l'installation, l'utilisation et la réparation de l'appareil.

## Utilisation

### Sources d'alimentation

Cet appareil ne doit être alimenté que sur le type de source d'alimentation indiqué sur la plaque du numéro de série/modèle. Si vous n'êtes pas sûr du type d'alimentation électrique de votre domicile, consultez votre revendeur ou la société locale de distribution électrique. En ce qui concerne les appareils conçus pour fonctionner sur une alimentation par batterie, reportez-vous au mode d'emploi.

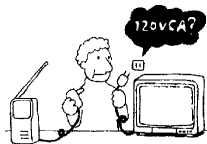

### Mise à la terre ou polarisation

Cet appareil est équipé d'une fiche d'alimentation secteur polarisée (une lame de la fiche est plus large que l'autre) ou d'une fiche à trois broches avec fil de terre (la troisième broche sert pour la mise à la terre). Suivez les instructions ci-dessous:

### Pour un appareil équipé d'une fiche d'alimentation secteur polarisée

Cette fiche ne se branche sur la prise secteur que d'une seule manière. C'est un dispositif de sécurité. Si vous ne parvenez pas à enfoncer la fiche à fond dans la prise, essayez de la retourner. Si la fiche ne correspond toujours pas, contactez votre électricien pour faire poser une prise adéquate. N'annulez pas le dispositif de sécurité de la prise polarisée en forçant dessus.



### Avertissement alternatif

### Pour un appareil équipé d'une fiche secteur à trois broches

Cette fiche ne peut être insérée que dans une prise secteur avec mise à la terre. C'est un dispositif de sécurité. Si vous ne parvenez pas à insérer la fiche dans la prise, contactez votre électricien pour faire poser une prise adéquate. N'annulez pas le dispositif de sécurité de la fiche de terre.

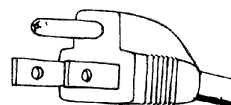

## Surcharge

Ne surchargez pas les prises murales, les rallonges ou autres prises de courant au-delà de leur capacité, car il y a risque d'incendie ou d'électrocution.

Mettez toujours l'appareil hors tension lorsqu'il n'est pas utilisé. Si vous n'avez pas l'intention de l'utiliser pendant longtemps, débranchez-le de la prise murale, par précaution, pour éviter la possibilité qu'une anomalie interne crée un début d'incendie.

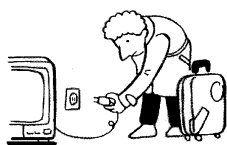
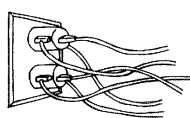

Ne débranchez pas le câble d'antenne ou le cordon d'alimentation pendant un violent orage. La foudre pourrait en effet vous frapper alors que vous tenez le câble ou le cordon et vous causer ainsi de graves blessures. Mettez le téléviseur hors tension et attendez que l'orage passe.

## Pénétration d'un corps solide ou liquide

N'enfoncez jamais un objet quel qu'il soit dans le téléviseur par les fentes d'aération car il pourrait toucher des points de haute tension ou court-circuiter des pièces, et provoquer ainsi un incendie ou une électrocution. Ne renversez jamais de liquide quel qu'il soit dans l'appareil.



## Raccordements

N'utilisez pas de cordons qui ne sont pas recommandés par le fabricant, car ils pourraient être dangereux.

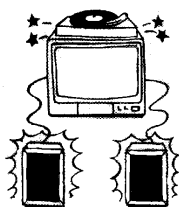

Ne posez pas d'objets, et tout spécialement des objets lourds sur le téléviseur. Ces objets pourraient tomber et vous blesser ou blesser une autre personne.

## Nettoyage

Débranchez la fiche de la prise murale avant de nettoyer ou de lustrer l'appareil.

N'utilisez pas de nettoyant liquide ou en vaporisateur. Nettoyez l'extérieur de l'appareil avec un chiffon légèrement humidifié à l'eau.



Si l'appareil produit continuellement ou fréquemment des bruits de claquement ou des bruits secs pendant son fonctionnement, débranchez-le et consultez votre revendeur ou un réparateur. Certains téléviseurs font entendre occasionnellement des bruits de claquement ou des bruits secs, en particulier au moment de la mise sous ou hors tension, mais c'est tout à fait normal



## Installation

Demandez toujours l'assistance d'une autre ou de plusieurs autres personnes pour soulever ou déplacer le téléviseur. Le téléviseur est lourd et offre peu de prise dans sa partie inférieure. Vous pourriez vous blesser gravement si vous essayez de déplacer le téléviseur seul ou si vous le manipulez de manière instable.

Installez le téléviseur sur une surface stable et de niveau.

## Attention à l'eau et à l'humidité

N'utilisez pas un appareil alimenté sur le secteur près de lieux où se trouve de l'eau, comme une baignoire, un lavabo, un évier ou un bac à laver, dans un sous-sol humide ou près d'une piscine, etc.

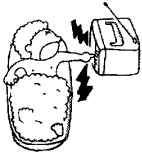

## Accessoires

Ne posez pas l'appareil sur un chariot, un support, une table ou une étagère instable. Il risque de tomber et de blesser gravement un enfant ou un adulte, et l'appareil risque d'être sérieusement endommagé. N'utilisez qu'un chariot ou un support recommandé par le fabricant pour ce modèle de téléviseur.

Pour déplacer un téléviseur placé sur un chariot, poussez-le avec précaution. L'ensemble chariot-téléviseur risque de se renverser en cas d'arrêt brusque, de poussée excessive ou de surface inégale.

Débranchez tous les câbles et tous les cordons avant d'essayer de déplacer le téléviseur.



Ne laissez pas des enfants ou des animaux domestiques monter sur le téléviseur ou le pousser. Le téléviseur pourrait en effet tomber, risquant ainsi de vous blesser sérieusement.

## Ventilation

Les fentes et les ouvertures aménagées sur le coffret et au dos ou au bas de l'appareil sont prévues pour la ventilation nécessaire. Pour assurer un fonctionnement fiable et pour protéger le téléviseur d'une surchauffe, ces fentes et ouvertures ne doivent jamais être bloquées ou recouvertes.

- Ne couvrez jamais les fentes et les ouvertures avec un chiffon ou autre morceau de tissu.

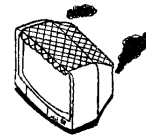

- Ne bloquez jamais les fentes et ouvertures en plaçant l'appareil sur un lit, un canapé, un tapis ou autre surface similaire.

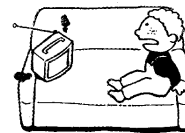

- N'encastrez jamais l'appareil dans un endroit fermé, comme une bibliothèque ou un meuble, sauf si une ventilation adéquate est assurée.

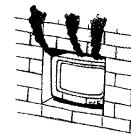

- Ne posez pas l'appareil sur ou près d'un radiateur ou d'un système de chauffage, ou dans un endroit exposé au soleil.



## Protection du cordon d'alimentation

Ne laissez jamais un objet rouler sur le cordon d'alimentation ou poser un objet lourd dessus. N'installez pas l'appareil dans un endroit où le cordon d'alimentation pourrait s'user prématurément ou être endommagé.





## Mise à la masse ou polarisation

Ce téléviseur peut être équipé d'une prise polarisée pour courant alternatif (une prise équipée de deux plots de largeur inégale). Cette prise ne peut être branchée sur le secteur que d'une seule façon. Il s'agit d'une fonction de sécurité. Si vous n'arrivez pas à brancher la prise complètement, retournez-la et essayez à nouveau. Si la prise ne peut toujours pas être branchée, contactez un électricien pour qu'il remplace la prise murale.

Ne désactivez pas la fonction de sécurité de la prise polarisée.

## Antennes

### Mise à la terre de l'antenne extérieure

Si vous installez une antenne extérieure, veuillez respecter les précautions ci-dessous. Une antenne extérieure ne doit pas être installée près de lignes électriques aériennes ou autres circuits d'alimentation ou d'éclairage électriques, ou dans un endroit où elle pourrait toucher de tels circuits ou lignes.

LORS DE L'INSTALLATION D'UNE ANTENNE EXTÉRIEURE, SOYEZ EXTRÊMEMENT PRUDENT POUR ÉVITER DE TOUCHER DE TELS CIRCUITS OU LIGNES ÉLECTRIQUES, CAR UN TEL CONTACT ENTRAÎNE PRATIQUEMENT TOUJOURS LA MORT.

L'antenne doit être reliée à la terre par mesure de sécurité contre les hausses brusques de tension et l'électricité statique accumulée. La section 810 du National Electrical Code (NEC) aux États-Unis et la section 54 du Code canadien de l'électricité fournissent des informations sur le raccordement à la terre correct du mât et de la structure porteuse, le raccordement de la descente d'antenne à une unité de déchargement d'antenne, la taille des conducteurs de mise à la terre, l'emplacement de l'unité de décharge d'antenne, la connexion aux électrodes de terre, et les spécifications des électrodes de terre.

### Mise à la terre de l'antenne selon le NEC

Reportez-vous à la section 54-300 du Code canadien de l'électricité en ce qui concerne la mise à la terre de l'antenne.

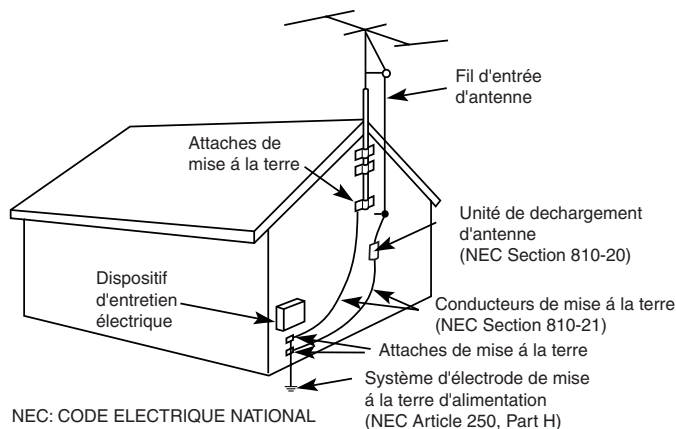

## Foudre

Pour une protection supplémentaire de cet appareil récepteur de télévision durant les orages accompagnés de foudre, ou lorsque l'appareil doit rester sans surveillance et sans usage pour des périodes prolongées, débranchez-le de sa prise murale et déconnectez l'antenne. Ceci évitera l'endommagement de l'appareil causé par la foudre et les surtensions.

## Dépannage

### Dommages nécessitant un dépannage

Débranchez l'appareil de la prise murale et faites-le réparer par un réparateur qualifié dans les cas suivants:

- **Le cordon ou la fiche d'alimentation est abîmé ou dénudé.**



- **Du liquide s'est renversé dans l'appareil ou des objets sont tombés dedans.**

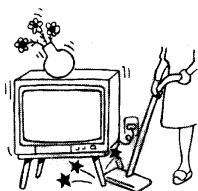

- **L'appareil a été mouillé ou exposé à la pluie.**



- **L'appareil est tombé et a été cogné violemment, ou bien le coffret est abîmé.**

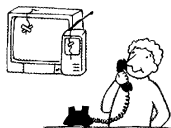

- **L'appareil ne fonctionne pas normalement alors que vous avez respecté toutes les instructions du mode d'emploi. N'agissez que sur les commandes spécifiées dans le mode d'emploi. Tout réglage incorrect d'une autre commande risque d'endommager l'appareil et de nécessiter un important travail par un technicien qualifié pour le réparer.**

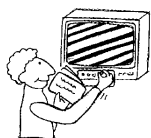

- **Une baisse sensible des performances indique que l'appareil a besoin d'être réparé.**

## Réparation

N'essayez pas de réparer l'appareil vous-même; vous risquez d'être exposé à des hautes tensions dangereuses ou autres risques en ouvrant le coffret. Pour toute réparation, adressez-vous à un réparateur qualifié.



## Remplacement des pièces

Si des pièces doivent être remplacées, n'oubliez pas de demander au réparateur d'attester par écrit qu'il a utilisé des pièces de rechange spécifiées par le fabricant, avec les mêmes caractéristiques que les pièces originales. Toute substitution non autorisée peut être la cause d'un incendie, d'une électrocution ou autre danger.



## Révision de sécurité

A l'occasion de tout dépannage ou réparation de l'appareil, demandez au réparateur d'effectuer une révision de sécurité de routine (comme spécifié par le fabricant) pour déterminer si l'appareil offre une bonne sécurité de fonctionnement, et faites-le certifier par écrit. Lorsque l'appareil atteint la fin de sa vie utile, ne le jetez pas n'importe comment car il y a risque d'implosion du tube image. Demandez à un réparateur qualifié de vous en débarrasser.





# Table des matières

## Introduction

Caractéristiques du téléviseur couleur FD Trinitron WEGA® .....	1
Piles pour la télécommande .....	2
À propos de mode d'emploi.....	2
Commandes de menu du panneau avant.....	2







## Raccordement du téléviseur

Panneau arrière du téléviseur .....	3
Raccordements de base .....	4
Raccordement d'autres appareils.....	5

## Utilisation de la télécommande et des fonctions de base

Utilisation de la télécommande.....	13
Réglage automatique du téléviseur .....	14
Accès rapide aux menus.....	15

## Utilisation des menus

Pour accéder à un menu .....	17
Utilisation du menu Vidéo  .....	18
Utilisation du menu Audio  .....	19
Utilisation du menu Réglage des canaux  .....	20
Contrôle parental.....	22
Utilisation du menu Contrôle parental  .....	25
Utilisation du menu Heure  .....	28
Utilisation du menu Réglage  .....	29

## Informations complémentaires

Guide de dépannage.....	31
Spécifications .....	33

<b>Index</b> .....	<b>35</b>
--------------------	-----------



# Introduction

Nous vous remercions d'avoir fait l'achat d'un téléviseur couleur FD Trinitron WEGA® Sony. Avant d'utiliser le présent manuel, vérifiez le numéro du modèle indiqué à l'arrière de votre téléviseur ou sur la page de garde du manuel.

## Caractéristiques du téléviseur couleur FD Trinitron WEGA®

Le téléviseur vous offre, entre autres, les fonctions suivantes :

- ❑ **FD Trinitron ECRAN PLAT**— Tube ultra moderne fournissant une image d'une précision incomparable et une netteté exceptionnelle.
- ❑ **Entrées Y, P<sub>B</sub>, P<sub>R</sub>** — Raccordement d'entrées composante vidéo fournissant une excellente qualité d'image.
- ❑ **Contrôle parental (puce-V)** — Outil aidant les parents à contrôler les émissions que leurs enfants regardent en définissant des limites de classement.
- ❑ **Canaux préférées** — Accès immédiat à vos canaux préférés en appuyant sur une touche.
- ❑ **Energy Star®** — Symbole reconnu d'optimisation de l'énergie.
- ❑ **MTS direct** — Accès direct permettant de modifier le son du téléviseur multi-canal : stéréo, mono ou SAP auto (programme audio secondaire) en appuyant sur une touche.
- ❑ **Menus trilingues** — Sélectionnez les menus en anglais, français ou espagnol.
- ❑ **Commandes du panneau avant** — Permettent d'accéder aux menus d'écran sans la télécommande.
- ❑ **Entrées A/V avant** — Connexion rapide pour les consoles de jeux vidéo, caméscopes, appareils stéréo/mono ou casque.
- ❑ **Silence auto** — Fonction conviviale conçue pour couper automatiquement le son du téléviseur lorsqu'aucun signal n'est reçu.

### Piles pour la télécommande

Insérez deux piles AA (R6) (fournies) dans la télécommande en suivant les instructions de l'illustration ci-dessous.

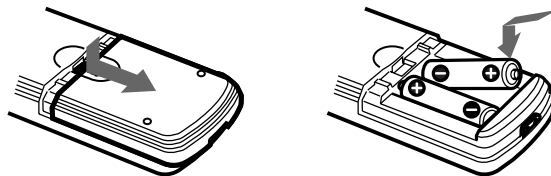

🔧 Dans des conditions d'utilisation normales, les piles durent six mois. Si la télécommande ne fonctionne pas correctement, les piles sont peut-être à plat.

🔧 Si vous n'utilisez pas la télécommande pendant une durée prolongée, retirez les piles afin d'éviter une détérioration éventuelle due à une fuite des piles.

### À propos de mode d'emploi

Ce manuel vous donne des instructions vous permettant de profiter de votre nouveau téléviseur. Il vous indique comment vous raccorder sur une antenne ou un câble, un décodeur, un magnétoscope, un lecteur DVD, un récepteur satellite, un système stéréo ou un caméscope. Lorsque vous avez terminé les raccordements, suivez les instructions et utilisez la télécommande pour accéder aux menus d'écran.

🔧 Les panneaux avant et arrière du téléviseur illustrés dans le présent manuel sont ceux du modèle KV-24FS100. Les panneaux avant et arrière de votre téléviseur peuvent différer légèrement de ceux représentés dans les illustrations.

### Commandes de menu du panneau avant

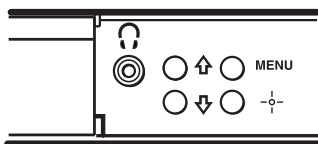

Les commandes du panneau audio/vidéo avant permettent d'accéder au menu sans la télécommande. Appuyez sur <sup>MENU</sup> pour afficher le menu d'écran. Utilisez les touches et du panneau audio/vidéo avant au lieu des touches et de la télécommande. Utilisez la touche du panneau audio/vidéo avant au lieu des touches et de la télécommande. Appuyez de nouveau sur <sup>MENU</sup> lorsque le réglage ou le paramétrage est terminé.

🔧 Reportez-vous à la section " Utilisation des menus ", page 17 pour naviguer entre les menus avec votre télécommande.

# Raccordement du téléviseur

Lisez cette section avant de configurer votre téléviseur pour la première fois. Elle traite les raccordements de base, en plus des appareils en option que vous raccorderez éventuellement.

## Panneau arrière du téléviseur

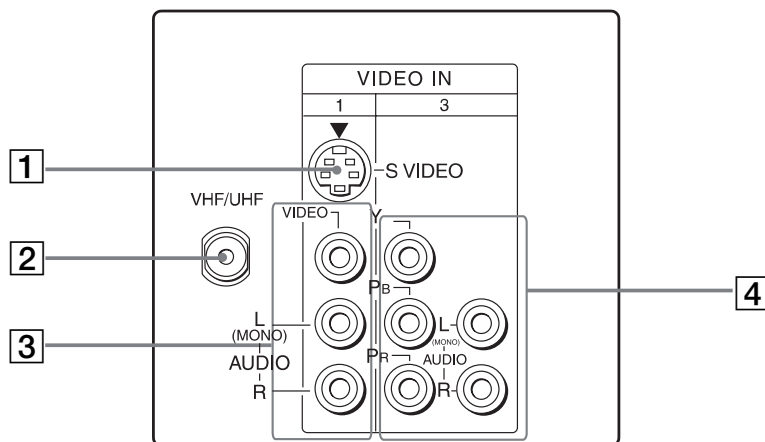

Prise	Description
<b>1 S VIDEO</b>	Se raccorde sur la prise S VIDEO OUT de votre magnétoscope ou d'un autre appareil vidéo possédant une prise S VIDEO. La prise S VIDEO fournit une image de meilleure qualité que les prises VHF/UHF ou que la prise d'entrée vidéo. La prise S VIDEO ne fournit aucun son. Les câbles audio doivent rester raccordés.
<b>2 VHF/UHF</b>	Se raccorde sur votre câble ou antenne VHF/UHF.
<b>3 VIDEO/ AUDIO (L/R)</b>	Se raccorde sur les prises de sortie VIDEO et AUDIO de votre magnétoscope ou d'un autre appareil vidéo. Une troisième prise d'entrée vidéo (VIDEO 2) se trouve sur le panneau avant du téléviseur. Ces prises d'entrée AUDIO/VIDEO fournissent une image de meilleure qualité que la prise VHF/UHF.
<b>4 Y, P<sub>B</sub>, P<sub>R</sub>/ L, R</b>	Se raccorde sur le composant vidéo Y, P <sub>B</sub> , P <sub>R</sub> vers les prises AUDIO L et R de votre lecteur DVD ou décodeur numérique.

 Les panneaux avant et arrière du téléviseur illustrés dans le présent manuel sont ceux du modèle KV-24FS100.



## Raccordements de base

### Antenne de télévision intérieure ou extérieure ou câble CATV

Selon le câble disponible chez vous, choisissez l'un des raccordements suivants :

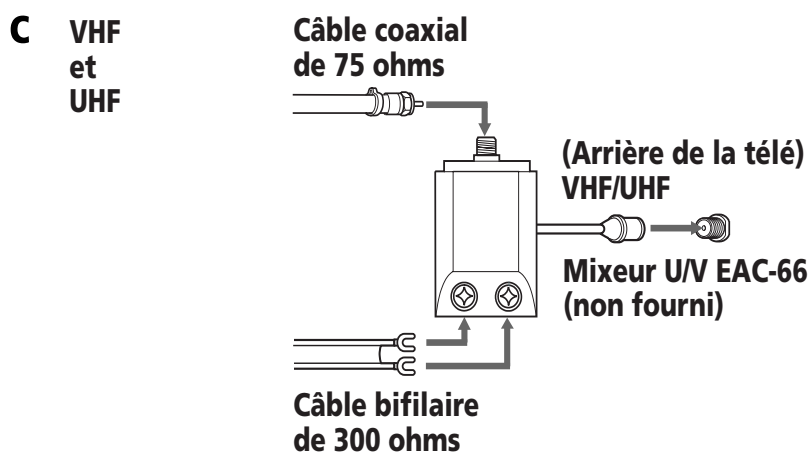
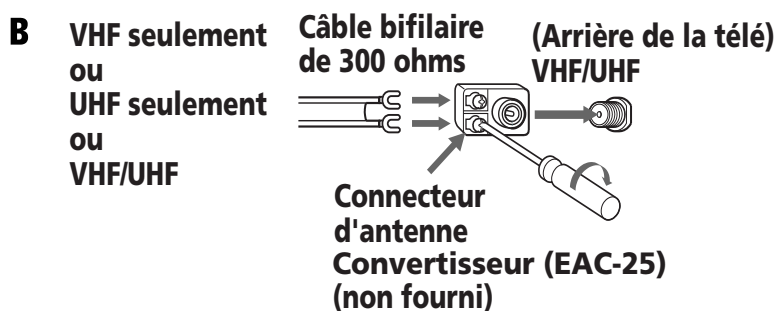
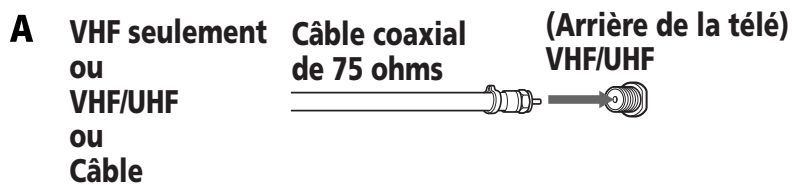

 Si vous vous raccordez sur une antenne intérieure ou extérieure, vous devrez éventuellement ajuster l'orientation de l'antenne pour améliorer la réception.

## Raccordement d'autres appareils

### Téléviseur et magnétoscopes

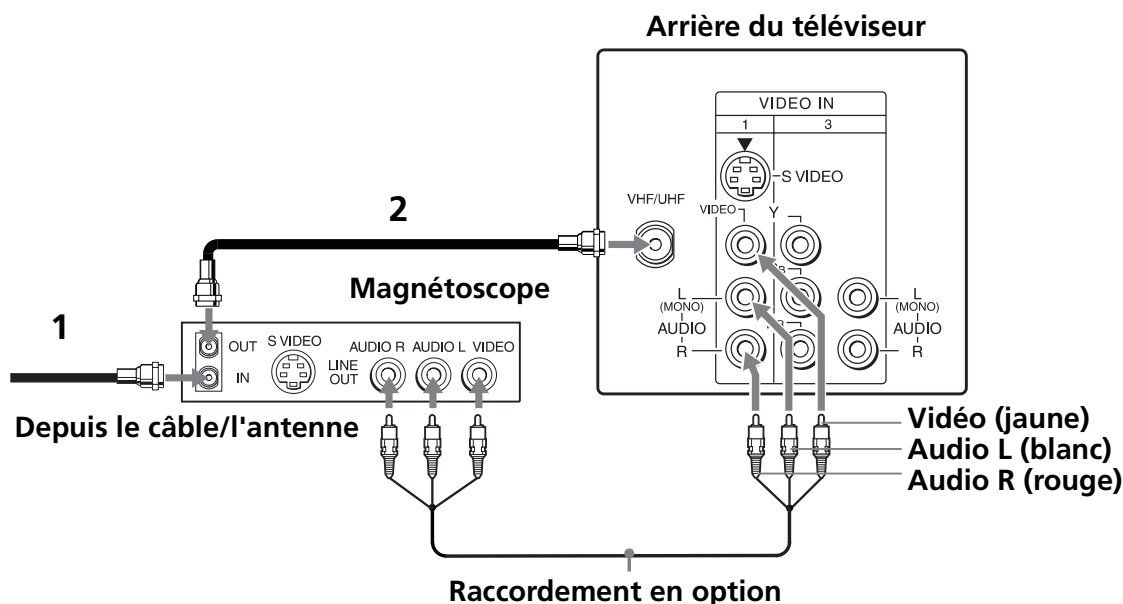

✎ Pour regarder des programmes vidéo depuis le magnétoscope, réglez votre téléviseur sur le canal 3 ou 4 (voir le réglage à l'arrière de votre magnétoscope).

- 1 Raccordez le câble coaxial entre l'antenne de télévision ou le câble et la prise IN du magnétoscope.
- 2 Raccordez un câble coaxial (non fourni) entre la prise OUT du magnétoscope et la prise VHF/UHF du téléviseur.

#### Raccordement en option

Si votre magnétoscope est équipé de sorties vidéo, vous obtiendrez des images de meilleure qualité en raccordant des câbles audio/vidéo (non fournis) entre les prises AUDIO et VIDEO OUT du magnétoscope sur la prise AUDIO/VIDEO IN du téléviseur.

✎ Vous pouvez utiliser la touche  pour basculer entre les entrées VHF/UHF et VIDEO.

✎ Utilisez la prise S VIDEO au lieu du câble audio/vidéo jaune pour obtenir des images de meilleure qualité. La prise S VIDEO ne fournit aucun son. Les câbles audio doivent rester raccordés.

### Téléviseur et décodeur

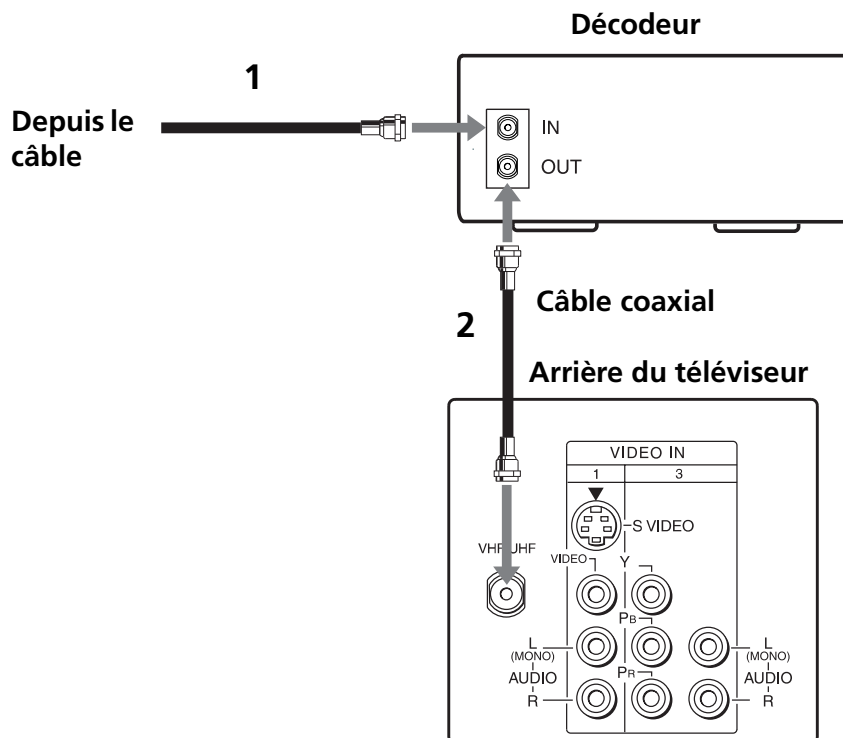

- 1** Raccordez le câble coaxial de votre service du câble sur la prise IN du décodeur.
- 2** Raccordez un câble coaxial (non fourni) entre la prise OUT du décodeur et la prise VHF/UHF du téléviseur.

 Pour regarder des canaux depuis le décodeur, réglez le téléviseur sur le canal 3 ou 4 (voir le réglage à l'arrière de votre décodeur) .

 Si vous effectuez la sélection de tous les canaux via le décodeur, vous devez envisager d'utiliser la fonction Canal fixe en réglant le téléviseur sur le canal 3 ou 4 (voir page 20).

## Téléviseur, magnétoscope et décodeur

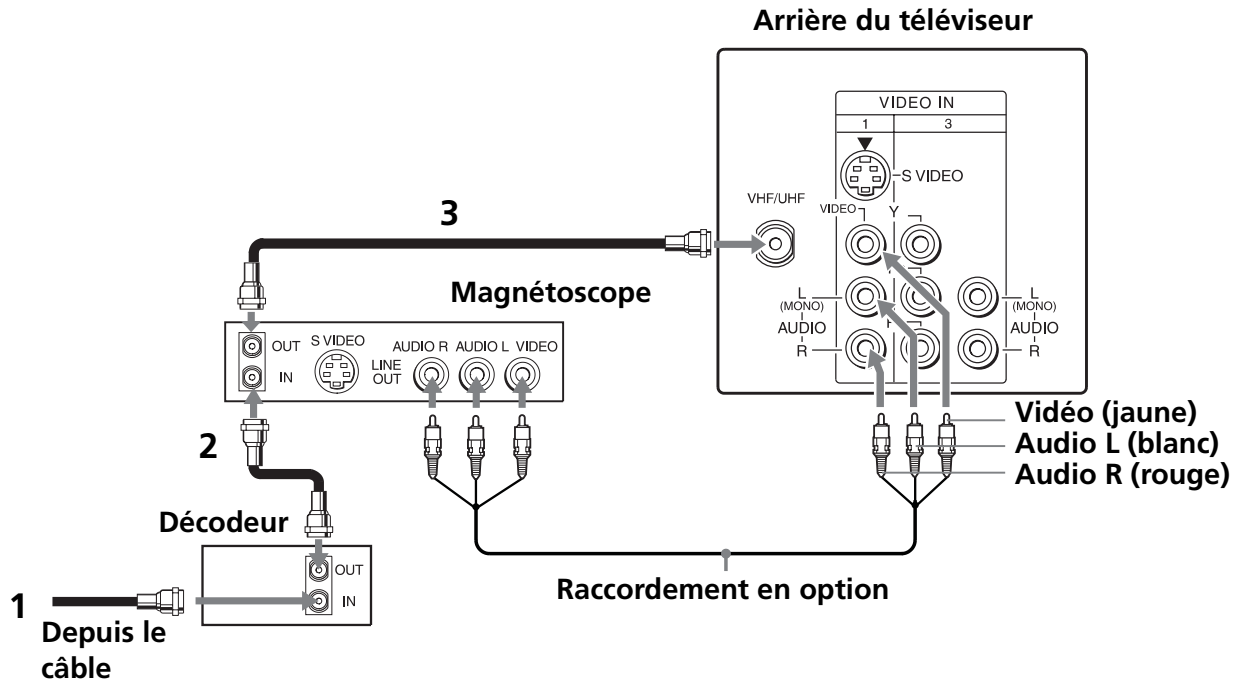

- 1** Raccordez le câble coaxial de votre service du câble sur la prise IN du décodeur.
- 2** Raccordez un câble coaxial (non fourni) entre la prise OUT du décodeur et la prise IN du magnétoscope.
- 3** Raccordez un câble coaxial (non fourni) entre la prise OUT du magnétoscope et la prise VHF/UHF du téléviseur.

Si vous effectuez la sélection de tous les canaux via le décodeur, vous devez envisager d'utiliser la fonction Canal fixe en réglant le téléviseur sur le canal 3 ou 4. (voir page 20).

### Raccordement en option

Si votre magnétoscope est équipé de sorties vidéo, vous obtiendrez des images de meilleure qualité en raccordant des câbles audio/vidéo (non fournis) entre les prises AUDIO et VIDEO OUT du magnétoscope et la prise AUDIO/VIDEO IN du téléviseur.

Vous pouvez utiliser la touche pour basculer entre les entrées VHF/UHF et VIDEO.

Utilisez la prise S VIDEO au lieu du câble audio/vidéo jaune pour obtenir des images de meilleure qualité. La prise S VIDEO ne fournit aucun son. Les câbles audio doivent rester raccordés.

### Téléviseur et récepteur satellite

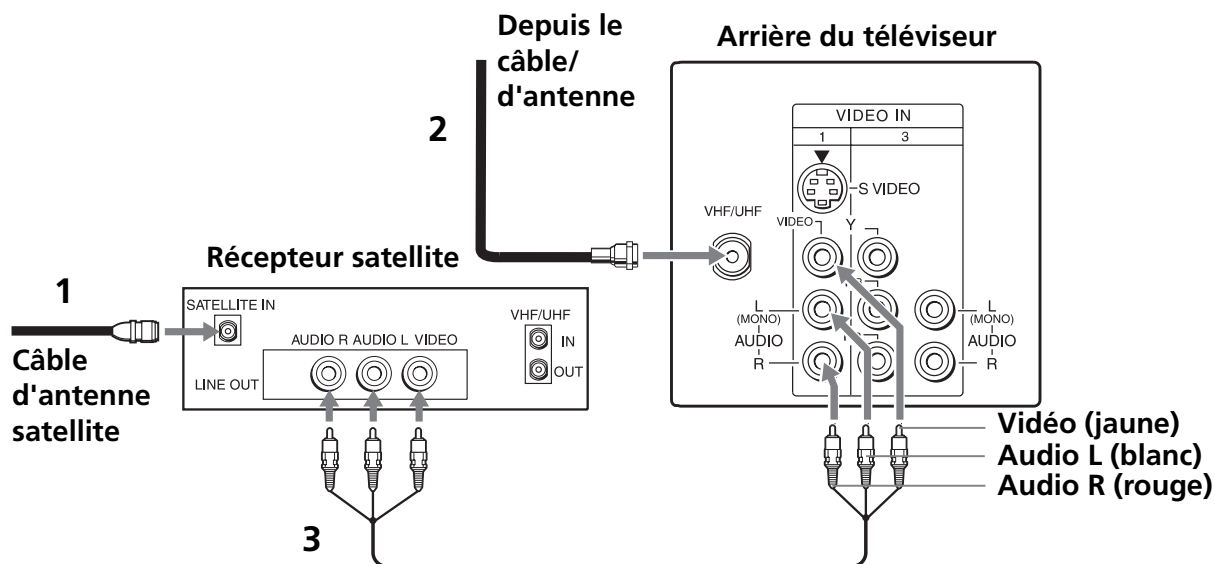

- 1** Raccordez le câble entre l'antenne satellite et la prise SATELLITE IN du récepteur satellite.
- 2** Raccordez le câble coaxial de votre service du câble ou de l'antenne sur la prise VHF/UHF du téléviseur.
- 3** Raccordez les prises AUDIO et VIDEO OUT du récepteur satellite sur les prises AUDIO et VIDEO IN du téléviseur à l'aide de câbles audio/vidéo (non fournis).



Vous pouvez utiliser la touche pour basculer entre les entrées VHF/UHF et VIDEO.

Pour obtenir des images de meilleure qualité, utilisez la prise S VIDEO au lieu du câble audio/vidéo jaune. La prise S VIDEO ne fournit aucun son. Les câbles audio doivent rester raccordés.

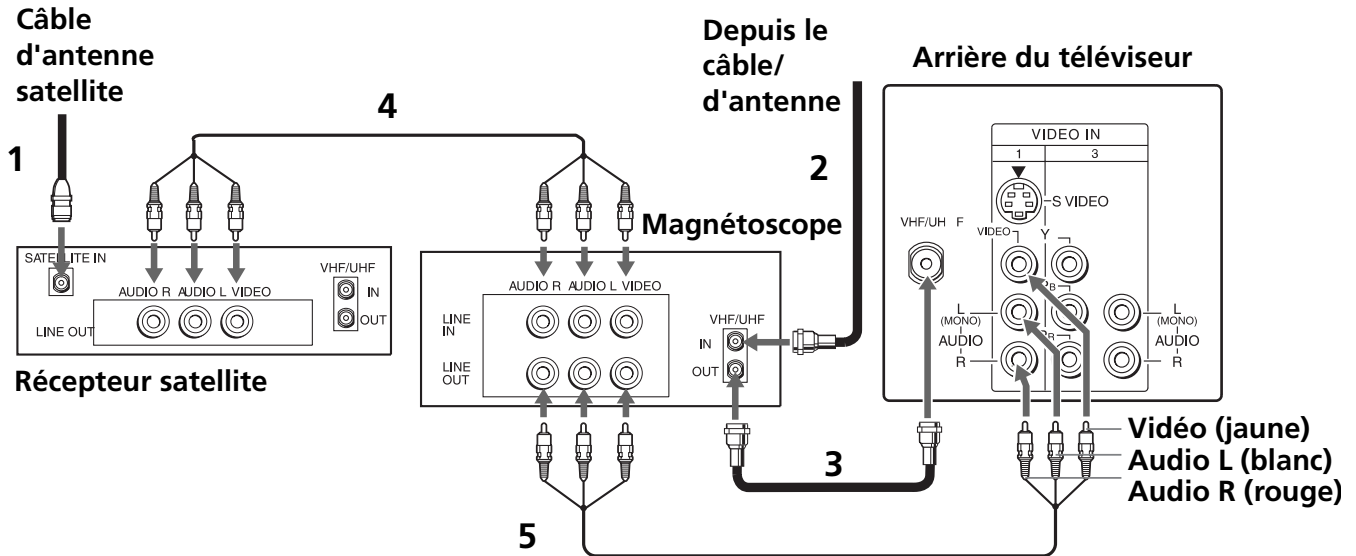
## Téléviseur, récepteur satellite et magnétoscope



- 1** Raccordez le câble entre l'antenne satellite et la prise SATELLITE IN du récepteur satellite.
- 2** Raccordez le câble coaxial de votre service du câble ou l'antenne sur la prise IN du magnétoscope.
- 3** Raccordez la prise OUT du magnétoscope et la prise VHF/UHF du téléviseur à l'aide d'un câble coaxial (non fourni).
- 4** Raccordez les prises AUDIO et VIDEO OUT du récepteur satellite sur les prises AUDIO et VIDEO IN du magnétoscope à l'aide de câbles audio/vidéo (non fournis).
- 5** Raccordez les prises AUDIO et VIDEO OUT du magnétoscope sur les prises AUDIO et VIDEO IN du téléviseur à l'aide de câbles audio/vidéo (non fournis).

 Pour obtenir des images depuis le récepteur satellite ou le magnétoscope, sélectionnez l'entrée vidéo sur laquelle le récepteur satellite ou le magnétoscope est raccordé en appuyant sur la touche  de la télécommande.

## Raccordement d'un lecteur DVD

Raccordez les prises AUDIO et VIDEO OUT du lecteur DVD sur les prises AUDIO et VIDEO IN du téléviseur à l'aide de câbles audio/vidéo (non fournis).

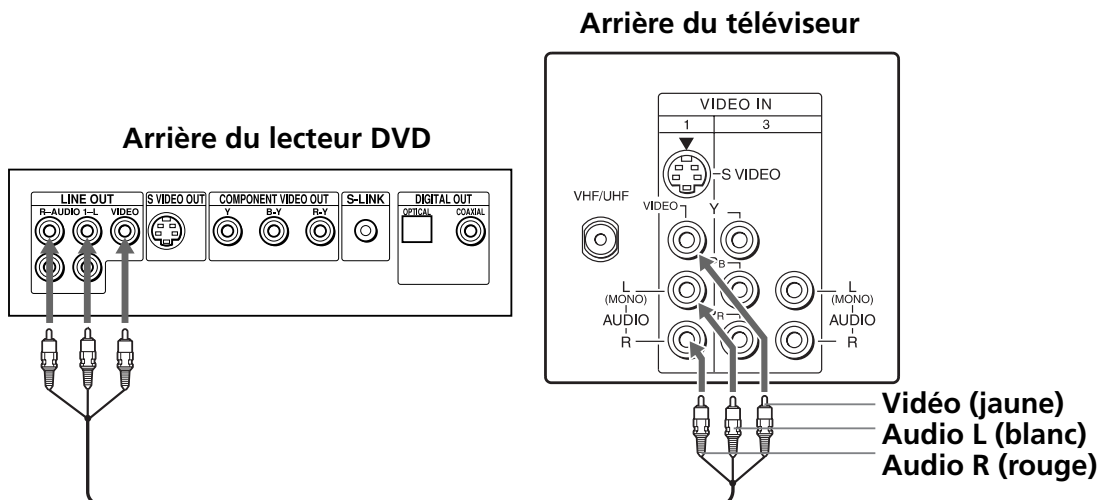

Utilisez la prise S VIDEO au lieu du câble audio/vidéo jaune pour obtenir des images de meilleure qualité. La prise S VIDEO ne fournit aucun son. Les câbles audio doivent rester raccordés.

## Raccordement en option

Si votre lecteur DVD est équipé de sorties composante vidéo (Y, P<sub>B</sub>, P<sub>R</sub>), vous pouvez optimiser la qualité de l'image à l'aide des câbles composante vidéo.

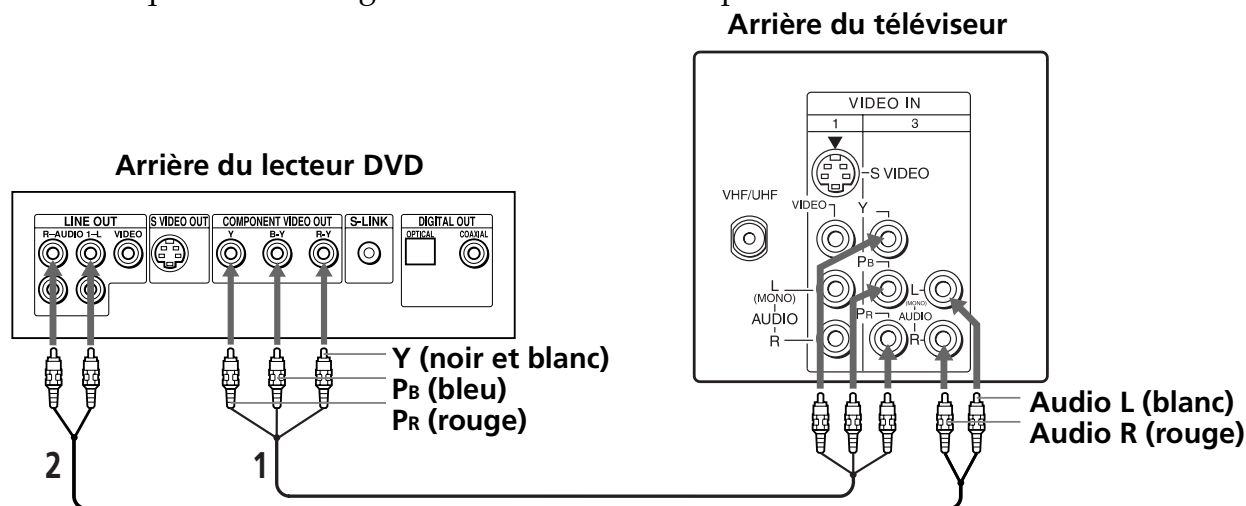

- 1 Raccordez les prises Y, P<sub>B</sub>, P<sub>R</sub> OUT du lecteur DVD sur les prises Y, P<sub>B</sub>, P<sub>R</sub> IN du téléviseur à l'aide de câbles composante vidéo (non fournis).
- 2 Raccordez la prise AUDIO OUT du lecteur DVD sur la prise AUDIO IN du téléviseur.

Les sorties Y, P<sub>B</sub>, P<sub>R</sub> du lecteur DVD sont parfois désignées par Y, C<sub>B</sub> et C<sub>R</sub> ou Y, B-Y et R-Y. Dans ce cas, raccordez les câbles selon les couleurs.

## Raccordement d'un caméscope

Raccordez les prises AUDIO et VIDEO OUT du caméscope sur les prises AUDIO et VIDEO INPUT du téléviseur à l'aide de câbles audio/vidéo (non fournis).

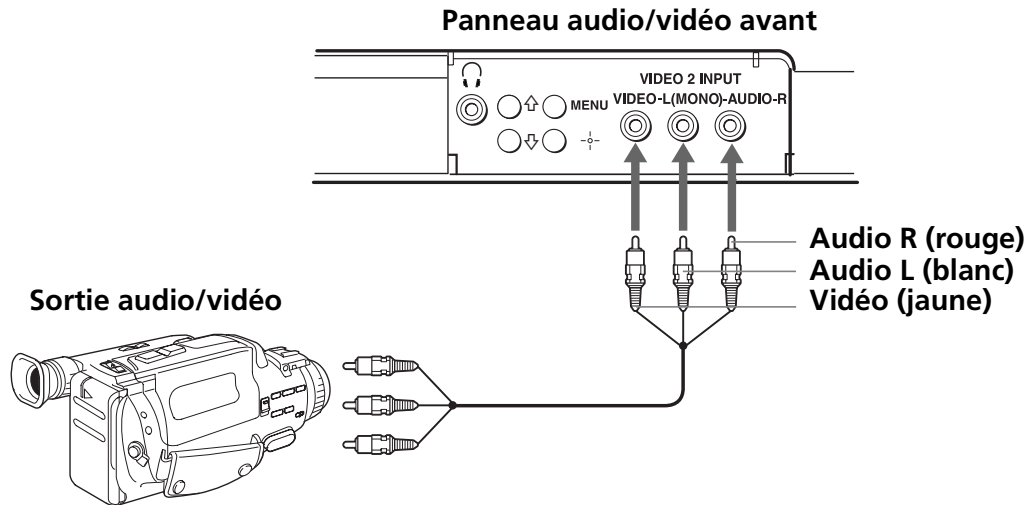

## Raccordement d'un casque

Raccordez le casque sur la prise , à l'avant du téléviseur. La prise des écouteurs est STEREO.

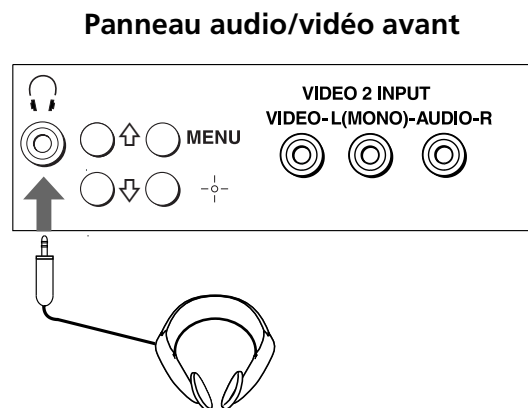



# Utilisation de la télécommande et des fonctions de base

Cette section vous montre comment utiliser les touches de la télécommande et naviguer entre les menus d'écran.

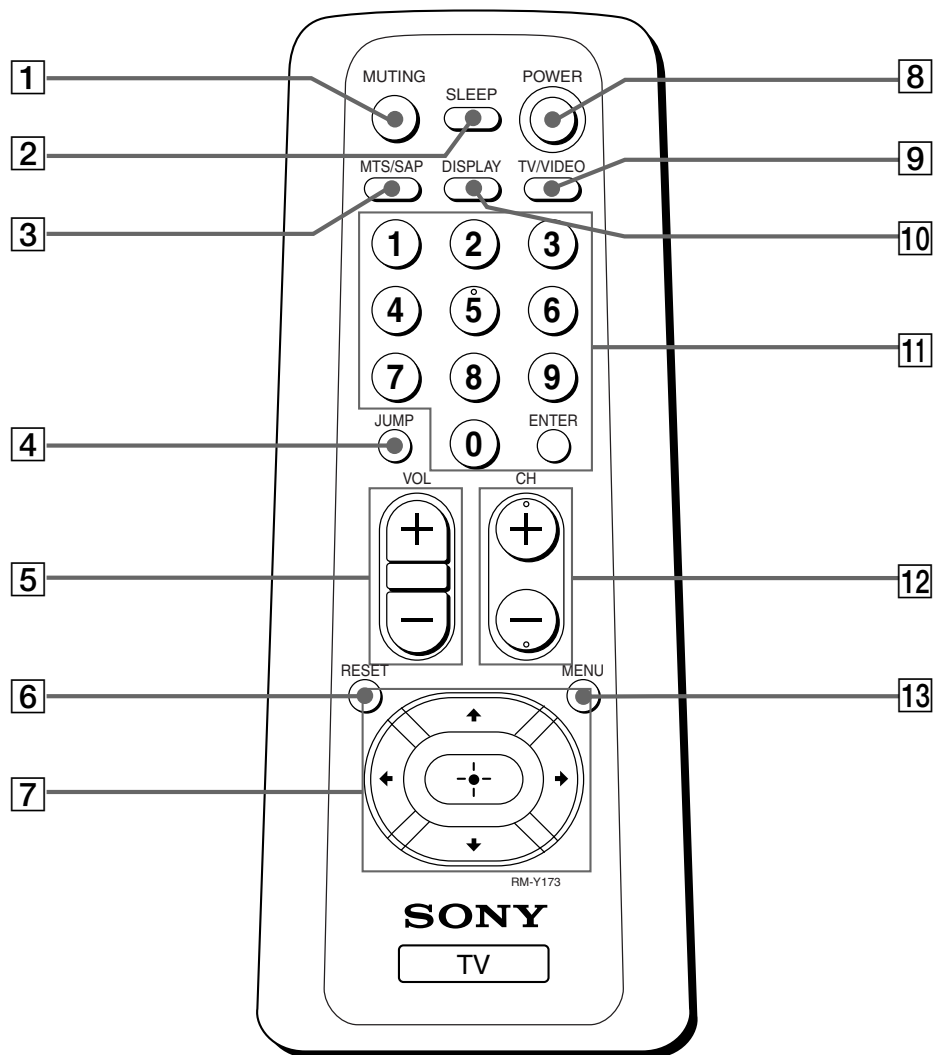

## Utilisation de la télécommande

Touche	Description
<b>1</b> <b>MUTING</b>	Coupe instantanément le son. Appuyez à nouveau sur cette touche ou sur  pour restaurer le son.
<b>2</b> <b>SLEEP</b>	Met le téléviseur automatiquement hors tension après environ 15, 30, 45, 60 ou 90 minutes. Annulez en appuyant sur cette touche jusqu'à ce que SLEEP OFF apparaisse.
<b>3</b> <b>MTS/SAP</b>	Permet de passer d'une option MTS (son de téléviseur multicanal) à une autre: Stéréo, Mono et Auto SAP (émission audio secondaire).
<b>4</b> <b>JUMP</b>	Appuyez sur cette touche pour aller et venir entre deux canaux. Le téléviseur passe alors du canal courant au dernier canal sélectionné.
<b>5</b> <b>VOL (volume)</b>	Appuyez sur cette touche pour régler le volume.
<b>6</b> <b>RESET</b>	Appuyez sur cette touche pour revenir aux réglages par défaut lorsqu'un menu d'écran est ouvert.
<b>7</b> 	Déplace le curseur dans les menus d'écran. Appuyez sur les touches de direction pour déplacer le curseur, puis appuyez sur la touche du milieu pour sélectionner ou ouvrir une option.
<b>8</b> <b>POWER</b>	Appuyez sur cette touche pour mettre le téléviseur sous ou hors tension.
<b>9</b> <b>TV/VIDEO</b>	Navigue entre les entrées vidéo disponibles.
<b>10</b> <b>DISPLAY</b>	Appuyez sur cette touche pour afficher l'heure courante (si elle est réglée) et le numéro de canal. Appuyez à nouveau pour désactiver DISPLAY.
<b>11</b> <b>0-9 et ENTER</b>	Permettent de sélectionner directement le canal souhaité. Appuyez sur les touches <b>0-9</b> pour sélectionner un canal, puis appuyez sur ENTER.
<b>12</b> <b>CH (chaîne)</b>	Appuyez sur cette touche pour changer de chaîne.
<b>13</b> <b>MENU</b>	Affiche le menu d'écran. Appuyez à nouveau sur cette touche pour quitter le menu à tout moment.



 Si vous perdez votre télécommande, reportez-vous à la page 32.

# Réglage automatique du téléviseur

Après avoir procédé au raccordement de votre téléviseur, vous pouvez utiliser la fonction Auto Program pour régler les chaînes.











- 1 Appuyez sur  pour mettre le téléviseur sous tension. L'écran Initial Setup (réglage initial) apparaît.





- 2 Appuyez sur la touche  de la télécommande ou du panneau avant du téléviseur pour exécuter Auto programmation ou appuyez sur  pour quitter.

 L'écran de réglage initial apparaît chaque fois que vous mettez le téléviseur sous tension, jusqu'à ce que la fonction Auto programmation ait été exécutée.

## Pour exécuter Auto programmation

- 1 Appuyez sur .
- 2 Appuyez sur  pour mettre le réglage canal () en surbrillance.
- 3 Appuyez sur  pour mettre Câble en surbrillance. Appuyez sur  pour valider la sélection.
- 4 Appuyez sur  ou  pour sélectionner Oui ou Non selon les raccordements de votre téléviseur. Appuyez sur .
- 5 Appuyez sur  pour mettre Auto programmation en surbrillance. Appuyez sur  pour rechercher les chaînes.

 Lorsque la fonction Auto programmation a été exécutée, appuyez sur  pour quitter.

## Accès rapide aux menus

Les réglages suivants sont disponibles dans les menus d'écran.

### Menu



### Permet de

Procéder aux réglages de l'image.



Modifier les réglages du son.

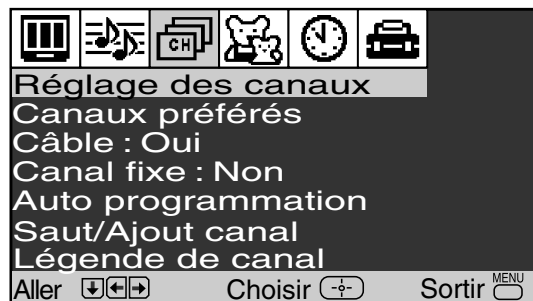

Personnaliser les réglages des chaînes.



Définir des limites de classements sur votre téléviseur en fonction du contenu ou du classement de l'émission.

 Les menus illustrés dans le présent manuel sont ceux du modèle KV-24FS100. Il est possible que vos menus diffèrent de ceux représentés.

### Menu



### Permet de

Réglez l'horloge du téléviseur et programmez avec Minuterie 1 et Minuterie 2.













Sélection des options de sous-titrage, nommez les entrées vidéo, sélectionnez la langue des menus ou lancez la démonstration des menus.

# Utilisation des menus

Cette section traite des options disponibles pour configurer et régler votre téléviseur.

## Pour accéder à un menu

- 1 Appuyez sur  pour afficher le menu d'écran.
- 2 Mettez le menu souhaité en surbrillance à l'aide des touches  ou , puis appuyez sur .
- 3 Mettez l'option souhaitée en surbrillance à l'aide des touches  ou , puis appuyez sur .
- 4 Appuyez sur  pour terminer le réglage ou suivez les instructions affichées à l'écran pour activer l'option souhaitée.
- 5 Appuyez sur  pour quitter le menu.

 Appuyez une fois sur  pour afficher le menu d'écran et appuyez de nouveau pour revenir à une visualisation normale. Si vous n'appuyez sur aucune touche, le menu se ferme automatiquement après 90 secondes environ.

## Utilisation du menu Vidéo

Suivez les étapes suivantes pour accéder au menu Vidéo :



### Réglages image

Lorsque le menu Réglages image est ouvert :

#### Image:

Appuyez sur ⇐ pour réduire le contraste. Appuyez sur ⇒ pour augmenter le contraste.

#### Luminosité:

Appuyez sur ⇐ pour assombrir l'image. Appuyez sur ⇒ pour éclaircir l'image.

#### Couleur:

Appuyez sur ⇐ pour réduire la saturation des couleurs. Appuyez sur ⇒ pour augmenter la saturation des couleurs.

#### Nuance:

Appuyez sur ⇐ pour augmenter les tons rouges. Appuyez sur ⇒ pour augmenter les tons verts.

#### Netteté:

Appuyez sur ⇐ pour atténuer les contours de l'image. Appuyez sur ⇒ pour rendre l'image plus nette.

### Temp. couleur

*Réglage du teint du blanc*

Utilisez les touches ↑ ou ↓ pour sélectionner l'une des options suivantes :

**Froide:** Donne une teinte bleuâtre aux couleurs blanches.

**Neutre:** Donne une teinte neutre aux couleurs blanches.

**Chaude:** Donne une teinte rougeâtre aux couleurs blanches.

### VM

*Modulation de vitesse*

#### **KV-20FS100 et KV-24FS100 uniquement**

Améliore la définition de l'image pour que les contours soient nets.

Utilisez les touches ↑ ou ↓ pour sélectionner l'une des options suivantes :

**Non, Haut, Bas.**

## Utilisation du menu Audio

Suivez les étapes suivantes pour accéder au menu Audio :

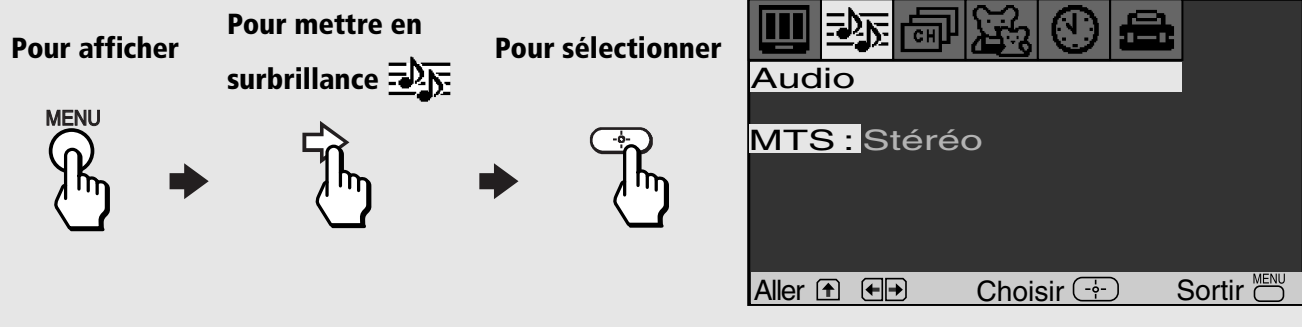

### MTS *Son multi-canal*

Appuyez sur la touche  $\uparrow$  ou  $\downarrow$  pour sélectionner l'une des options suivantes :

**Stéréo:** Sélectionnez cette option pour regarder une émission en stéréo.

**Mono:** Sélectionnez cette option pour réduire les parasites dans les zones où la réception est mauvaise.

**Auto SAP:** Sélectionnez cette option pour que le téléviseur commute automatiquement sur un programme audio secondaire (SAP) lorsqu'un signal est reçu.

 Appuyez sur  $\text{MTS/SAP}$  pour accéder aux réglages MTS (Stéréo, Mono, Auto SAP) directement.



 Si votre téléviseur est réglé sur Auto SAP, le son de certaines émissions risquent d'être coupé ou déformé. Si votre téléviseur n'émet aucun son, passez votre réglage Audio de Stéréo à Mono.



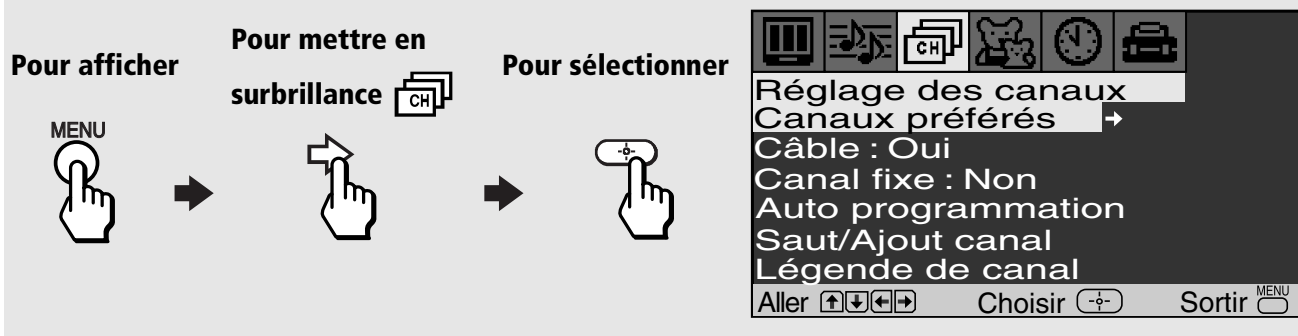

## Utilisation du menu Réglage des canaux

Pour accéder au menu Réglage des canaux, procédez comme suit :



**Pour afficher**  → **Pour mettre en surbrillance**  → **Pour sélectionner** 

**Réglage des canaux**  
**Canaux préférés** →  
 Câble : Oui  
 Canal fixe : Non  
 Auto programmation  
 Saut/Ajout canal  
 Légende de canal  
 Aller  Choisir  Sortir 

### Canaux préférés

*Accès rapide aux chaînes préférées*

Appuyez sur ⇨ pour ouvrir le menu Canaux préférés:

- 1 Sélectionnez la position (1-5) où vous souhaitez régler une chaîne préférée à l'aide des touches ↑ ou ↓, puis appuyez sur ⇨.
- 2 Sélectionnez le canal souhaité à l'aide de la touche ↑ ou ↓.
- 3 Appuyez sur ⇨ pour passer sur le canal sélectionné.
- 4 Appuyez sur ⇩ pour revenir au menu Réglage des canaux ou appuyez sur  pour quitter.

 Pour utiliser la fonction Canaux préférés : quittez tous les menus et appuyez sur ⇨. Appuyez sur ↑ ou ↓ pour déplacer le curseur vers le numéro de chaîne souhaité et appuyez sur ⇨.

### Câble

**Oui:** Sélectionnez cette option si vous recevez des canaux câblées avec un câble CATV.

**Non:** Sélectionnez cette option si vous utilisez une antenne de télévision.

 Vous devez exécuter la fonction Auto Program (programmation automatique) après avoir modifié vos réglages de câble.

### Canal fixe

**2-6:** Sélectionnez cette option pour contrôler toutes les sélections de chaînes via un décodeur ou un magnétoscope. Sélectionnez le canal approprié (en général 3 ou 4) et utilisez la télécommande du décodeur ou du magnétoscope pour sélectionner les chaînes.

**Video 1:** Sélectionnez l'une des entrées vidéo disponibles lorsque vous avez raccordé l'appareil vidéo (par exemple un récepteur satellite) et que vous souhaitez régler le téléviseur en fonction de cet appareil.

**Non:** Canal fixe n'est pas réglé.

### Auto programmation

Appuyez sur ⇨ pour exécuter la programmation automatique.

Exécutez la fonction Auto programmation dès que vous configurez votre téléviseur.

Cette fonction balaie tous les canaux disponibles et programme les chaînes pouvant être reçues.

### Saut/Ajout canal

Utilisez cette fonction après avoir exécuté Auto Programmation pour omettre des chaînes que vous ne souhaitez pas ou en ajouter des nouvelles.

Appuyez sur  $\Rightarrow$  pour ouvrir le menu Saut/Ajout canal :

- 1 Sélectionnez la position de la chaîne souhaitée à l'aide des touches  $\uparrow$  ou  $\downarrow$ , puis appuyez sur  $\oplus$ .
- 2 Sélectionnez Saut ou Ajout à l'aide des touches  $\uparrow$  ou  $\downarrow$ , puis appuyez sur  $\oplus$ .
- 3 Appuyez sur  $\Leftarrow$  pour revenir au menu Réglage des canaux ou appuyez sur  $\text{MENU}$  pour quitter.

 Lorsque vous appuyez sur CH+ ou CH-, les canaux sautés sont ignorés et le canal suivant est sélectionné. Vous pouvez quand même accéder aux canaux ignorés en vous servant des touches ①-⑨.

### Légende de canal

*Permet de nommer 40 chaînes au maximum avec des indicatifs littéraux.*

Appuyez sur  $\Rightarrow$  pour ouvrir le menu Légende de canal:

- 1 Appuyez sur  $\oplus$ , puis sur  $\uparrow$  ou  $\downarrow$  jusqu'à ce que le numéro du canal souhaité soit atteint. Appuyez sur  $\oplus$  pour activer le canal.
- 2 Appuyez sur  $\oplus$ , puis utilisez la touche  $\uparrow$  ou  $\downarrow$  pour afficher le premier nombre ou la première lettre de l'indicatif du titre, puis appuyez sur  $\oplus$  pour le sélectionner. Lorsque la saisie est terminée, appuyez sur  $\oplus$  pour l'activer.

 Les fonctions Canaux préférés, Câble, Saut/Ajout canal et Légende de canal ne peuvent pas être utilisées lorsque Canal fixe est activée.

# Contrôle parental

La fonction Contrôle parental est conçue pour aider les parents à surveiller ce que leurs enfants regardent à la télévision. Cette section montre les différents systèmes de classement disponibles et indique comment régler vos limites de classement pour le téléviseur.

## Aperçu des classements

Lorsque vous vous serez familiarisé avec ces systèmes de classement, vous pourrez régler les limites de classement de votre téléviseur.

## Classement des films

### (modèles destinés aux Etats-Unis uniquement)

Ce système définit les niveaux de classement des films projetés dans les cinémas et sur les principales chaînes du câble.

Classement	Description
G	Tout public
PG	Surveillance parentale conseillée
PG-13	Avertissement fait aux parents
R	Pour adultes seulement
NC-17	Interdit aux moins de 17 ans
X	Interdit aux moins de 17 ans

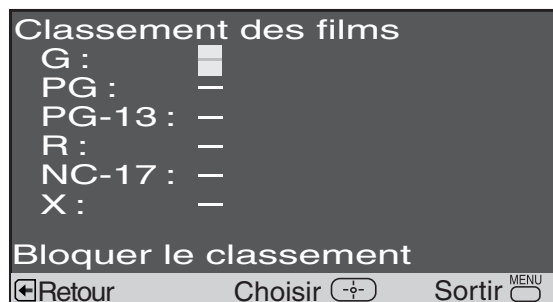

## Classement des émissions de télévision

### (Modèles américains seulement)

Le classement des émissions de télévision est divisé en deux groupes : en fonction de l'âge et en fonction du contenu.

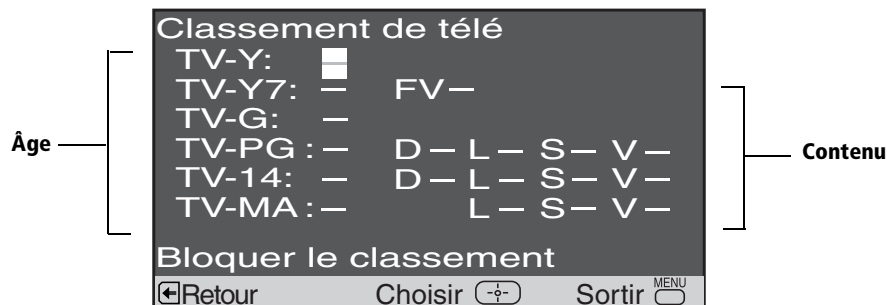

Âge	Description
<b>TV-Y</b>	Tous les enfants
<b>TV-Y7</b>	Pour les enfants plus âgés
<b>TV-G</b>	Tout public
<b>TV-PG</b>	Surveillance parentale conseillée
<b>TV-14</b>	Avertissement adressé aux parents
<b>TV-MA</b>	Pour adultes seulement

Contenu	Description
<b>FV</b>	Fiction Violence
<b>D</b>	Dialogues suggestifs
<b>L</b>	Langage grossier
<b>S</b>	Scènes sexuelles
<b>V</b>	Violence

Les classements du contenu augmentent selon le niveau du classement basé sur l'âge. Par exemple, un émission classée TV-PG V (violence) peut contenir des scènes de violence modérée tandis qu'un classement TV-14 V (violence) peut contenir des scènes très violentes.

## Non classé

### (Modèles américains seulement)

Vous pouvez bloquer des émissions de télévision ou des films qui ne sont pas classés.

<b>Permettre</b>	Autorise toutes les émissions non classées
<b>Bloquer</b>	Bloque toutes les émissions non classées

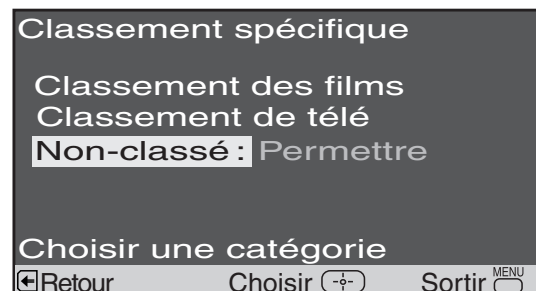

Si vous choisissez de bloquer les émissions de télévision non classées, notez que les émissions suivantes seront également bloquées : bulletins d'informations d'urgence, émissions politiques, sports, actualités, annonce des services publics, émissions religieuses et la météo.

### Classement Anglais

#### (Modèles canadiens seulement)

Ces classements concernent les émissions canadiennes diffusées en anglais.

Classement	Description
C	Enfant
C8+	Enfants de 8 ans et plus
G	Tout publics
PG	Surveillance parentale
14+	Pour les plus de 14 ans
18+	Pour les adultes

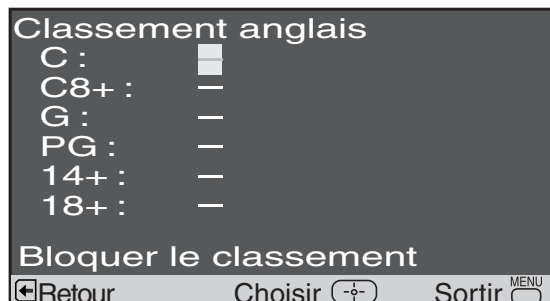

### Classement Français

#### (Modèles canadiens seulement)

Ces classements concernent les émissions canadiennes diffusées en français.

Classement	Description
G	Tout publics
8 ans+	Ne convient pas aux jeunes enfants
13 ans+	Ne convient pas aux enfants de moins de 13 ans
16 ans+	Ne convient pas aux enfants de moins de 16 ans
18 ans+	Émission pour adultes seulement

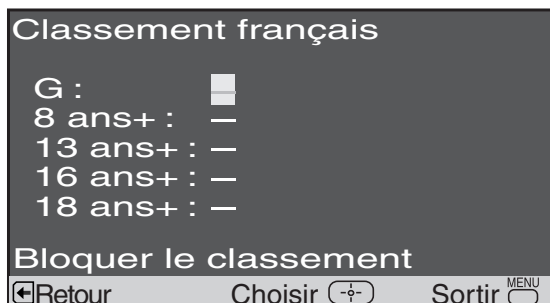

### Classement USA

#### (Modèles canadiens seulement)

Pour les émissions provenant des Etats-Unis, veuillez vous reporter à " Classement des émissions " page 23.

## Utilisation du menu Contrôle parental

Pour accéder au menu Contrôle parental, procédez comme suit :

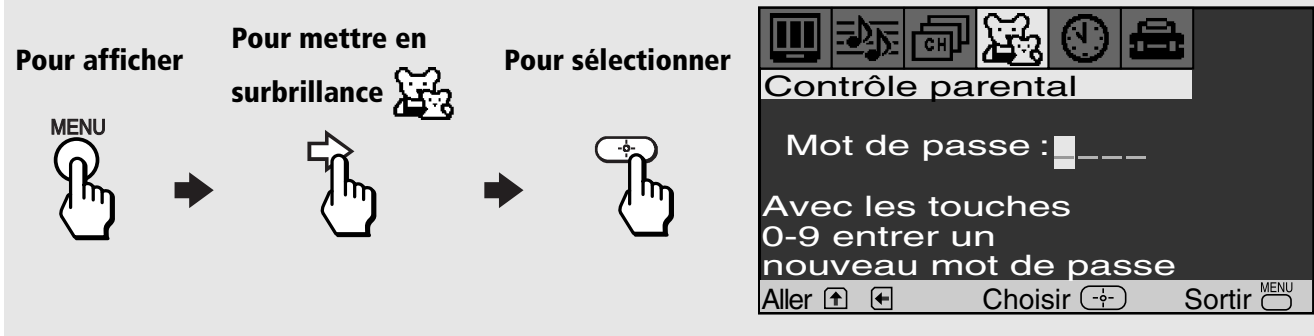

Dans le menu Contrôle parental , il vous sera demandé de définir un mot de passe à 4 chiffres pour tout accès ultérieur à la fonction Contrôle parental.

- 1 Appuyez sur , puis utilisez les touches  pour saisir un mot de passe à 4 chiffres.

 Conservez ce manuel dans un endroit sûr. Si vous oubliez votre mot de passe, reportez-vous à la page 32.

- 2 Confirmez votre mot de passe en le saisissant de nouveau.

Lorsque le mot de passe est réglé correctement, le menu Contrôle parental suivant apparaît.

### Réglage du classement

Vous pouvez modifier le classement en sélectionnant l'une des options de blocage.



**1** Lorsque Lock (blocage) est mis en surbrillance, appuyez sur **[OK]**.

Si vous connaissez mal le système de classement Parental Guidelines (directives de classement des Etats-Unis), utilisez l'une des catégories présélectionnées suivantes pour simplifier les sélections de classement : Enfant, Jeune, Adolescent.

**2** Sélectionnez le classement souhaité à l'aide des touches **[↑]** ou **[↓]**, puis appuyez sur **[OK]**.

Classement	Le téléviseur permet un classement maximum de
Enfant	TV-Y, TV-G, G (modèles américains seulement), G (modèles canadiens seulement)
Jeune	TV-PG, PG (modèles américains seulement), PG (modèles canadiens seulement)
Adolescent	TV-14, PG-13 (modèles américains seulement), 14+ (modèles canadiens seulement)
Spécifique	Sélectionnez cette option pour définir des classements plus restrictifs (voir section suivante)
Non	Pas de restriction d'accès

### Modification du mot de passe

**1** Déplacez le curseur à l'aide des touches **[↑]** ou **[↓]** pour activer Changer le Mot de passe, puis appuyez sur **[OK]**.

**2** Suivez les étapes 1 et 2 de la section " Utilisation du menu Contrôle parental", page 25.

### Information des parents

#### Pour regarder une émission qui sort du classement

Appuyez sur **[ENTER]**, puis utilisez les touches **[0]**-**[9]** pour saisir votre mot de passe.

 La saisie du mot de passe pour la visualisation d'une émission bloquée désactivera provisoirement Lock (blocage). Pour réactiver les réglages classement, mettez le téléviseur hors tension. Lorsque vous mettez le téléviseur sous tension, les réglages classement sont de nouveau activés.

### Utilisation du menu Spécifique

Avant de procéder au réglage des classements Spécifique, reportez-vous aux pages 22-24, "Présentation des classements" donnant une description des systèmes de classements disponibles.

Suivez les instructions affichées à l'écran pour effectuer vos réglages personnalisés. Sélectionnez le pays souhaité pour vos limites de classement des émissions de télévision. Consultez la page 22 pour les modèles destinés aux Etats-Unis et la page 24 pour les modèles destinés au Canada afin d'obtenir plus d'informations.

 Lorsque vous avez bloqué un classement ou un contenu, tous les classements ou contenus supérieurs seront automatiquement bloqués.







# Utilisation du menu Heure

Pour accéder au menu Heure, procédez comme suit :



## Heure







Réglez votre téléviseur à la date et à l'heure actuelles. Appuyez sur  pour ouvrir le menu Heure :

- 1 Entrez la date et l'heure correctes à l'aide des touches  ou , puis appuyez sur .
- 2 Appuyez sur  pour quitter le menu.

 Vous devez régler l'heure actuelle avant d'utiliser les fonctions Minuterie 1 et Minuterie 2.

## Minuterie 1 et Minuterie 2 *Visualisation programmée*

Utilisez ensuite les réglages de la minuterie pour programmer votre téléviseur selon le jour, l'heure, la durée et le canal. La durée maximale du programme de minuterie est de six heures. Lorsque le canal est déjà programmé, il n'est pas nécessaire de régler le canal.

- 1 Sélectionnez Minuterie 1 ou Minuterie 2 à l'aide des touches  ou , puis appuyez sur .
- 2 Appuyez sur  ou  pour saisir le jour, l'heure, la durée et le canal, puis appuyez sur . Une fois son réglage terminé, la minuterie doit être réglée sur Oui.
- 3 Appuyez sur  pour quitter le menu.

 Vous pouvez régler la minuterie sur Oui, Non ou Régler Lorsque la minuterie est réglée, vous pouvez l'activer ou la désactiver sans passer par les réglages. Lorsque Minuterie 1 ou Minuterie 2 est réglé, un voyant rouge situé sur le panneau avant du téléviseur clignote.

 Lorsque vous exécutez Auto Programmation, les réglages Minuterie 1 et Minuterie 2 sont effacés. De même, en cas de coupure d'alimentation, les réglages Heure, Minuterie 1 et Minuterie 2 sont effacés.

## Utilisation du menu Réglage

Pour accéder au menu Réglage, procédez comme suit :

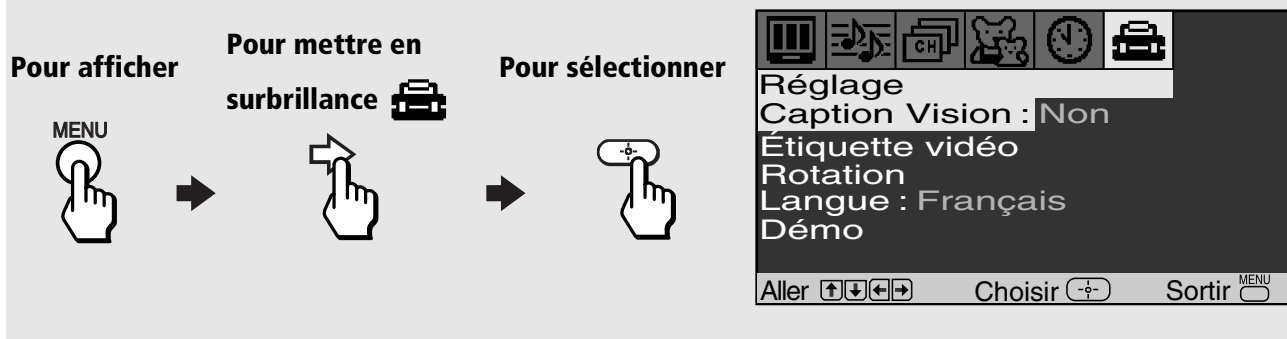

<b>Caption Vision</b>	Permet de sélectionner l'un des trois modes de sous-titrage (pour les émissions diffusées avec l'option sous-titres).
Sous-titrage	Appuyez sur la touche $\uparrow$ ou $\downarrow$ pour sélectionner l'une des options suivantes : <b>CC1, 2, 3, 4:</b> Affiche le dialogue imprimé et les effets sonores d'une émission. <b>Text1, 2, 3, 4:</b> Affiche des informations du réseau/de la station. <b>XDS</b> (services de données étendus): Affiche le nom du programme en cours et son temps restant, si ces informations sont disponibles. <b>Non:</b> Les sous-titres ne sont pas activés.
<b>Étiquette vidéo</b>	Permet de donner un nom aux appareils audio et vidéo raccordés au téléviseur : magnétoscope, lecteur DVD, etc. Ensuite, lorsque vous appuyez sur TV/VIDEO pour changer l'entrée, l'étiquette vidéo de l'appareil sélectionné s'affiche à l'écran. Appuyez sur $\Rightarrow$ pour ouvrir le menu Étiquette vidéo.
<i>Donne un nom aux appareils raccordés</i>	<ol style="list-style-type: none"> <li>Appuyez sur les touches <math>\uparrow</math> ou <math>\downarrow</math> pour accéder à l'entrée que vous souhaitez nommer, puis appuyez sur <math>\oplus</math>.</li> <li>Choisissez un nom à l'aide des touches <math>\uparrow</math> ou <math>\downarrow</math>, puis appuyez sur <math>\oplus</math>.</li> </ol>
<b>Rotation</b>	Appuyez sur $\Rightarrow$ pour ouvrir le menu Rotation : Appuyez sur les touches $\uparrow$ ou $\downarrow$ pour corriger l'inclinaison de l'image sur une plage de - 5 à + 5, puis appuyez sur $\oplus$ pour valider.
<b>Langue</b>	Affiche tous les menus dans la langue de votre choix. Sélectionnez la langue souhaitée à l'aide des touches $\uparrow$ ou $\downarrow$ , puis appuyez sur $\oplus$ .
<b>Démo</b>	Appuyez sur $\oplus$ pour lancer une démonstration des menus d'écran.

 Appuyez sur n'importe quelle touche pour quitter le mode Démo.



# Informations complémentaires

## Guide de dépannage

Si vous rencontrez un problème avec votre téléviseur, essayez d'appliquer les suggestions ci-dessous. Si le problème persiste, contactez votre distributeur Sony.

<b>Aucune image, aucun son</b>	<ul style="list-style-type: none"> <li><input type="checkbox"/> Vérifiez que le cordon d'alimentation est branché.</li> <li><input type="checkbox"/> Si un voyant rouge clignote à l'avant de votre téléviseur pendant plusieurs minutes, débranchez, puis rebranchez le cordon d'alimentation pour réinitialiser le téléviseur. Si le problème persiste, contactez votre service après-vente local.</li> <li><input type="checkbox"/> Vérifiez les réglages TV/VIDEO : réglez sur TV lorsque vous regardez la télévision et réglez sur VIDEO lorsque vous regardez un appareil vidéo (page 13).</li> <li><input type="checkbox"/> Vérifiez que les piles sont insérées correctement dans la télécommande (page 2).</li> <li><input type="checkbox"/> Essayez une autre chaîne, il peut s'agir d'un problème de station.</li> </ul>
<b>Aucune image ou image médiocre, bon son</b>	<ul style="list-style-type: none"> <li><input type="checkbox"/> Réglez l'image dans le menu Réglages image sous Vidéo (page 18).</li> <li><input type="checkbox"/> Réglez la luminosité dans le menu Réglages image sous Vidéo (page 18).</li> <li><input type="checkbox"/> Vérifiez les raccordements de l'antenne et/ou du câble (page 4).</li> </ul>
<b>Bonne image, aucun son</b>	<ul style="list-style-type: none"> <li><input type="checkbox"/> Appuyez sur  de sorte que MUTING disparaisse de l'écran (page 13).</li> <li><input type="checkbox"/> Vérifiez vos réglages du son. Le téléviseur est peut-être réglé sur Auto SAP (page 19).</li> </ul>
<b>Aucune couleur</b>	<ul style="list-style-type: none"> <li><input type="checkbox"/> Réglez la couleur dans le menu Réglages image sous Vidéo (page 18).</li> </ul>
<b>Seule de la neige apparaît sur l'écran</b>	<ul style="list-style-type: none"> <li><input type="checkbox"/> Vérifiez le réglage de l'option Câble dans le menu Réglages des canaux (page 20).</li> <li><input type="checkbox"/> Vérifiez les raccordements de l'antenne et/ou du câble (page 4).</li> <li><input type="checkbox"/> Vérifiez que la chaîne sélectionnée est en cours de diffusion.</li> </ul>
<b>Lignes en pointillés ou rayures</b>	<ul style="list-style-type: none"> <li><input type="checkbox"/> Réglez l'antenne.</li> <li><input type="checkbox"/> Eloignez le téléviseur des autres appareils électroniques. Certains appareils électroniques peuvent créer des parasites électriques susceptibles de perturber la réception du téléviseur.</li> </ul>
<b>Images doubles ou fantômes</b>	<ul style="list-style-type: none"> <li><input type="checkbox"/> Vérifiez votre antenne externe ou contactez votre câblodistributeur.</li> </ul>

---

<b>Impossible de recevoir des canaux dont le numéro est élevé (UHF) avec une antenne</b>	<ul style="list-style-type: none"><li>❑ Vérifiez que l'option Câble est réglée sur Non dans le menu Réglage des canaux (page 20).</li><li>❑ Exécutez la fonction Auto Programmation pour ajouter des chaînes qui ne sont pas enregistrées dans la mémoire (page 14).</li></ul>
<b>Il semble que certaines stations câblées ne fonctionnent pas.</b>	<ul style="list-style-type: none"><li>❑ Vérifiez que l'option Câble est réglée sur Oui dans le menu Réglage des canaux (page 20).</li><li>❑ Exécutez la fonction Auto Programmation pour ajouter des chaînes qui ne sont pas enregistrées dans la mémoire (page 14).</li></ul>
<b>La télécommande ne fonctionne pas</b>	<ul style="list-style-type: none"><li>❑ Il est possible que les piles soient faibles. Remplacez-les (page 2).</li><li>❑ Déplacez le téléviseur à au moins 3-4 pieds des éclairages fluorescents.</li></ul>
<b>Le téléviseur doit être nettoyé.</b>	<ul style="list-style-type: none"><li>❑ Nettoyez le téléviseur avec un chiffon sec et doux. N'utilisez jamais de solvants puissants, comme un diluant ou de la benzine, pouvant endommager le revêtement du châssis.</li></ul>
<b>Oubli du mot de passe du contrôle parental</b>	<ul style="list-style-type: none"><li>❑ Saisissez le mot de passe principal dans l'écran du mot de passe, à savoir 4357. Vous devez créer un nouveau mot de passe après avoir utilisé le mot de passe principal. Il ne peut pas être utilisé pour débloquer des canaux bloqués.</li></ul>
<b>Vous avez perdu votre télécommande</b>	<ul style="list-style-type: none"><li>❑ Les commandes du panneau audio/vidéo avant permettent d'accéder au menu (page 2). Contactez votre distributeur Sony pour commander une télécommande de rechange.</li></ul>

---

*Si vous avez d'autres questions concernant l'utilisation de votre téléviseur Sony après avoir lu le présent mode d'emploi, veuillez contacter notre centre d'assistance Direct Response Center au 1-800-222-SONY (7669) (résidents américains uniquement) ou (416) 499-SONY (7669) (résidents canadiens uniquement).*

## Spécifications

### Pour tous les modèles (sauf mention contraire)

Système de télévision	Standard de télévision américain/NTSC
Couverture des canaux	VHF : 2-13/UHF : 14-69/CATV : 1-125
Antenne	Borne d'antenne externe 75 ohms pour VHF/UHF
Tube cathodique	Tube FD Trinitron®
Alimentation	120 V, 60 Hz
Accessoires fournis	Piles AA (R6) (2) Télécommande RM-Y173 (1)
Accessoires en option	Câbles de liaison VMC-810S/820S, VMC-720M, YC-YC-15V/30V, RK74A Mélangeur U/V EAC-66

#### **KV-13FS100, KV-13FS110**

Taille de l'écran	Taille de l'écran visible : 13 pouces (330 mm) en diagonale Taille réelle de l'écran : 14 pouces (355,6 mm) en diagonale
Entrées/sorties	2 vidéo, 2 audio 1 Y, Pb, Pr, 1 audio 1 prise casque
Sortie du haut-parleur	3 W x 2
Consommation électrique	100 W en fonctionnement 1 W en veille
Dimensions (I/H/P)	407 x 340 x 411 mm (16 x 13 <sup>3</sup> / <sub>8</sub> x 16 <sup>1</sup> / <sub>8</sub> in.)
Poids	12 kg (26 livres 7 onces)

#### **KV-20FS100**

Taille de l'écran	Taille de l'écran visible : 20 pouces (508 mm) en diagonale Taille réelle de l'écran : 21 pouces (533.4 mm) en diagonale
Entrées/sorties	2 vidéo, 2 audio 1 Y, Pb, Pr, 1 audio 1 prise casque
Sortie du haut-parleur	5 W x 2
Consommation électrique	120 W en fonctionnement 1 W en veille
Dimensions (W/H/D)	592 x 466 x 494 mm (23 <sup>1</sup> / <sub>4</sub> x 18 <sup>3</sup> / <sub>4</sub> x 19 <sup>1</sup> / <sub>2</sub> in.)
Poids	24.8 kg (54 livres 10 onces)







## Mode d'emploi

### **KV-24FS100**

Taille de l'écran	Taille de l'écran visible : 24 pouces (610 mm) en diagonale Taille réelle de l'écran : 25 pouces (635 mm) en diagonale
Entrées/sorties	2 vidéo, 2 audio 1 S VIDEO 1 Y, PB, PR, 1 audio 1 prise casque
Sortie du haut-parleur	7.5 W x 2
Consommation électrique	145 W en fonctionnement 1 W en veille
Dimensions (W/H/D)	704 x 524 x 472 mm (27 <sup>3</sup> / <sub>4</sub> x 20 <sup>5</sup> / <sub>8</sub> x 18 <sup>1</sup> / <sub>2</sub> in.)
Poids	35 kg (77 livres 1 onces)

La conception et les spécifications sont sujettes à modification sans préavis.

# Index

- A**
  - Auto programmation 14, 20
  - Auto SAP 19
- C**
  - Canaux préférés 20
  - Caractéristiques du téléviseur 1
  - Couleur 18
  - Câble 20
  - Canal fixe 20
  - Contrôle parental 22
  - Classements
    - Classement anglais 24
    - Classement des émissions de télévision 23
    - Classement des films 22
    - Classement français 24
    - Classement USA 24
    - Non classé 23
  - Caption Vision 29
- D**
  - DISPLAY 13
  - Démo 29
- E**
  - Étiquette vidéo 29
- G**
  - Guide dépannage 31
- H**
  - Heure 28
- L**
  - Langue 29
  - Légende de canal 21
  - Luminosité 18
- M**
  - Menus
    - Audio  19
    - Contrôle parental  25
    - Heure  28
    - Réglage  29
    - Réglage de canaux  20
    - Vidéo  18
  - Minuterie 1 et Minuterie 2 28
- Mise en place des piles 2
- MTS
  - Auto SAP 19
  - Mono 19
  - Stéréo 19
- N**
  - Netteté 18
  - Nuance 18
- P**
  - Panneau avant du téléviseur 2
  - Panneau arrière du téléviseur 3
- R**
  - Raccordements
    - Câble et antenne 4
    - Raccordement d'un caméscope 11
    - Raccordement d'un casque 11
    - Raccordement d'un lecteur DVD 10
    - Téléviseur et décodeur 6
    - Téléviseur et magnétoscope 5
    - Téléviseur, magnétoscope et décodeur 7
    - Téléviseur et récepteur satellite 8
    - Téléviseur, récepteur satellite et magnétoscope 9
  - Rotation 29
- S**
  - Saut/Ajout canal 21
  - SLEEP 13
  - Spécifications 33
  - Stéréo 19
- T**
  - Télécommande 12
- V**
  - VM 18



Sony Corporation Imprimé aux États-Unis



FD Trinitron  
**WEGA**<sup>®</sup>

---

Manual de Instrucciones

**KV-14FV300**  
**KV-21FM100**

Lea este manual antes de operar el producto.



# ADVERTENCIA

Para disminuir el riesgo de incendio o descarga eléctrica, no exponga el televisor a lluvia o humedad.



Este símbolo tiene por objeto advertir al usuario de la presencia de “voltaje peligroso” desprovisto de aislamiento en el interior del producto que puede ser de suficiente magnitud como para presentar un riesgo de descarga eléctrica para las personas.



Este símbolo tiene por objeto advertir al usuario de la presencia de instrucciones importantes de uso y mantenimiento (servicio) en la documentación que acompaña a este aparato.

## Nota para el instalador de CATV

Esta nota pretende llamar la atención del instalador del sistema CATV en relación con el artículo 820-40 de la NEC que proporciona las pautas para una adecuada conexión a tierra y, en particular, especifica que el cable de conexión a tierra debe estar conectado al sistema de toma de tierra del edificio lo más cerca posible de la entrada del cable.

## PRECAUCIONES DE SEGURIDAD

- Utilice el televisor con ca (corriente alterna) como se indica a continuación:
  - ca 120 V                    60 Hz
  - ca 220 V                    50/60 Hz (Chile, Perú, Bolivia)
  - ca 120 - 220 V            50/60 Hz (Argentina)
- Una terminal del enchufe es más ancha que la otra para garantizar la seguridad y solo se podrá introducir en la toma de corriente de una manera (sólo los modelos con ca 120 V). Si no puede insertar completamente el enchufe en la toma, póngase en contacto con su proveedor.
- Si se introduce algún objeto sólido o líquido en el televisor, desconéctelo y haga que sea revisado por personal especializado antes de volver a utilizarlo.

## PRECAUCIÓN

Si utiliza juegos de televisión, ordenadores y productos similares con el televisor, mantenga las funciones de brillo y contraste a una configuración baja. Si una imagen fija (sin movimiento) permanece en pantalla durante un tiempo prolongado con una configuración alta del brillo y el contraste, dicha imagen podría permanecer indefinidamente en la pantalla. Si mira continuamente el mismo canal, los logotipos del mismo podrían quedar impresos en la pantalla del televisor. La garantía no cubre este tipo de marcas porque son el resultado de un uso inadecuado.



**Para reducir el riesgo de descarga eléctrica, no utilice el enchufe polarizado con un cable de extensión, un receptáculo ni otras tomas, a menos que las terminales estén bien insertadas y no queden expuestas.**

 Se advierte que cualquier cambio o modificación que no se apruebe de modo explícito en este manual podría anular su autorización para utilizar este equipo.

## NOTIFICACIÓN

Este equipo se ha probado y cumple con las restricciones de los aparatos digitales de clase B de acuerdo con la sección 15 del reglamento de FCC. Estas restricciones se han diseñado para proporcionar protección contra interferencias nocivas en instalaciones domésticas. Este equipo genera, utiliza y puede irradiar energía de radio frecuencia y si no se instala y utiliza siguiendo las instrucciones, puede provocar interferencias en las radiocomunicaciones. Sin embargo, no se garantiza que no se produzcan interferencias en una instalación determinada. Si el equipo produce interferencias en la recepción de radio y televisión que se pueden determinar conectando y desconectando el equipo, el usuario debería intentar corregir la interferencia siguiendo una o varias de las siguientes medidas:

- Reorientar o cambiar de lugar las antenas receptoras.
- Aumentar la separación entre el equipo y el receptor.
- Conectar el equipo a una toma o a un circuito distinto al que está conectado el receptor.
- Ponerse en contacto con el proveedor o con un técnico con experiencia en radio y televisión para obtener asistencia.

## Protección del televisor

- Para evitar el sobrecalentamiento interno, no obstruya los orificios de ventilación.
- No instale el televisor en un lugar con temperatura elevada, humedad, exceso de polvo o donde puedan producirse vibraciones.

## Nota sobre Caption Vision

Este receptor de televisión proporciona pantalla de televisión con visualización de subtítulos de acuerdo con el punto § 15.119 del reglamento de la FCC.

El uso del televisor con finalidades distintas a la visualización privada de emisiones de programas en UHF o VHF o transmisiones vía cable dirigidas al público en general puede requerir la autorización de la compañía de emisión por cable y/o del propietario del programa.

## Información para el propietario

Los números de serie y modelo están situados en la portada de este manual y en la parte posterior del televisor.

## Marcas comerciales y derechos de autor

ENERGY STAR® es una marca registrada.



En calidad de compañía asociada a ENERGY STAR®, Sony ha determinado que este producto o modelo de producto cumple con las directrices de uso eficiente de energía de ENERGY STAR®.

# Normas importantes sobre seguridad

Para su protección lea completamente las instrucciones y conserve este manual para consultarlo en el futuro. Tenga en cuenta y siga todas las advertencias, precauciones e instrucciones que aparecen en pantalla o que se describen en el manual de instrucciones o de asistencia técnica.

## ADVERTENCIA

Para prevenir daños personales, se aconseja seguir las siguientes precauciones básicas de seguridad durante la instalación, el uso y la reparación del aparato.

## Uso

### Fuentes de alimentación

Este aparato sólo debe utilizarse con la fuente de alimentación que se indica en la placa del número de serie/modelo. Si no está seguro del tipo de alimentación eléctrica que se utiliza en su domicilio, consulte con su proveedor o con la compañía eléctrica local. Para los aparatos alimentados mediante una batería, consulte el manual de instrucciones.

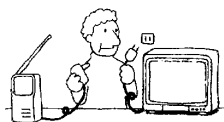

### Conexión a tierra o polarización

Este aparato está equipado con un enchufe de cable de alimentación de ca polarizado (con una terminal más ancha que la otra) o con un enchufe de tres cables de conexión a tierra (con una tercera terminal para la conexión a tierra).

Consulte las siguientes instrucciones.

### Para los equipos con un enchufe de cable de alimentación de ca polarizado

El enchufe se introduce en la toma de corriente en una única dirección. Se trata de una característica de seguridad. Si no puede insertar completamente el enchufe en la toma, intente girar el enchufe. Si sigue teniendo problemas para insertar el enchufe, póngase en contacto con su electricista para que le instale una toma adecuada. No ponga a prueba la finalidad de seguridad del enchufe polarizado forzándolo.

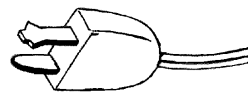

### Advertencia alternativa

#### Para los equipos con un enchufe de ca con tres cables de conexión de tierra

Este enchufe únicamente se acoplará a una toma de corriente de conexión a tierra. Se trata de una característica de seguridad. Si no puede insertar el enchufe en la toma, póngase en contacto con su electricista para que le instale una toma adecuada. No ponga a prueba la seguridad del enchufe de conexión a tierra.

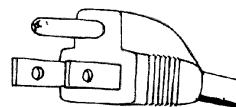

## Sobrecarga

No sobrecargue las tomas de pared, los cables de extensión ni los receptáculos más allá de su capacidad, puesto que podría producirse un incendio o una descarga eléctrica. Apague siempre el televisor cuando no lo utilice. Si no va a utilizar el aparato durante un tiempo prolongado, desconéctelo de la toma de pared como precaución ante la posibilidad de que se produzca un mal funcionamiento interno que pueda provocar un incendio.

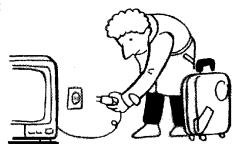
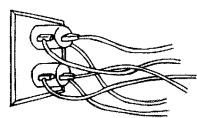

No desconecte la antena ni el cable de alimentación en caso de tormenta. Los relámpagos podrían descargar mientras sujeta el cable y provocarle lesiones graves. Apague el televisor y espere que el tiempo mejore.

## Introducción de objetos y líquidos

No introduzca nunca objetos extraños en el aparato a través de las ranuras de la unidad, puesto que podrían entrar en contacto con puntos de voltaje peligrosos o provocar cortocircuitos de piezas y originar un incendio o descarga eléctrica. Nunca vierta líquidos de ningún tipo en el aparato.



## Accesorios

No utilice accesorios no recomendados por el fabricante ya que podrían ser peligrosos.

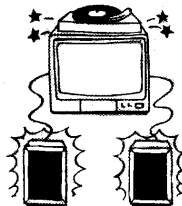

No coloque ningún tipo de objetos, especialmente objetos pesados, encima del aparato. Podrían caerse del aparato y causar lesiones.

## Limpieza

Desconecte el aparato de la toma de pared antes de limpiarlo. No utilice detergentes líquidos ni aerosoles. Utilice un paño ligeramente humedecido con agua para limpiar el exterior del aparato.

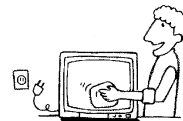

Si se produce un ruido continuo o intermitente en el interior del aparato de televisión mientras está en funcionamiento, desconecte el televisor y póngase en contacto con el proveedor o con el servicio de asistencia técnica. Es normal que algunos aparatos de televisión produzcan ocasionalmente este tipo de ruidos, especialmente cuando se conectan y desconectan.

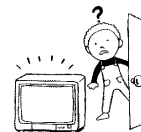

## Instalación

Para levantar o mover el aparato siempre se deberá hacer entre dos o más personas. El aparato es pesado y la superficie inferior es plana. Si intenta mover el aparato sin ayuda o lo manipula de forma insegura, puede producirse lesiones graves. Instale el aparato sobre una superficie plana y estable.

## Agua y humedad

No utilice aparatos de conexión eléctrica cerca de agua, por ejemplo: cerca de la bañera, el lavabo, el fregadero, el lavadero, en un sótano con humedad o cerca de una piscina, etc.

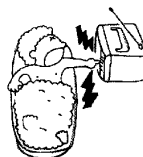

## Colocación

No sitúe el aparato sobre un carro, una mesa pequeña, un tripie, un soporte, una mesa o una estantería inestables. El aparato podría caer y dañarse o bien provocar lesiones graves a niños o adultos. Utilice únicamente carros o mesas recomendados por el fabricante para el modelo específico de televisor. Para el montaje del producto deberán seguirse las instrucciones del fabricante y utilizar los accesorios de montaje recomendados por el mismo. Si se desea mover un aparato colocado encima de un carro, deberá hacerse con cuidado. Las paradas bruscas, la fuerza excesiva y las superficies inestables pueden causar que el aparato y el carro volqueen.

Desconecte todos los cables del aparato antes de intentar moverlo.



No permita que niños o animales se suban encima del aparato o lo empujen. El aparato podría caerse y causar lesiones graves.

## Ventilación

Las ranuras y aperturas en la unidad y en la parte posterior o inferior son para obtener la ventilación necesaria. Para garantizar el buen funcionamiento del aparato y protegerlo de un sobrecalentamiento, estas ranuras y aperturas nunca se deberán obstruir ni cubrir.

- **No cubra nunca las ranuras y aperturas con un paño ni otros tejidos.**

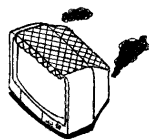

- **No bloquee nunca las ranuras y aperturas situando el aparato encima de una cama, un sofá, una alfombra o superficies similares.**

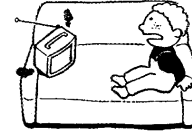

- **No sitúe nunca el aparato en un espacio cerrado, como una biblioteca o un armario empotrado, a menos que exista la ventilación adecuada.**

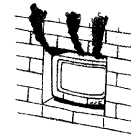

- **No sitúe el aparato cerca o encima de un radiador o fuente de calor ni lo exponga a luz solar directa.**

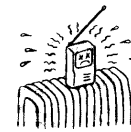

## Protección del cable

No coloque ningún objeto encima del cable de alimentación ni alrededor del mismo, ni sitúe el aparato en un lugar donde el cable de alimentación pueda estar sometido a desgastes o usos no adecuados.

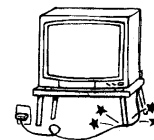



## Conexión a tierra o polarización

Este aparato puede estar equipado con un enchufe de línea de corriente alterna polarizado (con una terminal más ancha que la otra). El enchufe sólo se puede introducir en la toma de corriente en una dirección. Se trata de una característica de seguridad. Si no puede insertar completamente el enchufe en la toma, intente girarlo. Si sigue teniendo problemas para introducir el enchufe, póngase en contacto con su electricista para que sustituya la toma obsoleta. No ponga a prueba la seguridad del enchufe polarizado.

## Antenas

### Conexión a tierra de una antena exterior

Para instalar una antena exterior, siga los procedimientos que se indican a continuación. Los sistemas de antenas exteriores no deben situarse cerca de líneas eléctricas o circuitos de alimentación o luz eléctrica, o bien donde pueda entrar en contacto con dichas líneas eléctricas o circuitos.

**CUANDO INSTALE UN SISTEMA DE ANTENA EXTERIOR, EXTREME LAS PRECAUCIONES Y MANTÉNGALO ALEJADO DE DICHAS LINEAS ELECTRICAS O CIRCUITOS, DADO QUE EL CONTACTO PUEDE RESULTAR FATAL.**

Asegúrese de que el sistema de antena tiene conexión a tierra para proporcionar protección contra los incrementos de voltaje y el aumento de las cargas estáticas. El apartado 810 del Código Eléctrico Nacional (NEC) en EE.UU. y el apartado 54 del Código eléctrico de Canadá proporcionan información relativa a la conexión a tierra adecuada del mástil y de la estructura de soporte, la conexión a tierra del cable de conexión a la unidad de descarga de la antena, el tamaño de los conductores de la conexión a tierra, la ubicación de la unidad de descarga de la antena, la conexión de los electrodos de conexión a tierra y los requisitos de los electrodos de conexión a tierra.

### Conexión a tierra de la antena de acuerdo con la NEC

Conexión a tierra de la antena de acuerdo con el Código Eléctrico Nacional, ANSI/NFPA 70.

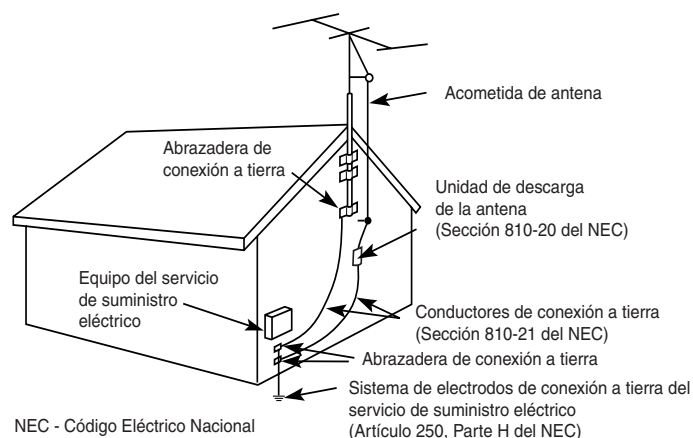

## Rayos

Para mayor protección del receptor de televisión durante una tormenta con rayos o cuando no se utiliza durante largos periodos de tiempo, desconéctelo de la toma de pared y desconecte la antena. Con ello evitará que los rayos y los incrementos de voltaje dañen el receptor.

## Reparación

### Daños que requieren reparación

Desconecte el aparato de la toma de pared y haga que sea revisado por personal calificado cuando se produzcan las siguientes condiciones:

- Si el cable de alimentación o el enchufe están dañados o deshilachados.

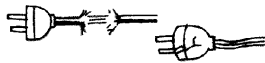

- Si se ha vertido líquido en el interior del aparato o si se han caído objetos en el interior del producto.

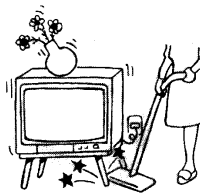

- Si el aparato se ha expuesto a lluvia o agua.



- Si el aparato se ha caído y ha sufrido golpes excesivos o si se ha dañado la unidad.

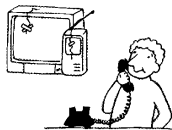

- Si el aparato no funciona con normalidad al seguir las instrucciones del manual. Ajuste solamente los controles que se especifican en el manual de instrucciones. El ajuste inadecuado de otros controles puede provocar daños y a menudo requerirá mucho trabajo por parte de un técnico calificado para restablecer el funcionamiento normal del aparato.



- Si el aparato muestra un cambio de rendimiento significativo, debe repararse.

### Asistencia técnica

No intente reparar usted mismo el aparato, puesto que si abre la unidad puede exponerse a voltajes peligrosos u otros peligros. Ponga cualquier tipo de reparación en manos de personal de asistencia técnica calificado.



### Piezas de reemplazo

Si necesita piezas de reemplazo, asegúrese de que el técnico certifique por escrito que ha utilizado piezas de reemplazo especificadas por el fabricante con las mismas características que las piezas originales. El uso de piezas no autorizadas puede provocar incendios, descargas eléctricas y otros peligros.

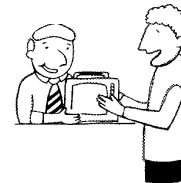

### Comprobación de seguridad

Después de realizar cualquier reparación del aparato, solicite al técnico de la reparación que realice comprobaciones rutinarias de seguridad (como especifica el fabricante) para determinar si el aparato se encuentra en condiciones seguras de funcionamiento y certificarlo. Cuando el aparato llega al final de su vida útil, debe desecharse adecuadamente para evitar una implosión del tubo de la imagen. Consulte a un técnico de reparación calificado para depositar el aparato.





# Contenido

## Introducción

Características del televisor FD Trinitron WEGA® .....	1
Baterías para el control remoto .....	2
Acerca de este manual.....	2
Uso del interruptor MAIN POWER (alimentación principal) del televisor (solamente los modelos KV-14FV300 con destino a Argentina) .....	2
Controles del menú del panel frontal .....	2







## Conexión del televisor

Panel posterior del televisor .....	3
Conexiones básicas .....	4
Conexión de equipo adicional.....	5

## Uso del control remoto y funciones básicas

Uso del control remoto.....	14
Programación automática del televisor .....	15
Acceso rápido a los menús .....	16

## Uso de los menús

Para acceder a un menú .....	19
Uso del menú Video  .....	20
Uso del menú Audio  .....	21
Uso del menú Ajuste de Canal  .....	22
Uso del menú Bloqueo de Canal  .....	24
Uso del menú Timer (Reloj)  .....	25
Uso del menú Ajustes  .....	26

## Información adicional

Solución de problemas .....	27
Especificaciones.....	29

Índice alfabético.....	31
------------------------	----



# Introducción

Gracias por la compra del televisor FD Trinitron WEGA® a color de Sony. Antes de utilizar este manual, verifique el número de modelo situado en la parte posterior del televisor o en la portada de este manual.

## Características del televisor FD Trinitron WEGA®

Algunas de las características de las cuales disfrutará incluyen:

- ❑ **FD Trinitron CRT PLANO** — Nueva pantalla tecnológicamente avanzada para una calidad de imagen óptima.
- ❑ **Entradas Y, P<sub>B</sub>, P<sub>R</sub>**— Conexión de entrada de video para una calidad de imagen superior.
- ❑ **Bloqueo de canales**—Herramienta que permite a los padres bloquear los canales del televisor para controlar los programas que ven sus hijos.
- ❑ **Canales favoritos** — Acceso instantáneo a los canales favoritos con sólo oprimir un botón.
- ❑ **Energy Star®** — Símbolo reconocido de eficacia energética.
- ❑ **MTS Directo** — Permite el acceso directo para cambiar el sonido multicanal del televisor: Estéreo, Mono, o Auto SAP (Segundo Programa de Audio) con sólo oprimir un botón.
- ❑ **Menús trilingües** — Elija los menús en inglés, francés o español (el modelo KV-14FV300 con destino a Argentina, no dispone de menús en francés).
- ❑ **Controles del panel frontal** — Permiten el acceso a los menús de pantalla sin utilizar el control remoto.
- ❑ **Entradas de A/V frontales** — Conexión rápida para videojuegos, cámaras de video, equipos estéreo/mono o audífonos.
- ❑ **Silenciamiento automático** — Función diseñada para silenciar automáticamente el televisor cuando no se reciben señales.

## Baterías para el control remoto

Inserte dos baterías de tipo AA (R6) (incluidas) en el control remoto utilizando como ejemplo la siguiente ilustración

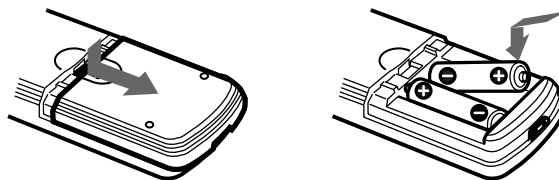

✎ En condiciones de uso normales, las baterías tienen una duración máxima de seis meses. Si el control remoto no funciona correctamente, es posible que las baterías estén gastadas.

✎ Si no va a utilizar el control remoto durante un largo tiempo, extraiga las baterías para evitar posibles daños por fugas de las mismas.

## Acerca de este manual

Este manual proporciona instrucciones para ayudarle a disfrutar de su nuevo televisor. Muestra como conectarlo a la antena o cable, a la caja de cable, a la videograbadora, al DVD, al receptor de satélite o a la cámara de video. Una vez conectado, siga las instrucciones y utilice el control remoto para acceder a los menús de pantalla.









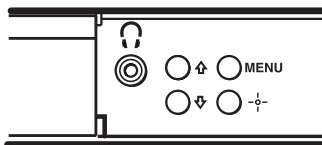

✎ Los paneles frontal y posterior del televisor que se muestran en este manual corresponden a los modelos KV-14FV300. Es posible que los paneles frontal y posterior del televisor no sean exactamente iguales que los que aparecen en las ilustraciones.

## Uso del interruptor MAIN POWER (alimentación principal) del televisor (solamente los modelos KV-14FV300 con destino a Argentina)

Antes de encender el televisor utilizando el control remoto suministrado, oprima , situado en la parte frontal de televisor.

## Controles del menú del panel frontal



Los controles del panel de audio/vídeo frontal le permiten acceder al menú sin el control remoto. Oprima  para que aparezca el menú de pantalla. Utilice los botones  y  del panel de audio/video frontal en lugar de los botones  y  del control remoto. Utilice el botón  del panel de audio/video frontal en lugar de los botones ,  y  del control remoto. Oprima de nuevo  cuando haya completado el ajuste o configuración.

✎ Para navegar por los menús con el control remoto, consulte "Uso de los menús" en la página 19.

# Conexión del televisor

Lea este capítulo antes de instalar el televisor por primera vez. Este capítulo hace referencia a las conexiones básicas, así como a cualquier otro equipo opcional que conecte.

## Panel posterior del televisor

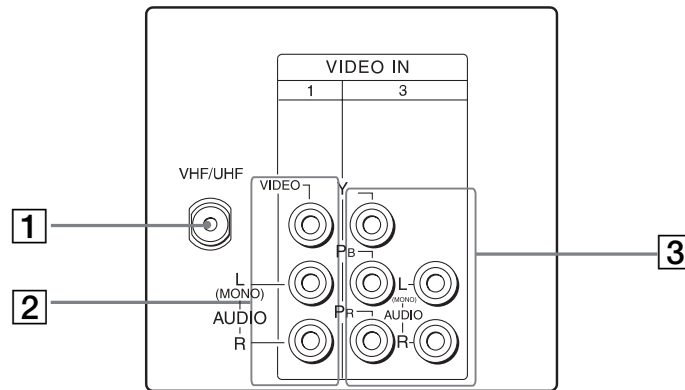

Toma	Descripción
<b>1</b> VHF/UHF	Establece una conexión con el cable o la antena de VHF/UHF.
<b>2</b> VIDEO/ AUDIO (L/R)	Establece una conexión con las tomas de salida de AUDIO y VIDEO de la videograbadora o de otro equipo de video. En el panel frontal del televisor existe una segunda toma de entrada de video (VIDEO 2). Estas tomas de entrada de AUDIO/VIDEO proporcionan una mejor calidad de imagen que la toma VHF/UHF.
<b>3</b> Y, P <sub>B</sub> , P <sub>R</sub> /L, R	Se conectan con las salidas de video (Y, P <sub>B</sub> , P <sub>R</sub> ) y de audio (L/R) de su reproductor de videodiscos o de su caja digital.

Los paneles frontal y posterior que se encuentran ilustrados en este manual corresponden a los modelos KV-14FV300.



## Conexiones básicas

### Televisor con antena interior o exterior o cable CATV

Dependiendo del cable de que disponga, elija una de las siguientes conexiones:

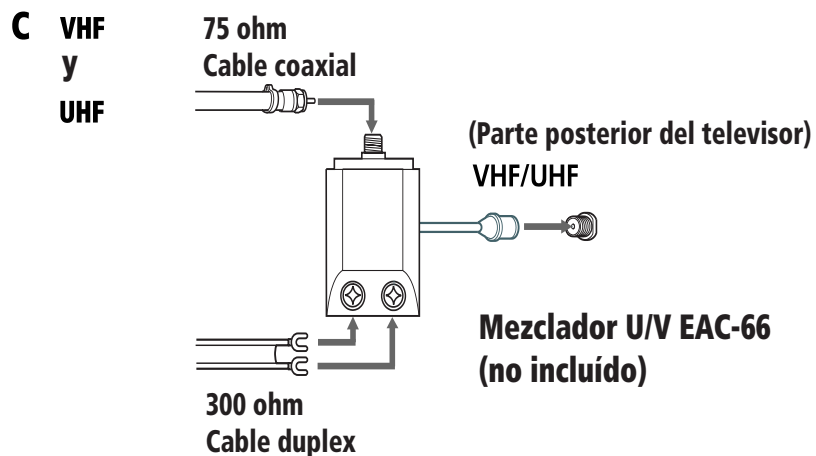
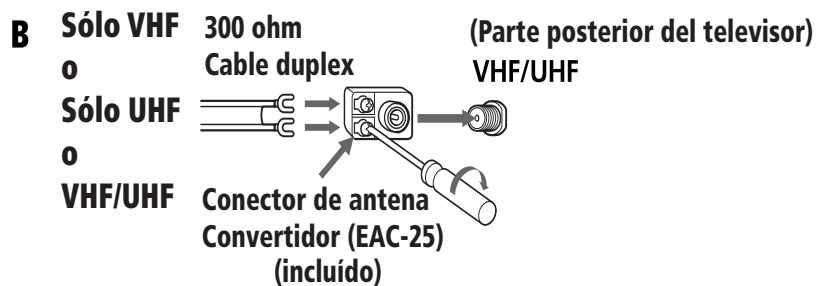
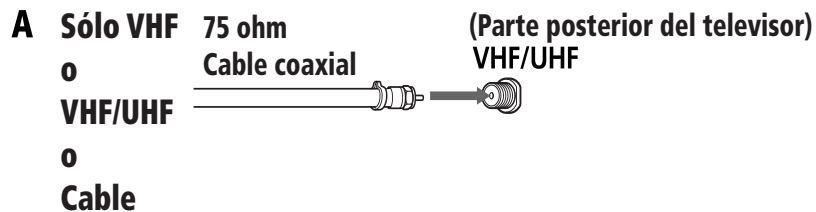

 Si conecta el televisor a una antena interior o exterior, es posible que deba ajustar la orientación de la antena para obtener una mejor recepción.

## Conexión de equipo adicional

### Televisor y videgrabadora

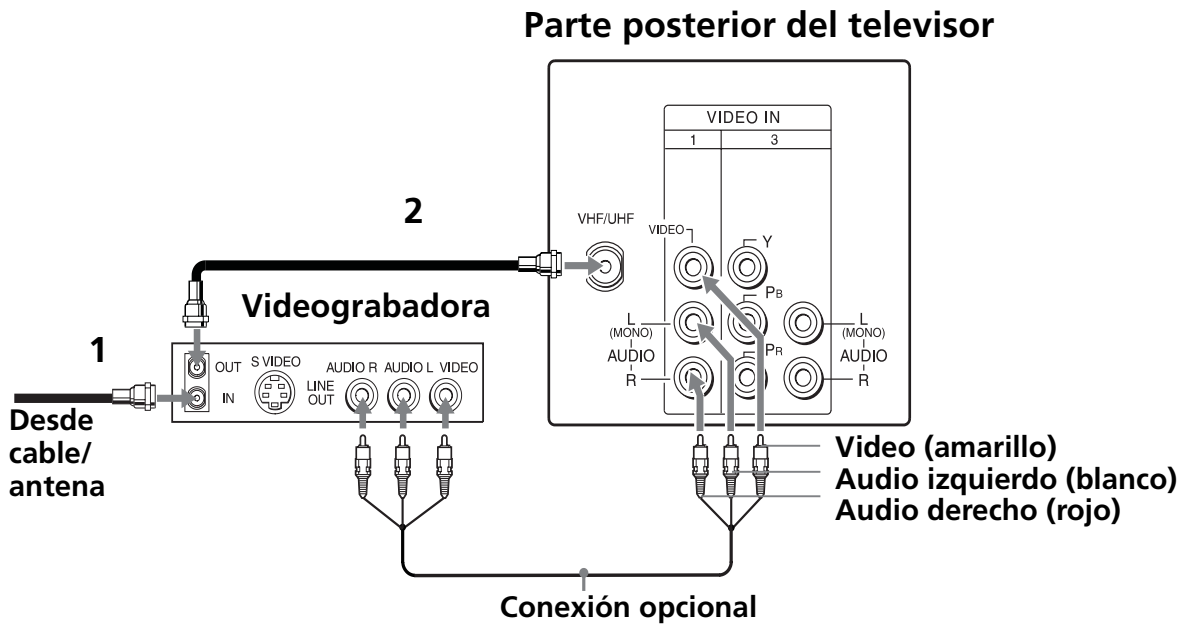

Para ver programas de video desde la videgrabadora, sintonice el televisor en los canales 3 ó 4 (como se indica en la parte posterior de la videgrabadora).

- 1** Conecte el cable coaxial de la antena del televisor o del servicio de cable a la toma IN de la videgrabadora.
- 2** Conecte el cable coaxial (no incluido) de la toma OUT de la videgrabadora a la toma VHF/UHF del televisor.

#### Conexión opcional

Si la videgrabadora dispone de salidas de video, podrá obtener una mejor calidad de imagen conectando los cables de Audio/Video (no incluidos) de las salidas AUDIO y VIDEO OUT de la videgrabadora a la entrada AUDIO/VIDEO IN del televisor.

Puede utilizar el botón para cambiar entre las entradas VHF/UHF y VIDEO.

## Televisor y caja de cable

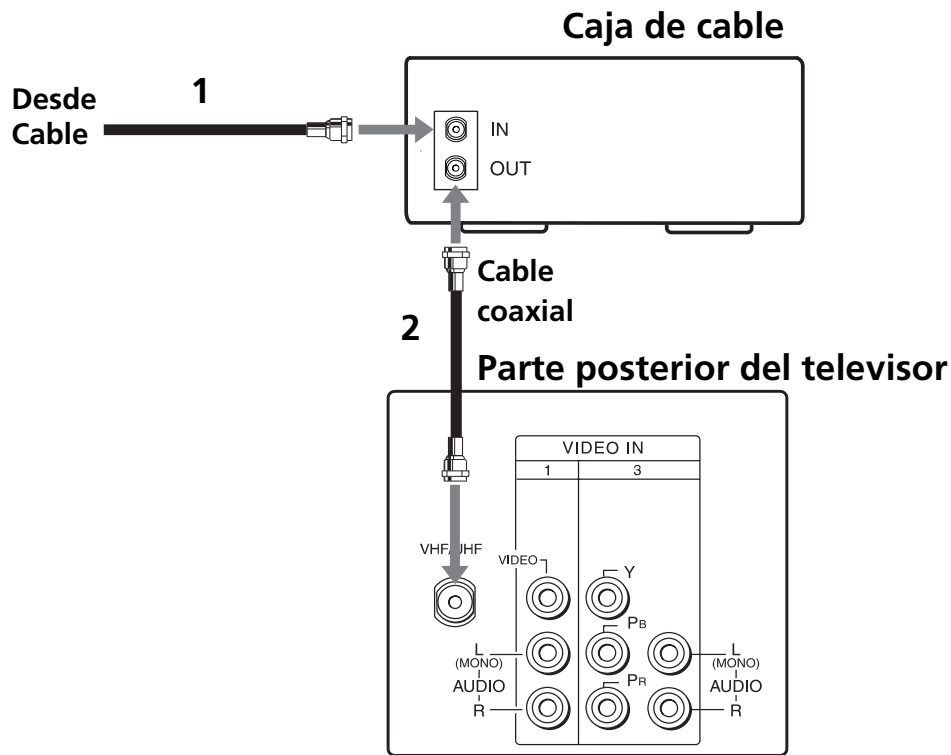

- 1** Conecte el cable coaxial del servicio de cable a la toma IN de la caja de cable.
- 2** Conecte un cable coaxial (no incluido) de la toma OUT de la caja de cable a la toma VHF/UHF del televisor.

 Para ver los canales desde la caja de cable, sintonice el televisor en los canales 3 ó 4 (como se indica en el panel posterior de la caja de cable) y utilice el control remoto de la caja de cable para cambiar los canales.

 Si desea controlar la selección de todos los canales a través de la caja de cable, es aconsejable utilizar la función Fijar Canal ajustando el televisor en el canal 3 ó 4 (consulte la página 22).

## Televisor, videograbadora y caja de cable

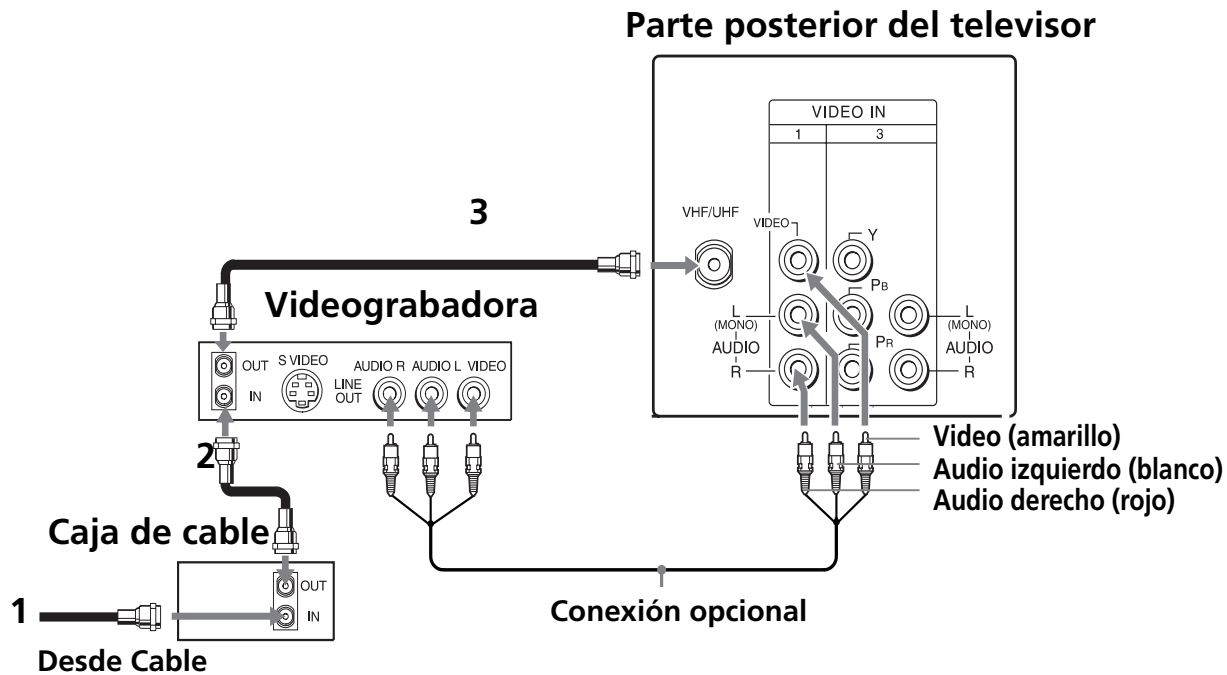

- 1** Conecte el cable coaxial del servicio de cable a la toma IN de la caja de cable.
- 2** Conecte un cable coaxial (no incluido) desde la toma OUT de la caja de cable a la toma IN de la videograbadora.
- 3** Utilizar un cable coaxial (no incluido) desde la toma OUT de la videograbadora a la toma VHF/UHF del televisor.

Si desea controlar la selección de todos los canales a través de la caja de cable, es aconsejable utilizar la función Fijar Canal ajustando el televisor en el canal 3 ó 4 (consulte la página 22).

### Conexión opcional



Si la videograbadora dispone de salidas de video, podrá obtener una mejor calidad de imagen conectando los cables de Audio/Video (no incluidos) desde la salida AUDIO y VIDEO OUT de la videograbadora a la toma de entrada AUDIO/VIDEO IN del televisor.

Puede utilizar el botón para cambiar entre las entradas VHF/UHF y VIDEO.

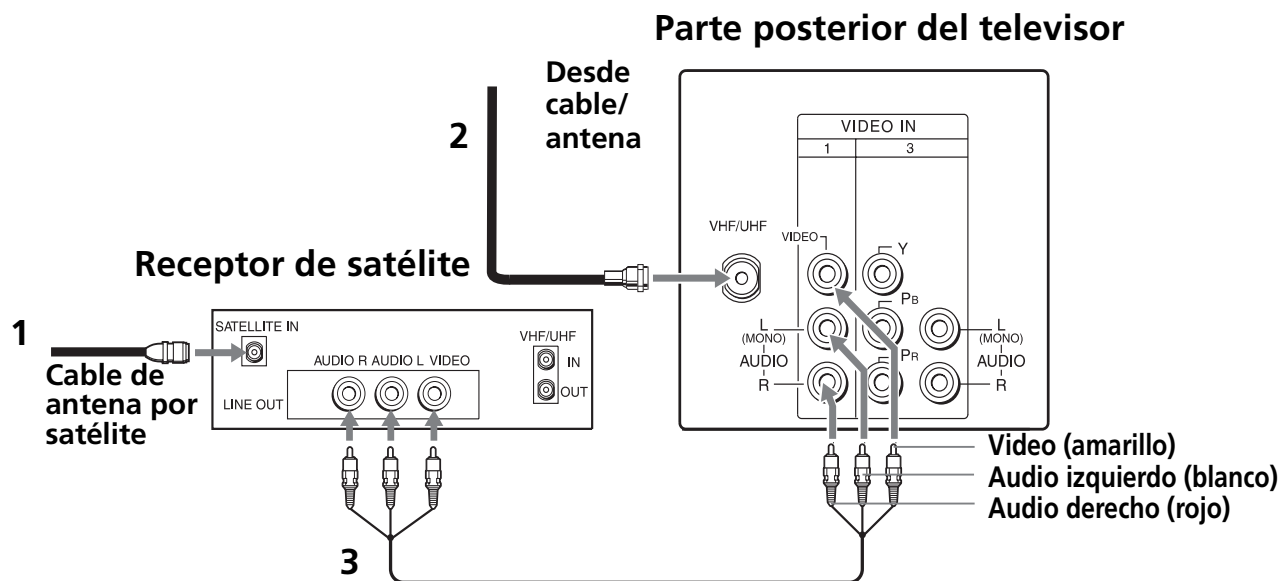
## Televisor y receptor de satélite





- 1 Conecte el cable de la antena por satélite a la entrada SATELLITE IN del receptor de satélite.
- 2 Conecte el cable coaxial del servicio de cables o antena a la toma VHF/UHF del televisor.
- 3 Utilizar cables de Audio/Video (no incluidos), conecte AUDIO y VIDEO OUT del receptor de satélite a AUDIO y VIDEO IN del televisor.

 Puede utilizar el botón  para cambiar entre las entradas VHF/UHF y VIDEO.

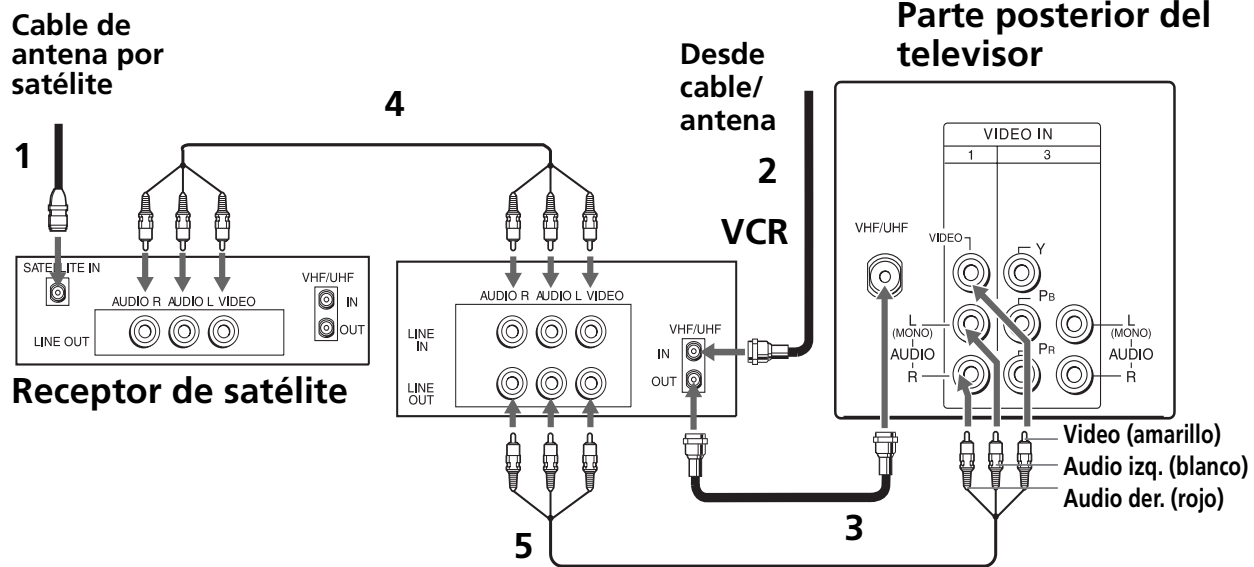
## Televisor, receptor de satélite y videograbadora



- 1** Conecte el cable de la antena por satélite a la entrada SATELLITE IN del receptor de satélite.
- 2** Conecte el cable coaxial del servicio de cable o antena a la toma IN de la videograbadora.
- 3** Conecte la toma OUT de la videograbadora a la toma VHF/UHF del televisor mediante un cable coaxial (no incluido).
- 4** Conecte las tomas AUDIO y VIDEO OUT del receptor de satélite a las tomas AUDIO y VIDEO IN de la videograbadora mediante los cables de Audio/Video (no incluidos).
- 5** Conecte las tomas AUDIO y VIDEO OUT de la videograbadora a las tomas AUDIO y VIDEO IN del televisor mediante los cables de Audio/Video (no incluidos).

 Para visualizar las imágenes desde el receptor del satélite o la videograbadora, seleccione la entrada de video a la que está conectado el receptor de satélite o la videograbadora oprimiendo  en el control remoto.

## Conexión de un reproductor de DVD

Conecte las salidas AUDIO y VIDEO OUT del reproductor DVD a las entradas AUDIO y VIDEO IN del televisor mediante los cables de Audio/Video (no incluidos).

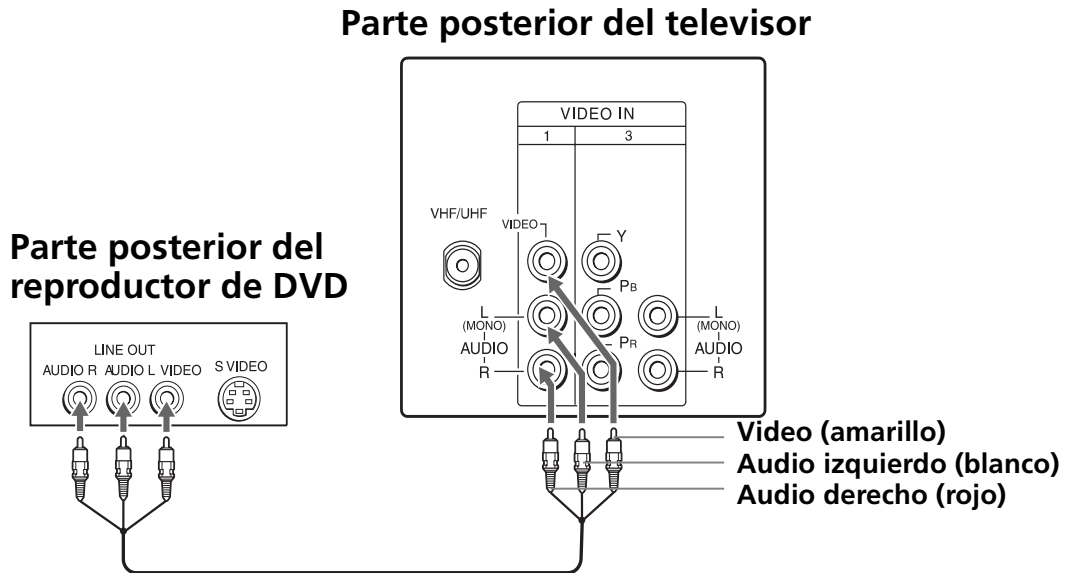

## Conexión de una cámara de video

Conecte las salidas AUDIO y VIDEO OUT de la cámara de video a las entradas AUDIO y VIDEO INPUT del televisor mediante los cables de Audio/Video (no incluidos).

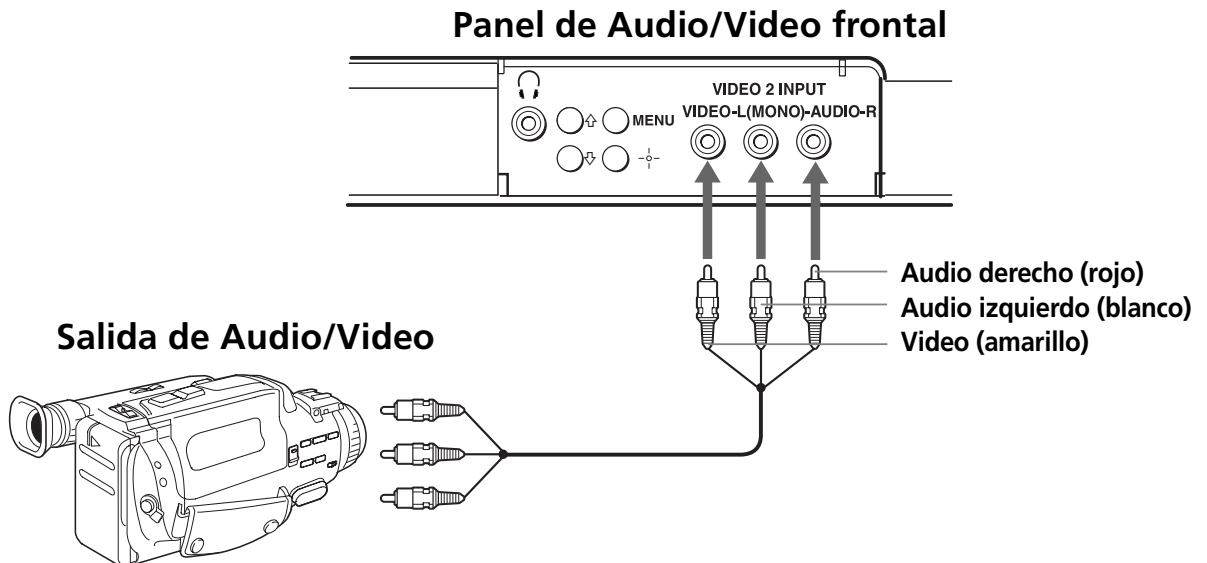

## Conexión de audífonos

Conecte los audífonos a la toma  situada en la parte frontal del televisor.

### Panel de Audio/Video frontal

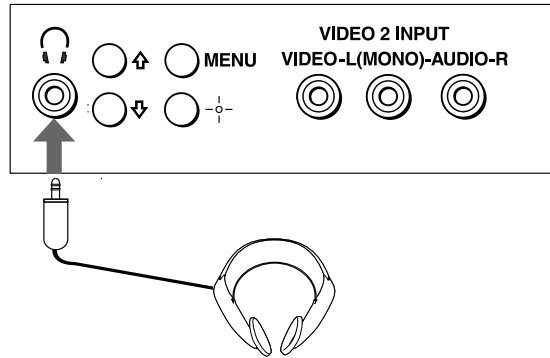





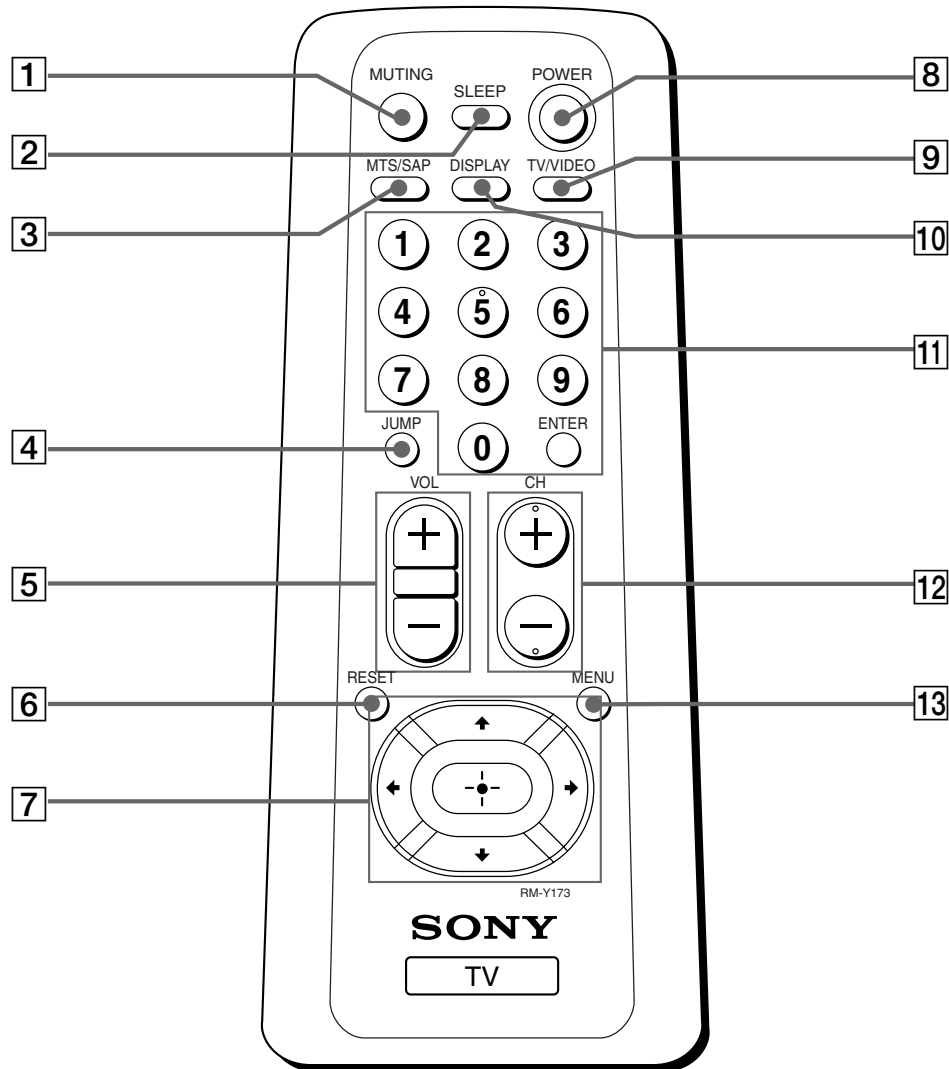

# Uso del control remoto y funciones básicas

Este capítulo muestra cómo utilizar todos los botones del control remoto y los menús de pantalla.



 El control remoto que se muestra (RM-Y173) corresponde a los modelos KV-14FV300. El control remoto que corresponde a los modelos KV-21FM100 no dispone del botón MTS.

## Uso del control remoto

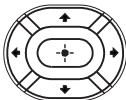
Botón	Descripción
1 <b>MUTING</b>	Desactiva el sonido de forma instantánea. Oprímalo de nuevo u oprima  para restaurar el sonido.
2 <b>SLEEP</b>	Apaga automáticamente el televisor en aproximadamente 15, 30, 45, 60 ó 90 minutos. Para cancelar, oprima hasta que aparezca SLEEP OFF.
3 <b>MTS/SAP</b>	Muestra las distintas opciones de sonido multicanal del televisor (MTS): Estéreo, Mono, y Auto SAP (Segundo Programa de Audio).
4 <b>JUMP</b>	Oprima para alternar entre dos canales. El televisor cambia del canal actual al canal anterior seleccionado.
5 <b>VOL (volumen)</b>	Oprímalo cuando desee ajustar el volumen.
6 <b>RESET</b>	Oprímalo para volver a la configuración de fábrica desde un menú de pantalla.
7 	Mueve el cursor en los menús de pantalla. Oprima los botones de flecha para mover el cursor y a continuación oprima el botón central para seleccionar o acceder a una opción.
8 <b>POWER</b>	Oprímalo cuando desee encender y apagar el televisor.
9 <b>TV/VIDEO</b>	Alterna las entradas de video disponibles.
10 <b>DISPLAY</b>	Oprímalo para mostrar la hora actual (si está ajustada) y el número de canal. Oprímalo de nuevo para desactivar DISPLAY.
11 <b>0-9 y ENTER</b>	Oprima los botones <b>0-9</b> para seleccionar un canal, después oprima ENTER para que cambie de inmediato.
12 <b>CH (canal)</b>	Oprímalo cuando desee cambiar canales.
13 <b>MENU</b>	Muestra el menú de pantalla. Oprímalo de nuevo para salir del menú en cualquier momento.



 Si pierde el control remoto, consulte la página 28.

## Programación automática del televisor

Cuando haya terminado de conectar el televisor, puede ajustar los canales mediante Autoprogramación.

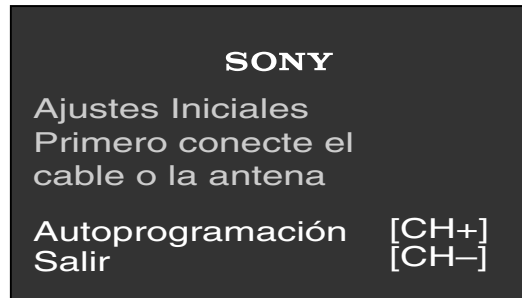









- 1 Oprima  para encender el televisor. Aparecerá la pantalla de Ajustes Iniciales. Para KV-14FV300 con destino a Argentina: Oprima  antes de oprimir  para encender el televisor.





- 2 Oprima  en el control remoto o en el panel frontal del televisor para activar Autoprogramación u oprima  para salir.

 La pantalla de Ajustes Iniciales aparecerá cada vez que encienda el televisor hasta que realice Autoprogramación.

## Para volver a activar Autoprogramación

- 1 Oprima .
- 2 Oprima  para seleccionar Ajuste de Canal (  ).
- 3 Oprima  para seleccionar Cable. Oprima  para seleccionar.
- 4 Oprima  o  para seleccionar Si o No según el estado del televisor. Oprima .
- 5 Oprima  para seleccionar Autoprogramación. Oprima  para buscar los canales.

 Una vez finalizada la función Autoprogramación, oprima  para salir.

## Acceso rápido a los menús

Los ajustes siguientes están disponibles en los menús de pantalla.

### Menú

### Permite



Modificar los ajustes de la imagen.



Cambiar los ajustes de audio.



Personalizar el ajuste de los canales.



Bloquear los canales no deseados.

 Los menús ilustrados en este manual son para los modelos KV-14FV300. Es posible que los menús que usted tiene sean diferentes a éstos.

### Menú



### Permite

Ajustar el reloj del televisor y programar el encendido y apagado automático del televisor en un canal establecido mediante Timer 1 y Timer 2 (Reloj 1 y Reloj 2).











Seleccionar los modos de subtítulos, etiquetar las entradas de video, corregir la inclinación de la imagen, seleccionar el idioma de los menús o ejecutar una demostración de los menús.





# Uso de los menús

Este capítulo muestra las opciones disponibles para configurar y ajustar el televisor.

## Para acceder a un menú

- 1** Oprima  para que aparezca el menú de pantalla.
- 2** Utilice los botones  o  para seleccionar el menú deseado y después oprima .
- 3** Utilice los botones  o  para seleccionar la opción deseada y después oprima .
- 4** Siga las indicaciones que aparecen en pantalla para activar las opciones deseadas. Oprima  para terminar el ajuste.
- 5** Oprima  para salir del menú.

 Oprima  una vez para que aparezca el menú en pantalla, oprima de nuevo para que desaparezca. Si no se oprime ningún botón, el menú se cierra automáticamente transcurridos 90 segundos aproximadamente.



## Uso del menú Video

Para acceder al menú Video, siga los siguientes pasos:



### Control de Imagen

Oprima  para abrir el menú de Control de Imagen:



#### Contraste:

Oprima  para disminuir el contraste. Oprima  para aumentar el contraste.



#### Brillo:

Oprima  para oscurecer la imagen. Oprima  para aumentar el brillo de la imagen.

#### Color:

Oprima  para disminuir la intensidad de color. Oprima  para aumentar la intensidad de color.

#### Tinte:

Oprima  para aumentar los tonos rojos. Oprima  para aumentar los tonos verdes.

#### Nitidez:

Oprima  para suavizar la imagen Oprima  para aumentar la nitidez de la imagen.

### Temperatura del Color

*Ajuste de la tonalidad del blanco*

Oprima  o  para seleccionar una de las opciones siguientes:

**Frío:** Proporciona a los colores blancos una tonalidad azulada.



**Neutro:** Proporciona a los colores blancos una tonalidad neutra.

**Cálido:** Proporciona a los colores blancos una tonalidad rojiza.

### VM

*Modulación de velocidad*

#### Sólo en los modelos KV-21FM100

Aumenta la nitidez de la definición de la imagen y proporciona a los objetos un contorno más nítido y limpio. Oprima  o  para seleccionar una de las opciones siguientes: **No**, **Alto**, **Bajo**.

## Uso del menú Audio

Para acceder al menú Audio, siga los siguientes pasos :

Para mostrar    Para seleccionar     Para seleccionar



The diagram illustrates the steps to access the Audio menu. Step 1: Press the MENU button. Step 2: Press the right arrow button. Step 3: Press the Audio menu icon. The screenshot shows the TV's Audio menu with 'MTS : Estéreo' selected. The bottom of the screen displays navigation controls: 'Mover' with up, down, left, and right arrow keys, 'Seleccionar' with a right arrow key, and 'Salir' with the MENU button icon.

### MTS

*Sonido multicanal del televisor*

### Sólo en los modelos KV-14FV300

Oprima  $\uparrow$  o  $\downarrow$  para seleccionar una de las siguientes opciones:

**Estéreo:** Seleccione esta opción cuando visualice una emisión en estéreo.

**Mono:** Seleccione esta opción para reducir el ruido en zonas de difícil recepción.

**Auto SAP:** Seleccione esta opción para que el televisor cambie automáticamente a Segundo Programa de Audio (SAP) cuando reciba la señal.

 Oprima  $\text{MTS/SAP}$  para acceder directamente a los ajustes de MTS (Estéreo, Mono, Auto SAP).

 Si el televisor está en modo Auto SAP, algunos programas se silenciarán o se distorsionarán. Si el televisor no emite sonido, cambie el ajuste de audio a Estéreo o Mono.

## Uso del menú Ajuste de Canal

Para acceder al menú Ajuste de Canal, siga los siguientes pasos:

Para mostrar



Para seleccionar 



Para seleccionar















### Canales

#### Favoritos

*Acceso rápido a los canales favoritos*

Oprima  para abrir el menú Canales Favoritos:

- 1 Utilice el botón  o  para seleccionar la posición (1-5) donde desea ajustar un canal favorito. A continuación oprima .
- 2 Utilice el botón  o  para seleccionar el canal deseado.
- 3 Oprima  para cambiar al canal seleccionado.
- 4 Oprima  para volver al menú Ajuste de Canal u oprima  para salir.

 Para utilizar Canales Favoritos: Salga de todos los menús y oprima . Oprima  o  para desplazar el cursor al número de canal deseado y oprima .

### Cable

**Si:** Selecciónelo si recibe canales vía cable.

**No:** Selecciónelo si utiliza una antena de televisión.

 Después de cambiar los ajustes del cable, deberá realizar la función Autoprogramación.

### Fijar Canal

**2-6:** Seleccione esta opción cuando desee controlar la selección de todos los canales a través de la caja de cable o de la videograbadora. Seleccione el canal adecuado (normalmente el 3 ó 4) y utilice el control remoto de la caja de cable o de la videograbadora para seleccionar los canales.

**Video 1:** Seleccione esta opción desde las entradas de video disponibles cuando haya conectado el equipo de video (por ejemplo, el receptor de satélite) y desee que quede fijado en el televisor.

**No:** Fijar Canal no está activado.

### Autoprogramación

Realice la función Autoprogramación siempre que ajuste el televisor. Recorrerá todos los canales disponibles y programará los que se reciben.

**Omitir/Añadir Canal**

Utilice esta función después de ejecutar Autoprogramación para omitir los canales no deseados o para añadir nuevos canales. Oprima ⇨ para abrir el menú Omitir/Añadir Canal:

- 1 Utilice los botones ↑ o ↓ para seleccionar la posición del canal deseado y a continuación oprima ⊕.
- 2 Utilice el botón ↑ o ↓ para seleccionar Omitir o Añadir y a continuación oprima ⊕.
- 3 Oprima ⇐ para volver al menú Ajuste de Canal u oprima <sup>MENU</sup> ○ para salir.

 Cuando oprima CH+ o CH- no tendrá acceso a los canales omitidos, sólo a través de los botones ①-⑨ podrá accederlos.

**Nombre del Canal**

*Etiqueta hasta 40 canales con sus letras de llamada*

Oprima ⇨ para abrir el menú Nombre del Canal:

- 1 Oprima ⊕ y a continuación oprima ↑ o ↓ hasta que localice el número de canal deseado.
- 2 Oprima ⊕ para activar el canal.
- 3 Oprima ⊕ y a continuación oprima el botón ↑ o ↓ para mostrar la primera letra de llamada o número de captura y a continuación oprima ⊕ para seleccionarlo. Cuando termine, oprima ⊕ para activar el canal.

 Los modos Canales Favoritos, Omitir/Añadir Canal, Nombre del Canal, Cable y Bloqueo de Canal no se pueden utilizar cuando Fijar Canal está activado o la televisión se encuentra en los modos de video.

## Uso del menú Bloqueo de Canal

Para acceder al menú Bloqueo de Canal, siga los siguientes pasos:

Para mostrar



Para seleccionar



Para seleccionar



 Cuando entre al menú Bloqueo de Canal, el canal seleccionado es el canal que está visualizando.

Con el menú Bloqueo de Canal abierto:

### **Bloquear o Desbloquear**



- 1 Utilice los botones  $\uparrow$  o  $\downarrow$  para elegir el canal deseado y a continuación oprima  $\oplus$  para seleccionarlo.
- 2 Utilice los botones  $\uparrow$  o  $\downarrow$  para bloquear o desbloquear el canal seleccionado y a continuación oprima  $\oplus$ .
- 3 Oprima  $\text{MENU}$  para salir.





 Si un canal está bloqueado, se mostrará una pantalla negra con la palabra "Programa Bloqueado" (solamente para el uso habitual del televisor). La función Bloqueo de Canal se desactiva en los modos de Video.

## Uso del menú Timer (Reloj)





Para acceder al menú Timer (Reloj), siga los siguientes pasos:

Para mostrar      Para seleccionar       Para seleccionar











Mover         Seleccionar       Salir 

**Hora Actual** Muestra el día y la hora actual. Oprima  para abrir el menú de Hora Actual.

- 1 Oprima el botón  o  para introducir el día y la hora correcta y a continuación oprima .
- 2 Oprima  para salir del menú.

 Debe ajustar la Hora Actual antes de poder utilizar Timer 1 y Timer 2 (Reloj 1 y Reloj 2).

**Timer 1 y Timer 2 (Reloj 1 y Reloj 2)** Programa su televisor al día, hora, duración y canal deseado. La programación máxima es de 6 horas. Cuando el canal esté fijado no será necesario introducirlo. Oprima  para abrir el menú de Timer 1 o Timer 2.

- 1 Oprima  o  para seleccionar Timer 1 o Timer 2 (Reloj 1 y Reloj 2) y a continuación oprima .
- 2 Oprima  o  para introducir el día, hora, duración y el canal deseado y a continuación oprima .
- 3 Oprima  para salir del menú.



 Puede fijar Timer en las posiciones Si, No o Ajustar. Cuando Timer 1 y Timer 2 (Reloj 1 y Reloj 2) esté ajustado podrá activarlo y desactivarlo sin tener que revisar los ajustes.

 Al ejecutar Autoprogramación, los ajustes de Timer 1 y Timer 2 (Reloj 1 y Reloj 2) se borrarán. Así mismo, en caso de producirse una pérdida de electricidad, los ajustes de Hora Actual, Timer 1 y Timer 2 (Reloj 1 y Reloj 2) se borrarán.

## Uso del menú Ajustes

Para acceder al menú Ajustes, siga los siguientes pasos:

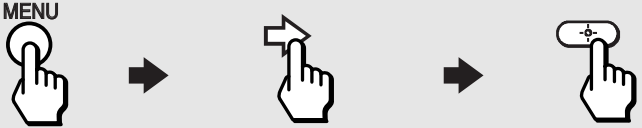
Para mostrar  Para seleccionar  Para seleccionar

**Caption Vision** *Subtítulos* Permite seleccionar tres modos de subtítulos (para programas que se emiten con subtítulos).

Oprima  $\uparrow$  o  $\downarrow$  para seleccionar una de las siguientes opciones:  
**CC1, 2, 3, 4:** Muestra el diálogo impreso y los efectos de sonido de un programa.  
**Text1, 2, 3, 4:** Muestra información sobre la red/emisora.  
**XDS:** Muestra el nombre del programa actual y el tiempo restante, si está disponible.  
**No:** Los subtítulos no están activados.

**Etiqueta de Video** *Etiqueta el equipo conectado* Permite etiquetar los componentes de audio/video que tiene conectado a su televisor: VCR, DVD, etc.

Con la ventana Etiqueta de Video abierta:  
**1** Oprima  $\uparrow$  o  $\downarrow$  para acceder a la entrada que desea etiquetar y oprima  $\ominus$ .  
**2** Oprima  $\uparrow$  o  $\downarrow$  para elegir una etiqueta y oprima  $\ominus$ .

**Rotación** Oprima  $\uparrow$  o  $\downarrow$  para corregir la inclinación de la imagen entre -5 y +5 y a continuación oprima  $\ominus$  para activarla.

**Idioma** Muestra todos los menús en el idioma elegido.  
 Oprima  $\uparrow$  o  $\downarrow$  para seleccionar el idioma deseado (Español, Inglés, Francés) y oprima  $\ominus$ .

**Demo (Demostración)** Oprima  $\ominus$  para ejecutar una demostración de los menús de pantalla.

 Puede oprimir cualquier tecla para salir del modo Demo (Demostración).

**Sistema de Color** **Sólo en los modelos KV-14FV300 con destino a Argentina**  
 Seleccione las configuraciones siguientes para las entradas TV, Video 1 y Video 2: AUTO, NTSC, PAL-M, PAL-N.

# Información adicional

## Solución de problemas

Si tiene problemas con el televisor, intente seguir las indicaciones que se sugieren a continuación. Si el problema persiste, consulte con su proveedor Sony más cercano.

<b>No hay imagen ni sonido</b>	<ul style="list-style-type: none"><li><input type="checkbox"/> Asegúrese que el cable de alimentación esté conectado.</li><li><input type="checkbox"/> Si hay una luz roja que parpadea en la parte frontal del televisor durante algunos minutos, desconecte y vuelva a conectar el cable de alimentación para restaurar el televisor. Si el problema persiste, llame al servicio técnico local.</li><li><input type="checkbox"/> Compruebe los ajustes TV/VIDEO: cuando utilice el televisor, ajústelos en TV; cuando utilice el equipo de video, ajústelo en VIDEO (página 14).</li><li><input type="checkbox"/> Asegúrese de que las baterías están insertadas correctamente en el control remoto (página 2).</li><li><input type="checkbox"/> Inténtelo con otro canal; podría ser problema de la emisora.</li></ul>
<b>Imagen de baja calidad o sin imagen, buen sonido</b>	<ul style="list-style-type: none"><li><input type="checkbox"/> Ajuste Contraste en la opción Video del menú Control de Imagen (página 20).</li><li><input type="checkbox"/> Ajuste Brillo en la opción Video del menú Control de Imagen (página 20).</li><li><input type="checkbox"/> Compruebe las conexiones de la antena y/o del cable (página 4).</li></ul>
<b>Buena imagen, sin sonido</b>	<ul style="list-style-type: none"><li><input type="checkbox"/> Oprima  para que desaparezca MUTING de la pantalla (página 14).</li><li><input type="checkbox"/> Compruebe los ajustes de audio. Es posible que el televisor esté ajustado en Auto SAP (sólo en los modelos KV-14FV300) (página 21).</li></ul>
<b>Sin color</b>	<ul style="list-style-type: none"><li><input type="checkbox"/> Ajuste Color en la opción Video del menú Control de Imagen (página 20).</li></ul>
<b>Sin señal</b>	<ul style="list-style-type: none"><li><input type="checkbox"/> Compruebe el ajuste del cable en el menú Ajuste de Canal (página 22).</li><li><input type="checkbox"/> Compruebe las conexiones de la antena y/o del cable (página 4).</li><li><input type="checkbox"/> Asegúrese de que el canal seleccionado esté emitiendo.</li></ul>
<b>Líneas de puntos o rayas</b>	<ul style="list-style-type: none"><li><input type="checkbox"/> Ajuste la antena.</li><li><input type="checkbox"/> Aparte el televisor de cualquier otro equipo electrónico. Algunos equipos electrónicos pueden crear ruidos eléctricos que interfieran con la recepción del televisor.</li></ul>
<b>Imágenes dobles o fantasmas</b>	<ul style="list-style-type: none"><li><input type="checkbox"/> Revise la antena exterior o llame al servicio técnico del cable.</li></ul>



<b>No se reciben canales con un número alto (UHF) cuando se utiliza una antena</b>	<ul style="list-style-type: none"><li><input type="checkbox"/> Asegúrese de que Cable esta en la posición No en el menú Ajuste de Canal (página 22).</li><li><input type="checkbox"/> Ejecute Autoprogramación para añadir canales que actualmente no estén en la memoria (página 15).</li></ul>
<b>Las emisoras del cable parece que no funcionan</b>	<ul style="list-style-type: none"><li><input type="checkbox"/> Asegúrese de que Cable esta en la posición Sí en el menú Ajuste de Canal (página 22).</li><li><input type="checkbox"/> Ejecute Autoprogramación para añadir canales que actualmente no estén en la memoria (página 15).</li></ul>
<b>El control remoto no funciona</b>	<ul style="list-style-type: none"><li><input type="checkbox"/> Las baterías podrían estar bajas. Sustitúyalas (página 2).</li><li><input type="checkbox"/> Coloque el televisor a unos 90-120 cm o más de las luces fluorescentes.</li></ul>
<b>El televisor está sucio</b>	<ul style="list-style-type: none"><li><input type="checkbox"/> Limpie el televisor con un paño suave y seco. No utilice nunca disolventes fuertes como diluyentes o bencina, puesto que podría dañar el acabado de la unidad.</li></ul>
<b>Ha perdido el control remoto</b>	<ul style="list-style-type: none"><li><input type="checkbox"/> Puede utilizar los controles del panel de audio/video frontal para acceder al menú (página 2). Póngase en contacto con su proveedor Sony más cercano para solicitar un control remoto de repuesto.</li></ul>

*Si después de leer este manual de instrucciones, tiene más preguntas relacionadas con la utilización del televisor Sony, póngase en contacto con su proveedor Sony más cercano para recibir asistencia técnica.*

## Especificaciones

### Para todos los modelos (excepto los indicados)

Sistema de televisión	Estándar de televisión americana/NTSC (KV-14FV300, KV-21FM100) PAL-M/PAL-N/NTSC (KV-14FV300 con destino a Argentina)
Cobertura de canales	VHF: 2-13/UHF: 14-69/CATV: 1-125
Antena	Terminal de antena externa para VHF/UHF de 75 ohm
Tubo de imagen	Tubo FD Trinitron®
Requisitos de alimentación para todos los países excepto en donde se indique:	ca 120 V      60 Hz ca 220 V      50/60 Hz (Chile, Perú, Bolivia) ca 120 – 220 V      50/60 Hz (Argentina)
Accesorios incluidos	Baterías de tamaño AA (R6) (2) Control Remoto RM-Y172 (1) (KV-21FM100) RM-Y173 (1) (KV-14FV300) Antena dipolo (1) Convertidor (EAC-25) (1)
Accesorios opcionales	Cables de conexión VMC-810S/820S, VMC-720M, YC-YC-15V/30V, RK74A Mezclador EAC-66 U/V

#### KV-14FV300

Tamaño de la pantalla	Tamaño de pantalla visible: 330 mm (13 pulgadas) medido en diagonal Tamaño de pantalla real: 355,6 mm (14 pulgadas) medido en diagonal
Entradas/salidas	2 de video, 2 de audio 1 conector para audífonos 1Y, P <sub>B</sub> , P <sub>R</sub> , 1 audio
Salida de la bocina	3 W x 2
Consumo de energía para todos los países excepto en donde se indique:	100 W 95 W (Chile, Perú, Bolivia) 1 W en espera
Dimensiones (An./Al./Prof.):	407 x 340 x 411 mm (16 x 13 <sup>3</sup> / <sub>8</sub> x 16 <sup>1</sup> / <sub>8</sub> pulgadas)
Peso	12 kg (26 lbs. 7 oz.)

#### KV-21FM100

Tamaño de la pantalla	Tamaño de pantalla visible: 508 mm (20 pulgadas) medido en diagonal Tamaño de pantalla real: 533,4 mm (21 pulgadas) medido en diagonal
Entradas/salidas	2 de video, 2 de audio 1 conector para audífonos
Salida de la bocina	3 W x 2
Consumo de energía para todos los países excepto en donde se indique:	115 W 110 (Chile, Perú, Bolivia) 1 W en espera
Dimensiones (An./Al./Prof.):	592 x 466 x 494 mm (23 <sup>1</sup> / <sub>4</sub> x 18 <sup>3</sup> / <sub>8</sub> x 19 <sup>1</sup> / <sub>2</sub> pulgadas)
Peso	24,8 kg (54 lbs. 10 oz.)

El diseño y las especificaciones están sujetos a cambios sin previo aviso.



# Índice alfabético

## A

Autoprogramación 15, 22  
Auto SAP 21

## B

Bloquear o desbloquear 24  
Brillo 20

## C

Cable 22  
Canales Favoritos 22  
Caption Vision 26  
Características del televisor 1  
Color 20  
Conexiones  
    Cable y antena 4  
    Conexión de una cámara de video 10  
    Conexión de un reproductor de DVD 10  
    Conexión de los audífonos 11  
    Televisor y caja de cable 6  
    Televisor y receptor de satélite 8  
    Televisor, receptor de satélite y  
    videograbadora 9  
    Televisor y videograbadora 5  
    Televisor, videograbadora y caja de  
    cable 7  
Contraste 20  
Control remoto 13

## D

Demo (Demostración) 26  
DISPLAY (Despliegue) 14

## E

Especificaciones 29  
Etiqueta de Video 26

## F

Fijar Canal 22





## H

Hora Actual 25

## I

Instalación de baterías 2  
Interruptor MAIN POWER  
(Alimentación principal) 2  
Idioma 26

## M

Menús  
    Ajuste de Canal  22  
    Ajustes  26  
    Audio  21  
    Bloqueo de Canal  24  
    Timer (Reloj)  25  
    Video  20

## MTS

Auto SAP 21  
Estéreo 21  
Mono 21

## N

Nitidez 20  
Nombre del Canal 23

## O

Omitir/Añadir Canal 23

## P

Panel frontal del televisor 2  
Panel posterior del televisor 3

## R

Rotación 26

## S

Sistema de Color 26  
SLEEP (Apagado automático) 14  
Solución de problemas 27

## T

Temperatura del Color 20  
Timer 1 y Timer 2 (Reloj1 y Reloj2) 25  
Tinte 20

## V

VM 20











Corporación Sony Impreso en EE.UU.

# SERVICE MANUAL

# BA-6 CHASSIS

<u>MODEL NAME</u>	<u>REMOTE COMMANDER</u>	<u>DESTINATION</u>	<u>CHASSIS NO.</u>
<b>KV-13FS100</b>	RM-Y173	US	SCC-S61F-A
<b>KV-13FS100</b>	RM-Y173	CND	SCC-S59E-A
<b>KV-13FS110</b>	RM-Y173	US	SCC-S61E-A
<b>KV-13FS110</b>	RM-Y173	CND	SCC-S59F-A
<b>KV-14FV300</b>	RM-Y173	LATIN NORTH	SCC-S60M-A
<b>KV-14FV300</b>	RM-Y173	LATIN SOUTH	SCC-S60N-A

## CORRECTION- 1

SUBJECT: SCREEN (G2) INSTRUCTIONS

Correct the service manual as shown.  
File this Correction with the service manual.

 : Corrected Item

Section 2: Set-Up Adjustments (Page 13)  
2-4. Screen (G2) added Step #4 to instructions

TRINITRON® COLOR TELEVISION  
**SONY**®

### 2-2-3. DYNAMIC CONVERGENCE ADJUSTMENT

Before performing this adjustment, perform Horizontal and Vertical Static Convergence Adjustment.

1. Slightly loosen deflection yoke screw.
2. Remove deflection yoke spacers.
3. Move the deflection yoke for best convergence as shown below:

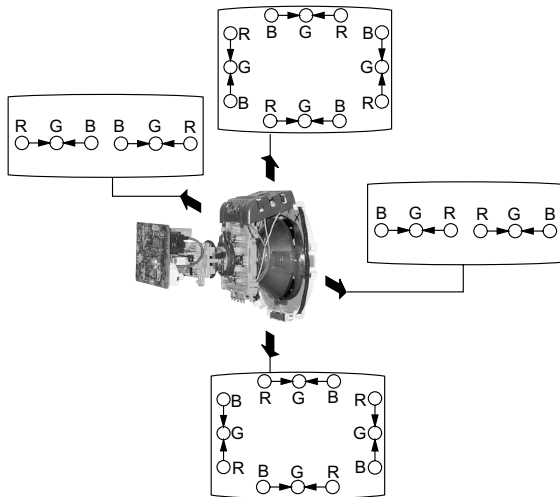

4. Tighten the deflection yoke screw.
5. Install the deflection yoke spacers.

### 2-2-4. TLH PLATE ADJUSTMENT

1. Input crosshatch pattern.
2. Adjust PICTURE QUALITY to standard, PICTURE and BRIGHTNESS to 50%, and OTHER to standard.
3. Adjust the Horizontal Convergence of red and blue dots by tilting the TLH plate on the deflection yoke.

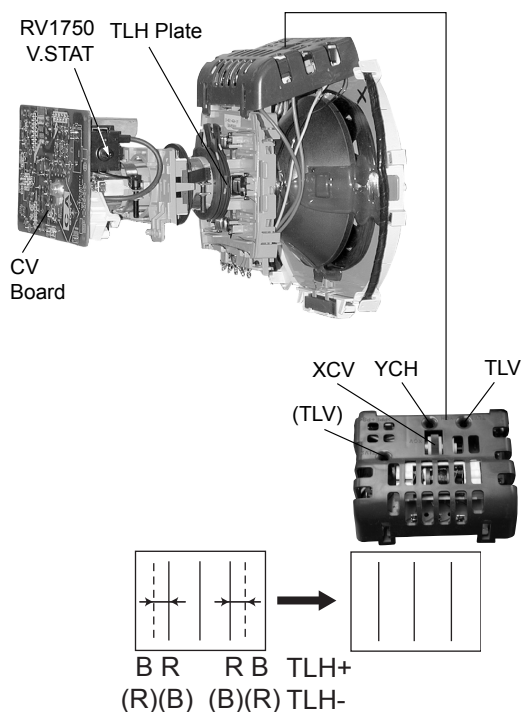

4. Adjust XCV core to balance X axis.
5. Adjust YCH VR to balance Y axis.
6. Adjust vertical red and blue convergence with V.TILT (TLV VR.)  
Note: Perform adjustment 3-6 while tracking items 1 and 2.

### 2-2-5. SCREEN-CORNER CONVERGENCE

1. Affix a permalloy assembly corresponding to the misconverged areas:

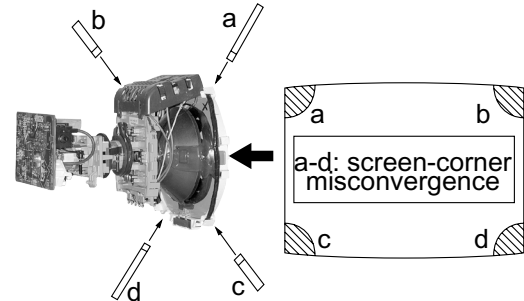

### 2-3. FOCUS

1. Adjust FOCUS control for best pictures.

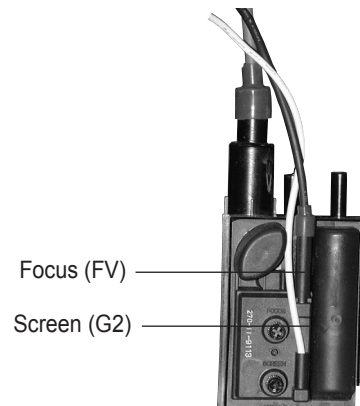

### 2-4. SCREEN (G2)

1. Input a dot pattern.
2. Set the PICTURE and BRIGHTNESS controls at minimum and COLOR control at normal.
3. Adjust SBRT, GCUT, BCUT in service mode with an oscilloscope as shown below so that voltages on the red, green, and blue cathodes are  $160 \pm 2\text{VDC}$ .

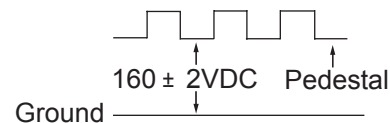

4. Observe the screen and adjust SCREEN (G2) VR in FBT to obtain the faintly visible background of dot signal.

9-965-931-91

**Sony Corporation**  
Sony Technology Center  
Technical Services  
Service Promotion Department

English  
2002IJ74WEB-1  
Printed in USA  
© 2002.9

# SERVICE MANUAL

# BA-6 CHASSIS

<u>MODEL NAME</u>	<u>REMOTE COMMANDER</u>	<u>DESTINATION</u>	<u>CHASSIS NO.</u>
<b>KV-13FS100</b>	RM-Y173	US	SCC-S61F-A
<b>KV-13FS100</b>	RM-Y173	CND	SCC-S59E-A
<b>KV-13FS110</b>	RM-Y173	US	SCC-S61E-A
<b>KV-13FS110</b>	RM-Y173	CND	SCC-S59F-A
<b>KV-14FV300</b>	RM-Y173	LATIN NORTH	SCC-S60M-A
<b>KV-14FV300</b>	RM-Y173	LATIN SOUTH	SCC-S60N-A

## CORRECTION- 2

SUBJECT: REPLACED A BOARD TRANSISTOR VOLTAGE LIST (Q600, Q601)  
REPLACED A BOARD IC VOLTAGE LIST (IC600)

Correct the service manual as shown.  
File this Correction with the service manual.

 : Corrected Items

### SECTION 5: DIAGRAMS

#### 5-3. BLOCK DIAGRAM AND SCHEMATICS

A Board Transistor Voltage List (Page 31)

A Board IC Voltage List (Page 31)

TRINITRON® COLOR TELEVISION  
**SONY**®



## SECTION 5: DIAGRAMS

## 5-3. BLOCK DIAGRAM AND SCHEMATICS (Page 31)

**A BOARD TRANSISTOR VOLTAGE LIST**

	<b>B</b>	<b>C</b>	<b>E</b>		<b>B</b>	<b>C</b>	<b>E</b>
<b>Q002</b>	0.0	2.0	GND	<b>Q405</b>	0.0	0.0	GND
<b>Q004</b>	3.8	9.0	4.4	<b>Q411</b>	0.0	5.8	GND
<b>Q005</b>	5.1	0.8	5.0	<b>Q412</b>	0.1	0.1	GND
<b>Q006</b>	0.0	0.0	GND	<b>Q435</b>	0.0	GND	5.8
<b>Q008</b>	0.0	2.6	GND	<b>Q501</b>	0.0	14.3	GND
<b>Q009</b>	0.0	5.2	GND	<b>Q502</b>	0.0	74.1	GND
<b>Q301</b>	3.6	2.1	3.6	<b>Q506</b>	0.0	131.8	0.0
<b>Q303</b>	3.6	GND	2.8	<b>Q521</b>	0.0	3.8	GND
<b>Q304</b>	3.6	GND	2.9	<b>Q522</b>	0.1	-2.1	0.0
<b>Q305</b>	3.6	GND	3.0	<b>Q572</b>	0.0	2.6	GND
<b>Q306</b>	5.5	GND	4.9	<b>Q573</b>	2.6	0.0	2.6
<b>Q390</b>	0.8	1.5	1.9	<b>Q578</b>	0.0	0.5	GND
<b>Q391</b>	0.6	3.3	1.5	<b>Q590</b>	133.7	0.0	134.2
<b>Q400</b>	0.0	0.1	GND	<b>Q604</b>	30.6	11.6	30.2
<b>Q401</b>	0.0	0.1	GND	<b>Q608</b>	0.0	6.7	GND
<b>Q404</b>	0.0	0.0	GND	<b>Q650</b>	5.8	9.0	5.0

All voltages are in V.

	<b>D</b>	<b>G</b>	<b>S</b>
 <b>Q600</b>	340.0	160.0	156.0
 <b>Q601</b>	155.0	4.9	0.0

## SECTION 5: DIAGRAMS

## 5-3. BLOCK DIAGRAM AND SCHEMATICS (Page 31)

## A BOARD IC VOLTAGE LIST

IC001		44	1.6	7	GND	3	-12.2	13	NC
PIN	VOLT	45	1.6	8	5.0	4	-13.3	14	163.9
1	N/C	46	2.3	IC003		5	0.2	15	153.8
2	GND	47	1.0	PIN	VOLT	6	13.8	16	158.2
3	2.2	48	N/C	1	N/C	7	0.7	17	NC
4	2.2	49	0.5	2	GND	IC561		18	340.0
5	GND	50	1.2	3	GND	PIN	VOLT	IC603	
6	5.0	51	2.0	4	5.0	1	0.1	PIN	VOLT
7	0.0	52	1.5	5	5.0	2	3.4	I	12.0
8	2.0	53	4.8	IC401		3	2.3	G	GND
9	0.3	54	4.8	PIN	VOLT	4	GND	O	9.0
10	2.1	55	4.8	1	4.5	5	9.2	IC604	
11	5.0	56	4.8	2	0.3	6	10.2	PIN	VOLT
12	GND	57	N/C	3	4.5	7	0.1	1	133.7
13	3.3	58	5.2	4	0.3	8	13.5	2	N/C
14	3.1	59	0.0	5	4.5	IC565		3	2.5
15	1.0	60	0.0	6	4.5	PIN	VOLT	4	11.3
16	1.5	61	0.0	7	0.0	1	3.4	5	GND
17	3.3	62	0.0	8	4.5	2	3.4	IC608	
18	0.5	63	1.4	9	4.5	3	2.1	PIN	VOLT
19	1.1	64	4.9	10	N/C	4	9.0	I	11.0
20	GND	65	4.9	11	4.4	5	1.0	O	5.0
21	0.5	66	0.0	12	0.0	6	1.0	G	GND
22	1.7	67	0.1	13	4.5	7	1.0	IC633	
23	0.5	68	0.1	14	9.0	8	1.6	PIN	VOLT
24	0.5	69	2.4	15	4.4	9	1.6	I	9.0
25	0.5	70	5.0	16	GND	10	1.6	G	GND
26	0.0	71	5.0	IC404		11	GND	O	3.3
27	0.0	72	0.1	PIN	VOLT	12	1.6	All voltages are in V.	
28	2.1	73	0.0	1	14.6	13	1.6		
29	2.7	74	5.0	2	7.0	14	1.6		
30	3.3	75	5.0	3	GND	IC600		☞	
31	2.9	76	5.0	4	7.0	PIN	VOLT		
32	GND	77	0.1	5	5.9	1	2.8		
33	2.8	78	0.0	6	0.0	2	1.9		
34	3.3	79	4.9	7	GND	3	2.3		
35	2.9	80	4.9	8	0.0	4	2.6		
36	GND	IC002		9	0.5	5	GND		
37	1.8	PIN	VOLT	10	7.2	6	0.0		
38	0.0	1	GND	11	GND	7	4.6		
39	0.1	2	GND	12	7.0	8	17.5		
40	2.0	3	GND	IC545		9	0.0		
41	1.6	4	GND	PIN	VOLT	10	10.6		
42	3.3	5	4.8	1	0.7	11	0.0		
43	N/C	6	4.8	2	13.5	12	4.9		

Sony Corporation  
 Sony Technology Center  
 Technical Services  
 Service Promotion Department

English  
 2003DJ74WEB-1  
 Printed in USA  
 © 2003.4

# SERVICE MANUAL

# BA-6 CHASSIS

<u>MODEL NAME</u>	<u>REMOTE COMMANDER</u>	<u>DESTINATION</u>	<u>CHASSIS NO.</u>
<b>KV-13FS100</b>	RM-Y173	US	SCC-S61F-A
<b>KV-13FS100</b>	RM-Y173	CND	SCC-S59E-A
<b>KV-13FS110</b>	RM-Y173	US	SCC-S61E-A
<b>KV-13FS110</b>	RM-Y173	CND	SCC-S59F-A
<b>KV-14FV300</b>	RM-Y173	LATIN NORTH	SCC-S60M-A
<b>KV-14FV300</b>	RM-Y173	LATIN SOUTH	SCC-S60N-A

## CORRECTION-3

SUBJECT: REPLACED A BOARD SCHEMATIC TO CORRECT  
T603 PIN CONNECTION

Correct the service manual as shown.  
File this Correction with the service manual.

 : Corrected Items

### SECTION 5: DIAGRAMS

#### 5-3. BLOCK DIAGRAM AND SCHEMATICS

A Board Schematic (Page 31)



5-4. SCHEMATIC DIAGRAMS AND SUPPORTING INFORMATION

A BOARD SCHEMATIC DIAGRAM

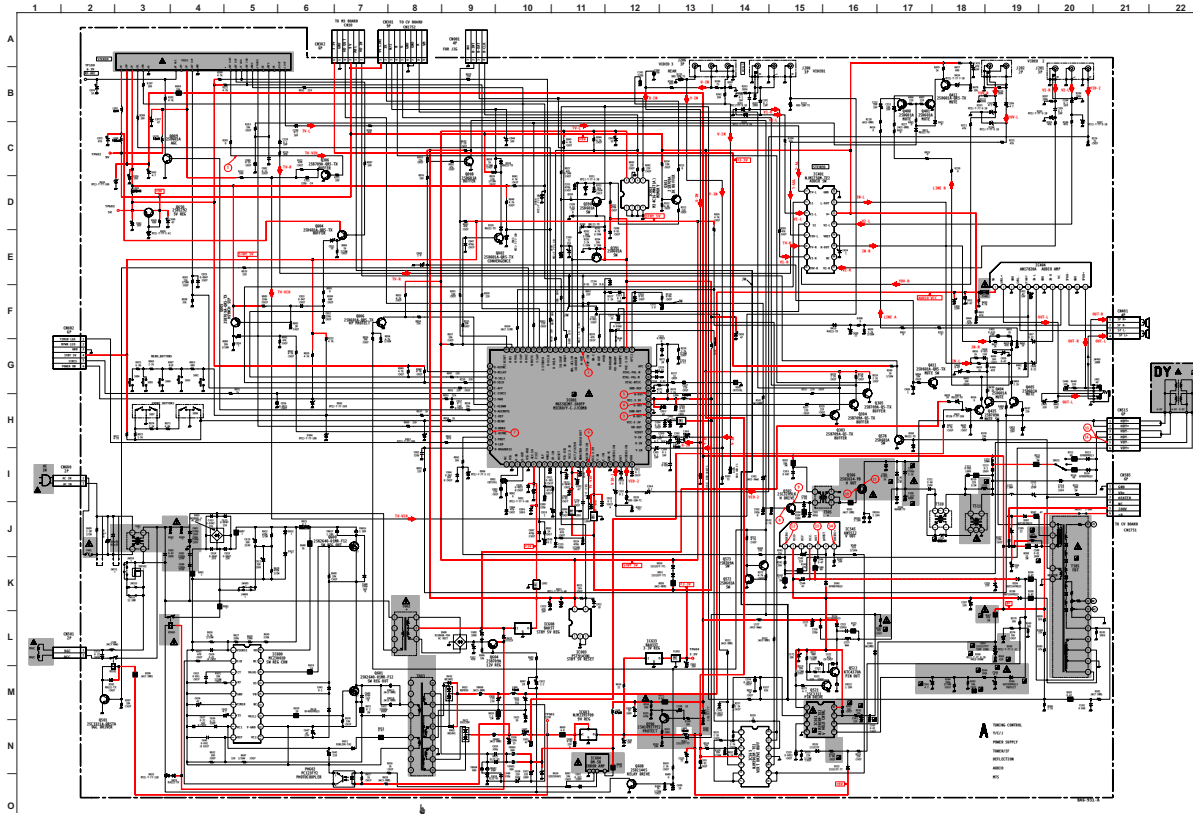

A BOARD WAVEFORMS

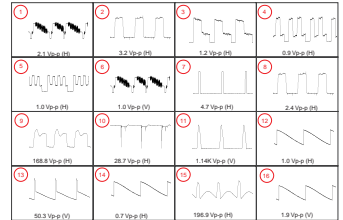

A BOARD IC VOLTAGE LIST

IC	Pin	VOLT	IC	Pin	VOLT	IC	Pin	VOLT		
IC501	44	1.6	IC502	7	GND	IC503	12.2	13	NC	
IC504	45	1.6	IC505	6	0.0	IC506	11	13.5	14	15.5
IC507	46	2.3	IC508	5	0.2	IC509	15	15.5	16	15.5
IC510	47	1.0	IC511	4	0.0	IC512	17	NC	18	15.0
IC513	48	0.5	IC514	3	GND	IC515	18	15.0	19	15.0
IC516	49	0.5	IC517	2	GND	IC518	19	15.0	20	15.0
IC519	50	1.2	IC520	1	0.1	IC521	20	15.0	21	15.0
IC522	51	2.0	IC523	0	0.0	IC524	21	15.0	22	15.0
IC525	52	4.8	IC526	0	0.0	IC527	22	15.0	23	15.0
IC528	53	4.8	IC529	0	0.0	IC530	23	15.0	24	15.0
IC531	54	4.8	IC532	0	0.0	IC533	24	15.0	25	15.0
IC534	55	4.8	IC535	0	0.0	IC536	25	15.0	26	15.0
IC537	56	4.8	IC538	0	0.0	IC539	26	15.0	27	15.0
IC540	57	4.8	IC541	0	0.0	IC542	27	15.0	28	15.0
IC543	58	5.2	IC544	0	0.0	IC545	28	15.0	29	15.0
IC546	59	5.2	IC547	0	0.0	IC548	29	15.0	30	15.0
IC549	60	5.2	IC550	0	0.0	IC551	30	15.0	31	15.0
IC552	61	5.2	IC553	0	0.0	IC554	31	15.0	32	15.0
IC555	62	5.2	IC556	0	0.0	IC557	32	15.0	33	15.0
IC558	63	5.2	IC559	0	0.0	IC560	33	15.0	34	15.0
IC561	64	5.2	IC562	0	0.0	IC563	34	15.0	35	15.0
IC564	65	5.2	IC565	0	0.0	IC566	35	15.0	36	15.0
IC567	66	5.2	IC568	0	0.0	IC569	36	15.0	37	15.0
IC570	67	5.2	IC571	0	0.0	IC572	37	15.0	38	15.0
IC573	68	5.2	IC574	0	0.0	IC575	38	15.0	39	15.0
IC576	69	5.2	IC577	0	0.0	IC578	39	15.0	40	15.0
IC579	70	5.2	IC580	0	0.0	IC581	40	15.0	41	15.0
IC582	71	5.2	IC583	0	0.0	IC584	41	15.0	42	15.0
IC585	72	5.2	IC586	0	0.0	IC587	42	15.0	43	15.0
IC588	73	5.2	IC589	0	0.0	IC590	43	15.0	44	15.0
IC591	74	5.2	IC592	0	0.0	IC593	44	15.0	45	15.0
IC594	75	5.2	IC595	0	0.0	IC596	45	15.0	46	15.0
IC597	76	5.2	IC598	0	0.0	IC599	46	15.0	47	15.0
IC600	77	5.2	IC601	0	0.0	IC602	47	15.0	48	15.0
IC603	78	5.2	IC604	0	0.0	IC605	48	15.0	49	15.0
IC606	79	5.2	IC607	0	0.0	IC608	49	15.0	50	15.0
IC609	80	5.2	IC610	0	0.0	IC611	50	15.0	51	15.0
IC612	81	5.2	IC613	0	0.0	IC614	51	15.0	52	15.0
IC615	82	5.2	IC616	0	0.0	IC617	52	15.0	53	15.0
IC618	83	5.2	IC619	0	0.0	IC620	53	15.0	54	15.0
IC621	84	5.2	IC622	0	0.0	IC623	54	15.0	55	15.0
IC624	85	5.2	IC625	0	0.0	IC626	55	15.0	56	15.0
IC627	86	5.2	IC628	0	0.0	IC629	56	15.0	57	15.0
IC630	87	5.2	IC631	0	0.0	IC632	57	15.0	58	15.0
IC633	88	5.2	IC634	0	0.0	IC635	58	15.0	59	15.0
IC636	89	5.2	IC637	0	0.0	IC638	59	15.0	60	15.0
IC639	90	5.2	IC640	0	0.0	IC641	60	15.0	61	15.0
IC642	91	5.2	IC643	0	0.0	IC644	61	15.0	62	15.0
IC645	92	5.2	IC646	0	0.0	IC647	62	15.0	63	15.0
IC648	93	5.2	IC649	0	0.0	IC650	63	15.0	64	15.0
IC651	94	5.2	IC652	0	0.0	IC653	64	15.0	65	15.0
IC654	95	5.2	IC655	0	0.0	IC656	65	15.0	66	15.0
IC657	96	5.2	IC658	0	0.0	IC659	66	15.0	67	15.0
IC660	97	5.2	IC661	0	0.0	IC662	67	15.0	68	15.0
IC663	98	5.2	IC664	0	0.0	IC665	68	15.0	69	15.0
IC666	99	5.2	IC667	0	0.0	IC668	69	15.0	70	15.0
IC669	100	5.2	IC670	0	0.0	IC671	70	15.0	71	15.0
IC672	101	5.2	IC673	0	0.0	IC674	71	15.0	72	15.0
IC675	102	5.2	IC676	0	0.0	IC677	72	15.0	73	15.0
IC678	103	5.2	IC679	0	0.0	IC680	73	15.0	74	15.0
IC681	104	5.2	IC682	0	0.0	IC683	74	15.0	75	15.0
IC684	105	5.2	IC685	0	0.0	IC686	75	15.0	76	15.0
IC687	106	5.2	IC688	0	0.0	IC689	76	15.0	77	15.0
IC690	107	5.2	IC691	0	0.0	IC692	77	15.0	78	15.0
IC693	108	5.2	IC694	0	0.0	IC695	78	15.0	79	15.0
IC696	109	5.2	IC697	0	0.0	IC698	79	15.0	80	15.0
IC699	110	5.2	IC700	0	0.0	IC701	80	15.0	81	15.0
IC702	111	5.2	IC703	0	0.0	IC704	81	15.0	82	15.0
IC705	112	5.2	IC706	0	0.0	IC707	82	15.0	83	15.0
IC708	113	5.2	IC709	0	0.0	IC710	83	15.0	84	15.0
IC711	114	5.2	IC712	0	0.0	IC713	84	15.0	85	15.0
IC714	115	5.2	IC715	0	0.0	IC716	85	15.0	86	15.0
IC717	116	5.2	IC718	0	0.0	IC719	86	15.0	87	15.0
IC720	117	5.2	IC721	0	0.0	IC722	87	15.0	88	15.0
IC723	118	5.2	IC724	0	0.0	IC725	88	15.0	89	15.0
IC726	119	5.2	IC727	0	0.0	IC728	89	15.0	90	15.0
IC729	120	5.2	IC730	0	0.0	IC731	90	15.0	91	15.0
IC732	121	5.2	IC733	0	0.0	IC734	91	15.0	92	15.0
IC735	122	5.2	IC736	0	0.0	IC737	92	15.0	93	15.0
IC738	123	5.2	IC739	0	0.0	IC740	93	15.0	94	15.0
IC741	124	5.2	IC742	0	0.0	IC743	94	15.0	95	15.0
IC744	125	5.2	IC745	0	0.0	IC746	95	15.0	96	15.0
IC747	126	5.2	IC748	0	0.0	IC749	96	15.0	97	15.0
IC750	127	5.2	IC751	0	0.0	IC752	97	15.0	98	15.0
IC753	128	5.2	IC754	0	0.0	IC755	98	15.0	99	15.0
IC756	129	5.2	IC757	0	0.0	IC758	99	15.0	100	15.0
IC759	130	5.2	IC760	0	0.0	IC761	100	15.0	101	15.0
IC762	131	5.2	IC763	0	0.0	IC764	101	15.0	102	15.0
IC765	132	5.2	IC766	0	0.0	IC767	102	15.0	103	15.0
IC768	133	5.2	IC769	0	0.0	IC770	103	15.0	104	15.0
IC771	134	5.2	IC772	0	0.0	IC773	104	15.0	105	15.0
IC774	135	5.2	IC775	0	0.0	IC776	105	15.0	106	15.0
IC777	136	5.2	IC778	0	0.0	IC779	106	15.0	107	15.0
IC780	137	5.2	IC781	0	0.0	IC782	107	15.0	108	15.0
IC783	138	5.2	IC784	0	0.0	IC785	108	15.0	109	15.0
IC786	139	5.2	IC787	0	0.0	IC788	109	15.0	110	15.0
IC789	140	5.2	IC790	0	0.0	IC791	110	15.0	111	15.0
IC792	141	5.2	IC793	0	0.0	IC794	111	15.0	112	15.0
IC795	142	5.2	IC796	0	0.0	IC797	112	15.0	113	15.0
IC798	143	5.2	IC799	0	0.0	IC800	113	15.0	114	15.0
IC801	144	5.2	IC802	0	0.0	IC803	114	15.0	115	15.0
IC804	145	5.2	IC805	0	0.0	IC806	115	15.0	116	15.0
IC807	146	5.2	IC808	0	0.0	IC809	116	15.0	117	15.0
IC810	147	5.2	IC811	0	0.0	IC812	117	15.0	118	15.0
IC813	148	5.2	IC814	0	0.0	IC815	118	15.0	119	15.0
IC816	149	5.2	IC817	0	0.0	IC818	119	15.0	120	15.0
IC819	150	5.2	IC820	0	0.0	IC821	120	15.0	121	15.0
IC822	151	5.2	IC823	0	0.0	IC824	121	15.0	122	15.0
IC825	152	5.2	IC826	0	0.0	IC827	122	15.0	123	15.0
IC828	153	5.2	IC829	0	0.0	IC830	123	15.0	124	15.0
IC831	154	5.2	IC832	0	0.0	IC833	124	15.0	125	15.0
IC834	155	5.2	IC835	0	0.0	IC836	125	15.0	126	15.0
IC837	156	5.2	IC838	0	0.0	IC839	126	15.0	127	15.0
IC840	157	5.2	IC841	0	0.0	IC842	127	15.0	128	15.0
IC843	158	5.2	IC844	0	0.0	IC845	128	15.0	129	15.0
IC846	159	5.2	IC847	0	0.0	IC848	129	15.0	130	15.0
IC849	160	5.2	IC850	0	0.0	IC851	130	15.0	131	15.0
IC852	161	5.2	IC853	0	0.0	IC854	131	15.0	132	15.0
IC855	162	5.2	IC856	0	0.0	IC857	132	15.0	133	15.0
IC858	163	5.2	IC859	0	0.0	IC860	133	15.0	134	15.0
IC861	164	5.2	IC862	0	0.0	IC863	134	15.0	135	15.0
IC864	165	5.2	IC865	0	0.0	IC866	135	15.0	136	15.0
IC867	166	5.2	IC868	0	0.0	IC869	136	15.0	137	15.0
IC870	167	5.2	IC871	0	0.0	IC872	137	15.0	138	15.0
IC873	168	5.2	IC874	0	0.0	IC875	138	15.0	139	15.0
IC876	169	5.2	IC877	0	0.0	IC8				